

CATÁLOGO

TARIFA

CATALOGUE
RATE

*CATALOGUE
TARIF*



SACOPISA

EQUIPAMIENTO ALIMENTACIÓN Y HOSTELERÍA



QUIENES SOMOS

Somos una empresa española de carácter familiar creada en 1972, situada a 20 km. de Barcelona, dedicada a la fabricación y distribución de equipamiento para la industria alimentaria y el sector hostelero.

HISTORIA

En nuestros inicios, nos dedicamos en exclusiva al tratamiento de la madera para el sector de la alimentación y la hostelería, concretamente, a la fabricación de tajos y pilones. Esta especialización durante años nos ha convertido en el líder de estos productos en España. Más tarde, empezamos a trabajar también con polietileno, para responder a las necesidades del mercado. Introdujimos asimismo toda la gama de accesorios y maquinaria que completan la gama de productos necesarios en nuestro sector: picadoras, carteles, cuchillos, envasadoras, bandejas... y un largo etcétera hasta llegar a un total de más de 2500 referencias que se pueden encontrar en nuestro catálogo, en continua evolución para incorporar las novedades que vamos recogiendo en los diferentes mercados internacionales del sector.

EXPANSIÓN INTERNACIONAL

Nuestra inquietud por innovar nos lleva a visitar y exponer en las principales ferias del sector en Europa y otras partes del mundo, para conocer los avances del sector. De hecho, actualmente exportamos a CEE, Norte de África, Emiratos y Sudamérica.

OBJETIVO

Nuestro propósito es ofrecer un servicio de calidad con eficacia y rapidez y asesorar adecuadamente a nuestros clientes para adaptarnos a sus características particulares.

ABOUT US

We are a Spanish family company established in 1972, located 20 km. Barcelona, dedicated to the manufacture and distribution of equipment for the food industry and the hospitality industry.

HISTORY

In our beginnings, we are dedicated exclusively to the treatment of wood for the food industry and catering specifically to the manufacture of gashes and pylons. This specialization for years has made us the leader of these products in Spain. Later, we began to also work with polyethylene to meet market needs. We introduced the full range of accessories and machinery which complete the range of products needed in our industry: grinding machines, tags, knives, packaging, trays... and so on until a total of more than 2500 references that can be found in our catalog, constantly evolving to incorporate new features that we collect in various international markets sector.

INTERNATIONAL EXPANSION

Our concern for innovation leads us to visit and exhibit at the main trade fairs in Europe and other parts of the world, to the progress of the sector. In fact, we currently export to CEE, North Africa, Emirates and South America.

OBJECTIVE

Our purpose is to offer a quality service efficiently and quickly and properly advise our clients to suit their particular characteristics.

QUI SOMMES NOUS

Nous sommes une entreprise familiale espagnole établie en 1972, situé à 20 km. Barcelone, dédiée à la fabrication et la distribution d'équipements pour l'industrie alimentaire et l'industrie hôtelière.

HISTOIRE

Dans nos débuts, nous nous consacrons exclusivement au traitement du bois pour l'industrie alimentaire et de la restauration en particulier à la fabrication de estafilades et des pylônes. Cette spécialisation des années a fait de nous le leader de ces produits en Espagne. Plus tard, nous avons commencé à travailler également avec du polyéthylène, pour répondre aux besoins du marché. également introduit la gamme complète d'accessoires et de machines qui complètent la gamme de produits nécessaires dans notre industrie: déchiqueuses, des affiches, des couteaux, des emballageuses, des plateaux... et ainsi de suite jusqu'à un total de plus de 2500 références qui peuvent être trouvés dans notre catalogue, en constante évolution pour intégrer de nouvelles fonctionnalités que nous recueillons dans divers secteurs des marchés internationaux.

EXPANSION INTERNATIONALE

Notre souci d'innovation nous amène à visiter et d'exposer les principales foires commerciales en Europe et d'autres parties du monde, les progrès du secteur. En fait, nous exportons actuellement CEE, Afrique du Nord, Emirates et Amérique du Sud.

OBJECTIF

Notre but est d'offrir un service de qualité efficacement et rapidement et correctement conseiller nos clients en fonction de leurs caractéristiques particulières.

0 1

Tajos, Tacos sobre mostrador, Pilones, Trípodes, Polietileno, Mesas de madera, Mesas acero-inox, Complementos, Polietileno mesa-cocina, Palas polietileno, Soportes tablas polietileno.

Chopping block tables, cutting boards on counters, Polyethylene, Wooden tables, Stainless steel tables, Accessories, Kitchen table polyethylene, Polyethylene utility paddles, Polyethylene board stand.

Billots de boucher, Blocs sur comptoir, Polyéthylènes, Tables en bois, Tables en acier-inox, Accessoires, Poléthylène table-cuisine, Pelles polyéthylène, Supports table polyéthylène.

1 - 20

0 2

Carteles portaprecios, Peana - Plataformas - Pinzas, Listas de precios, Carteles señalización, Guirnalda, Separadores, Barreños, Base rodante, Cubetas, Bandejas, Gastronorm, PlexiLine.

Price tag holder, Stand - platforms - Clips, Price lists, Signs, Garlands, Separators, Tubs, Rolling base, Containers, Trays, Gastronorm, PlexiLine.

Affiches porte prix, Socle - plate-formes - clips, Liste prix, Affiches signalization, Guirlandes, Séparateurs, Bassines, Base roulante, Bacs, Plateaux, Gastronorm, PlexiLine.

21 - 62

0 3

Picadoras, Picadora refrigerada, Cuchillas Placas, Empujadores picadoras, Cortadoras, Ralladora, Exprimidor, Cortadora multifunción, Enternecedor de carne, Cutters, Molino, Afiladoras.

Mincers, Refrigerated mincers, Blades Plates, Mincer pusher, Slicer, Grater, Juicer, Multi-purpose slicer, Meat tenderizer, Cutters, Mill, Sharpener.

Hachoirs, Hachoirs réfrigérés, Lames plaques, Poussoir hachoirs, Trancheuse, Râpes, Presse, Decoupoir multifonction, Attendrissant, Cutter, Moulin, Aiguiseur.

63 - 86

0 4

Maquinas retractilar, Film, Dispensadores de film, Dispensador papel aluminio, Soldadoras de bolsas, Máquina sellar, Máquina vacío, Parrilla envasadora, Bolsas vacío, Termoselladora.

Wrapping machines, Film, Film dispensers, Aluminium foil dispenser, Bag sealer, Sealer machine, Vacuum machine, Packaging grill, Vacuum bags, Thermo sealer.

Machine à retractiler, Film, Dispensateurs film, Dispensateur papier aluminium, Scelleuse de sacs, Machine à sceller, Machines vide, Grill à emballer, Sacs sous vide, Thermo machine.

87 - 100

0 5

Secamanos, Dispensadores papel celulosa, Papel celulosa, Dosificadores jabón, Grifos-caño electrónico, Grifos ducha, Lavamanos, Portacuchillos-Papeleras, Esterilizadores de cuchillos, Contenedores plástico, Contenedores papeleras acero-inoxidable.

Hand dryer, Cellulose paper dispenser, Cellulose paper, Soap dispensers, Tap with electronic spout, Shower tap, Washbasin, Knife Holder-Waste baskets, Knives sterilizer, Plastic container, Stainless steel containers-bins.

Sèche-mains, Dispensateur papier cellulose, Papier cellulose, Doseurs de savon, Robinet électronique, Robinet douche, Lave-mains, Porte couteaux-Poubelles, stérilisateur de couteaux, Conteneurs plastique, Conteneur-poubelle acier inox.

101 - 120

0 6

Indicadores de turno, Expendedores de tickets, Rollos tickets, Exterminadores de insectos, Detector contador billetes - monedas.

Queue indicators, Ticket dispenser, Ticket roll, Insect exterminator, Counter detector bill - coin.

Indicateur de numero, Dispensateur tickets, Rouleaux de tickets, Exterminateur d'insectes, Compteur détecteur billets - monnaie.

121 - 134

0 7

Hamburgueseras, Papel celofán, Embutidoras, Jamoneras, Ganchos, Libradores, Pinzas, Molde brochetas, Enternecedor carne, Malla y anillas elásticas, Protector hueso.

Hamburger presses, Cellophane foil, Sausage filler, Jamoneras, Hooks, Scoops, Tongs, Brochette mold, Meat tenderizer, Elastic mesh and rings, Bone protector.

Hachoirs, Papiers cellophane, Emboutisseuses, Jamoneras, Crochets, Pelles à main, Pincas, Moule brochettes, Attendrisseur, Maille et anneaux élastiques, Protecteur d'os.

135 - 148

0 8

Cierra bolsas-rollos, Etiquetadoras-rollos, Naveteadoras, Caja cobro, Espejos vigilancia, Carro servicio - Bandejero, Cestos - carros autoservicio, Dispensadores bolsas.

Bag-roll sealer, Labellers-rolls, Labelling gun, Cash box, Vigilance mirror, Service trolley - tray, Self-service basket - trolley, Bags dispensers.

Machines ferme sacs, Étiquetteuses-rolls, Pistolet à étiqueter, Caisses entregistreuses, Miroir de surveillance, Chariot service - Plateau, Panier - chariot self-service, Dispensateurs sacs.

149 - 160

0 9

Cuchillería profesional, Afiladores, Chairas, Hachas, Tijeras, Espátulas, Bacaladera, Abre-Ostras, Sierras, Imanes, Guillotinas queso, Sacacorchos, Abrelatas, Guantes, Delantales, Material de un uso.

Professional knives, Sharpeners, Axes, Scissors, Spatulas, Fish shears, Oyster sucker, Saws, Magnets, Cheese guillotines, Corkscrew, Can openers, Gloves, Aprons, Disposable material.

Couteaux professionnels, Aiguiseurs, Scies, Ciseaux, Spatules, Morutiel manuel, Couteau à huîtres, Scies, Aimants, Guillotines à fromage, Tire-Bouchon, Ouvre-Boîtes, Gants, Tabliers, Material d'un seul usage.

161 - 182

1 0

Estanterías, Plataformas, Tarima antifatiga, Palets, Losetas, Bancos de vestuario, Taquillas.

Shelves, Platforms, Anti-fatigue mat, Pallets, Tiles, Locker room bench, Lockers.

Étagères, Plate-formes, Sol anti-fatigue, Palettes, Carreaux, Banc vestiare, Casiers.

183 - 196

Recambios / Spare Parts / Pieces de Rechange

Carteles portaprecios, Guantes acero-inox, Indicadores de turno, Grifos ducha, Soldadores de bolsa, Esterilizadores, Máquinas retractilar, Máquinas cierra bolsas, Hamburgueseras, Máquinas cierra bolsas, Etiquetadoras, Abrelatas, Exterminadores-tubos.

Tag holders, Stainless steel gloves, Queue indicators, Shower taps, Bag sealers, Sterilisers, Wrapping machines, Burger presses, Labellers, Can opener, Insect exterminators-tubes.

Affiches porte-prix, Gants d'inox, Indicateurs de tour, Robinets douche, Scelleuse de sacs, Stérilisateurs, Machines à retractiler, Machine ferme sacs, Hachoirs, Étiquetteuses, Ouvre-boîtes, Exterminateurs d'insectes-tubes.

197 - 202



SUBDIRECCIÓN GENERAL
DE GESTIÓN DE RIESGOS
ALIMENTARIOS
REGISTRO GENERAL
SANITARIO DE ALIMENTOS

71

1.	Nombre o Razon Social SACOPISA S.L.		
2.	Domicilio Social C/ VALLES 5 (POL. IND. CAN CASABLANCAS) SANT QUIRZE DEL VALLES BARCELONA		
3.	Actividad de la Industria FABRICACION Y/O ELABORACION Y/O TRANSFORMACION DE MATERIAS PLASTICAS FABRICACION Y/O ELABORACION Y/O TRANSFORMACION DE MADERA, CORCHO, CUERO, PIELS Y FIBRAS NATURALES		
4.	Domicilio Industrial C/ VALLES 5 (POL. IND. CAN CASABLANCAS) SANT QUIRZE DEL VALLES BARCELONA		
5.	Clave 39	Catg. / Act./s 0101, 0109	Núm. Registro Sanitario 39.04434/B

De conformidad con lo dispuesto en el artículo segundo del Real Decreto 1712/1991, de 29 de noviembre (B.O.E. de 4 de diciembre), y a tenor de la autorización concedida, ha quedado inscrita la industria de referencia en el Registro General Sanitario de Alimentos con el número arriba indicado.

Madrid, 22 de Octubre de 2010

EL TÉCNICO SUPERIOR



REGISTRO GENERAL SANITARIO
DE ALIMENTOS

Miguel Ángel Casas Paulet

AREA DE AUTORIZACIONES Y REGISTROS (DIVISION DE GESTION DE RIESGOS)
AGENCIA DE PROTECCION DE LA SALUD
BARCELONA

SACOPISA SL
Polígon Industrial Can Casablanques sortida
CR Vallès, 5
08192 SANT QUIRZE DEL VALLÈS

D'acord amb la sol·licitud presentada i havent tramitat l'expedient corresponent, ha quedat **ACTUALITZADA** la situació de l'empresa de referència en el Registre sanitari d'indústries i productes alimentaris de Catalunya (RSIPAC), amb les dades següents:

*De conformidad con la solicitud presentada y tramitado el expediente correspondiente, ha quedado **ACTUALIZADA** la situación de la empresa de referencia en el Registro Sanitario de Industrias y Productos Alimentarios de Cataluña (RSIPAC), con los datos siguientes:*

IDENTIFICACIÓ DE L'EMPRESA/IDENTIFICACIÓN DE LA EMPRESA

Raó social/razón social NIF/NIE/CIF
SACOPISA SL B60206810

Adreça social/domicilio social
Polígon Industrial Can Casablanques
CR Vallès, 5 X: 423992
08192 SANT QUIRZE DEL VALLÈS Y: 4600634

Adreça industrial/domicilio industrial
Polígon Industrial Can Casablanques
CR Vallès, 5 X: 423992
08192 SANT QUIRZE DEL VALLÈS Y: 4600634

Núm. RSIPAC: 39.05165/CAT Núm. RGSEAA: 39.04434/B

Data Inscripció/fecha inscripción: 07/09/2010

ACTIVITATS / ACTIVIDADES

Clau: 39

Codi	Descripció
01/01	Fabricació o elaboració o transformació de matèries plàstiques
01/09	Fabricació o elaboració o transformació de fusta, suro, cuir, pells i fibres naturals

Clave: 39

Código	Descripción
01/01	Fabricación o elaboración o transformación de materias plásticas
01/09	Fabricación o elaboración o transformación de madera, corcho, cuero, pieles y fibras naturales

Roc Boronat, 81-95
Barcelona . 93 551 39 00 / Fax 93 551 75 05
<http://www.gencat.cat/salut>

Document electrònic garantit amb signatura electrònica. Podeu verificar la integritat d'aquest document a l'adreça web
csv.gencat.cat

Original electrònic / Còpia autèntica

Doc.original signat per:
CPISR-1 Maria Alba Pascual
Cardona
12/07/2016

CODI SEGUR DE VERIFICACIÓ



01DBVIPDK3N0IMSEB1W8U23LY2J4NUHL

Data creació còpia:
13/07/2016
Data caducitat còpia:
13/07/2019
Pàgina 1 de 2



SACOPI SA
EQUIPAMIENTO ALIMENTACIÓN Y HOSTELERÍA

Declaración de conformidad

Mediante la emisión del siguiente certificado, SACOPI SA S.L., situada en el Polígono Industrial Can Casablanques calle Vallés nº5, declara que los productos mencionados a continuación:

- **Pilones;**
- **Tacos**
- **Tablas de corte;**
- **Tajos;**

Cumplen con los requisitos exigidos por el **Reglamento 1935/2004**, sobre materiales y objetos destinados a entrar en contacto con alimentos. Ante la falta de normativa regulatoria específica sobre madera declaramos que nuestros productos cumplen con los requisitos alemanes específicos para madera en contacto con alimentos regulados por la **LFGB** de manera que:

- Los niveles de migración de formaldehído;
- Los niveles de migración de DEPH, DBP i DiBP;
- Los niveles de migración de fenoles clorados PCP, TeCP, TriCP (GC-ECD);
- Los niveles de pesticidas básicos;

no suponen un riesgo para la salud humana ni alteran las características organolépticas del producto.

Con esto, declaramos que nuestros productos son **aptos para el contacto con alimentos** según la normativa actual y así lo ratifica mediante la siguiente firma:

Jordi Gálvez Alsina,

En calidad de gerente

Sant Quirze del Vallés, 23 de febrero del 2017



Reservamos el derecho a modificar ó alterar nuestros productos sin previo aviso. Los precios son válidos salvo error tipográfico o de impresión.

We reserve ourselves the right to modify our products without notice it previously.
Prices are valid except for typographical errors or printing.

*Nous réservons le droit de modifier nos produits sans préavis.
Les prix sont valables sauf erreur typographique ou d'impression.*

0

1

Tajos, Tacos sobre mostrador, Pilonos, Trípodes, Polietilenos, Mesas de madera, Mesas acero-inox, Complementos, Polietileno mesa-cocina, Palas polietileno, Soportes tablas polietileno.

Chopping block tables, cutting boards on counters, Polyethylene, Wooden tables, Stainless steel tables, Accesories, Kitchen table polyethylene, Polyethylene utility paddles, Polyethylene board stand.

Billots de boucher, Blocs sur comptoir, Polyéthylènes, Tables en bois, Tables en acier-inox, Accessoires, Poléthylène table-cuisine, Pelles polyéthylène, Supports table polyéthylène.

1 - 19

Todos nuestros productos fabricados están elaborados con madera de encina, previamente seleccionada y tratada con riguroso proceso de secado para sustraer la humedad, savia y glutinosa de la madera, dejando todas las betas limpias para que dicho producto no tenga impurezas en su interior.

Consiguiendo con este proceso que al manipular los alimentos no desprendan ningún tipo de impurezas. Para la conservación de la madera de nuestros productos fabricados, recomendamos usar nuestro rascador Ref. A-80 diariamente, para así conseguir mantener la superficie totalmente lisa y limpia.

No utilizando productos químicos que dañarian la conservación de nuestros pilones, tajos, tacos y mesas de madera. Todos los productos están autorizados por sanidad.

All our products are made with holm oak wood, previously selected and treated with a rigorous drying process to remove moisture, sap and glutinous wood, leaving all streaks clean in order to get a product with no impurities.

With this process, the food can be manipulated without any kind of impurities.

In order to get a better wood preservation of our products, we recommend using our scraper, Ref A-80, daily to keep it completely smooth and clean.

Do not use chemical products that could damage the conservation of our chopping blocks and wooden tables.

All products used are legally approved.

Tous nos produits sont fabriqués en bois de chêne vert, préalablement sélectionnés et traité avec un processus rigoureux séchage pour enlever l'humidité, le sève et le gluant du bois, en laissant tout le bois propre pour ce produit ne contienne pas d'impuretés en elle. Grâce à ce processus, lorsque vous manipulez des aliments aucune substance ne sera en dommagée.

Pour protéger le bois de nos produits, nous vous recommandons d'utiliser notre décapeuse Réf A-80 tous les jours, pour garder la surface lisse et propre. Utiliser de produits chimiques pourrait nuire à la conservation des pieds, des billots et des tables en bois.

Tous nos produits sont approuvés par le Ministère de la santé.



Madera de encina /
Holm oak wood /
Chêne vert



Ref.	Medidas Size Dimensions	Euros
EC-10	38 x 9 x 38 cm	105,00

Portacuchillos protegido, acero-inox
Con tres ranuras para cuchillos y chaira ovalada-redonda

Encased knife holder, stainless steel
Three grooves for knives and oval professional sharpener

Porte couteaux et fusil ovale rond, acier inox
Avec trois rainures pour couteaux et fusil ovale rond



Rascador
Para limpieza de pilones y tajos
de madera M

Grater
Inyectado chopping blocks

Grattoir
Pour billots

Ref.	Euros
A-80	17,00



Cepillo limpieza tablas
polietileno

Polyethylene cutting board
brush

Brosse nettoyage planches
poléthylène

Ref.	Euros
A-81	45,00

Recambio cuchilla A-81

Spare blade A-81

Lame de rechange A-81

Ref.	Euros
A-81-1	13,00



Portacuchillo de madrea

Wooden knife holder

Porte-couteaux en bois

Ref.	Euros
V-PORMAD	10,00

Portacuchillo de polietileno

Polyethylene knife holder

Porte-couteaux en polyéthène

Ref.	Color Colour Couleur	Euros
V-PORPOLB	○	20,00
V-PORPOLR	●	20,00

Portacuchillo de varilla acero-inox para tajo

Stainless steel Knife holder for block

Porte-couteaux en inox pour billot

Ref.	Tipo Type Type	Euros
V-PORACE-40	40	47,00
V-PORACE-44	44	50,00
V-PORACE-50	50	53,00

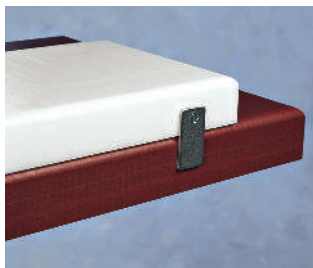

Tope valdilla acero inox

Stainless steel buffer

Bout acier inox

Ref.	Euros
V-VALDILLA	3,00

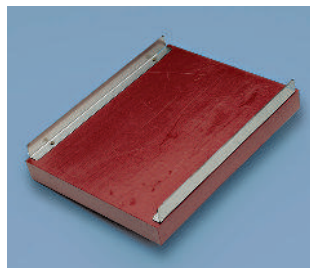

Guía tope vitrina inox

Stainless steel guides

Guides acier inox

Ref.	Medidas Size Dimensions	Euros
V-GUIA-40	40 x 3 x 2 cm	4,50

Pie regulable para pata inox

Adjustable foot for stainless steel legs

Pieds réglables pour inox pattes

Ref.	Euros
V-PR	2,50

Goma antideslizante

Stopper antiskid

Gomme antidérapante

Ref.	Euros
V-GOMA	0,30

Pie fijo para patas inox

Fixed foot for stainless legs

Pieds fixes pour inox pattes

Ref.	Euros
V-PF	0,75

TAJOS DE 4 PATAS CON TACO MADERA | CHOPPING BLOCKS WITH 4 LEGS | BILLOTS AVEC 4 PIEDS



**A - Tajo de 4 patas madera
Sin portacuchillos. Altura total 90 cms.**

A - 4-leg wooden chopping block table
Without knife holder. Total height 90 cm.

*A - Billot de boucher 4 pattes bois
Sans porte couteaux. Hauteur totale 90 cm.*

Ref.	Medida tajo Cutting board size Mesure bloc	Euros	Ref.	Medida tajo Cutting board size Mesure bloc	Euros	Ref.	Medida tajo Cutting board size Mesure bloc	Euros
V-A604025E	60 x 40 x 25 cm	578,00	V-A353525E	35 x 35 x 25 cm	345,00	V-A404015E	40 x 40 x 15 cm	322,00
V-A644425E	64 x 44 x 25 cm	655,00	V-A404025E	40 x 40 x 25 cm	411,00	V-A443215E	44 x 32 x 15 cm	307,00
V-A705025E	70 x 50 x 25 cm	778,00	V-A444425E	44 x 44 x 25 cm	480,00	V-A604015E	60 x 40 x 15 cm	424,00
V-A804025E	80 x 40 x 25 cm	727,00	V-A505025E	50 x 50 x 25 cm	586,00	V-A806015E	80 x 60 x 15 cm	723,00
V-A884425E	88 x 44 x 25 cm	852,00	V-A606015E	60 x 60 x 15 cm	567,00	V-A1006015E	100 x 60 x 15 cm	871,00
V-A1005025E	100 x 50 x 25 cm	1074,00				V-A1206015E	120 x 60 x 15 cm	1043,00



I - Tajo de 4 Pata de acero inox con faldón Sin portacuchillos. Altura total 90cms.

I - Chopping block with 4 stainless steel legs with drawer
Whithout knifeholder. Total height 90 cm.

*I - Billots avec 4 pieds en inox avec jupe
Sans porte couteaux. Hauteur totale 90 cm.*

Ref.	Medida taco Cutting board size Mesure bloc	Euros
V-I404025E	40 x 40 x 25 cm	548,00
V-I444425E	44 x 44 x 25 cm	618,00
V-I505025E	50 x 50 x 25 cm	731,00
V-I604025E	60 x 40 x 25 cm	722,00

Ref.	Medida taco Cutting board size Mesure bloc	Euros
V-I644425E	64 x 44 x 25 cm	813,00
V-I705025E	70 x 50 x 25 cm	938,00
V-I804025E	80 x 40 x 25 cm	923,00
V-I884425E	88 x 44 x 25 cm	1095,00
V-I1005025E	100 x 50 x 25 cm	1332,00



I-2 - Tajo de 4 patas de acero-inox sin faldón Sin portacuchillos. Altura total 90 cms.

I-2 - Chopping block with 4 stainless legs without drawer
Without knife holder. Total height 90 cm.

*I-2 - Billots avec 4 pieds en inox sans jupe
Sans porte couteaux. Hauteur totale 90 cm.*

Ref.	Medida taco Cutting board size Mesure bloc	Euros
V-I2404025E	40 x 40 x 25 cm	538,00
V-I2444425E	44 x 44 x 25 cm	605,00
V-I2505025E	50 x 50 x 25 cm	711,00
V-I2604025E	60 x 40 x 25 cm	704,00

Ref.	Medida taco Cutting board size Mesure bloc	Euros
V-I2644425E	64 x 44 x 25 cm	789,00
V-I2705025E	70 x 50 x 25 cm	910,00
V-I2804025E	80 x 40 x 25 cm	858,00
V-I2884425E	88 x 44 x 25 cm	998,00
V-I21005025E	100 x 50 x 25 cm	1222,00



S - Tajo de 4 patas insonorizado de acero-inox Sin portacuchillo. Altura total 90 cms.

S - 4-legs stainless steel sound proof anti-vibration chopping block table
Without knife holder. Total height 90 cm.

*S - Billot avec 4 pieds acier inox insonorisé
antivibratoire.
Sans porte couteaux. Hauteur totale 90 cm.*

Ref.	Medida taco Cutting board size Mesure bloc	Euros
V-S443225E	44 x 32 x 25 cm	1105,00
V-S444425E	44 x 44 x 25 cm	1226,00
V-S604025E	60 x 40 x 25 cm	1380,00
V-S705025E	70 x 50 x 25 cm	1607,00



J - Tajo de 3 patas de madera
Altura total 90 cms.

J - Chopping blocks with 3 wooden legs
 Total height 90 cm.

J - Billots avec 3 pieds en bois
 Hauteur totale 90 cm.

Ref.	Medida taco Cutting board size Mesure bloc	Euros
V-J3225E	Ø 32 x 25 cm	305,00
V-J3525E	Ø 35 x 25 cm	348,00
V-J3825E	Ø 38 x 25 cm	392,00
V-J4425E	Ø 44 x 25 cm	466,00

TACOS DE MADERA | CHOPPING BLOCKS | BILLOTS



O - Tacos de madera cuadrados

O - Square cutting boards

O - Blocs carrés

Ref.	Medidas Size Dimensions	Euros	Ref.	Medidas Size Dimensions	Euros
V-O323210E	32 x 32 x 10 cm	87,00	V-O383815E	38 x 38 x 15 cm	166,00
V-O323215E	32 x 32 x 15 cm	119,00	V-O383820E	38 x 38 x 20 cm	213,00
V-O323220E	32 x 32 x 20 cm	152,00	V-O383825E	38 x 38 x 25 cm	262,00
V-O323225E	32 x 32 x 25 cm	188,00	V-O404015E	40 x 40 x 15 cm	185,00
V-O353510E	35 x 35 x 10 cm	105,00	V-O404020E	40 x 40 x 20 cm	237,00
V-O353515E	35 x 35 x 15 cm	142,00	V-O404025E	40 x 40 x 25 cm	291,00
V-O353520E	35 x 35 x 20 cm	182,00	V-O444410E	44 x 44 x 10 cm	162,00
V-O353525E	35 x 35 x 25 cm	224,00	V-O444415E	44 x 44 x 15 cm	224,00
V-O383810E	38 x 38 x 10 cm	121,00	V-O444420E	44 x 44 x 20 cm	286,00
			V-O444425E	44 x 44 x 25 cm	352,00
			V-O505025E	50 x 50 x 25 cm	453,00
			V-O606015E	60 x 60 x 15 cm	416,00



O - Tacos de madera redondos

O - Round cutting boards

O - Blocs ronds

Ref.	Diámetro Diameter Diamètre	Altura Height Hauteur	Euros
V-O3210E	Ø 32 cm	10 cm	91,00
V-O3215E	Ø 32 cm	15 cm	125,00
V-O3220E	Ø 32 cm	20 cm	162,00
V-O3225E	Ø 32 cm	25 cm	196,00
V-O3510E	Ø 35 cm	10 cm	108,00
V-O3515E	Ø 35 cm	15 cm	149,00
V-O3520E	Ø 35 cm	20 cm	190,00
V-O3525E	Ø 35 cm	25 cm	233,00
V-O3810E	Ø 38 cm	10 cm	125,00

Ref.	Diámetro Diameter Diamètre	Altura Height Hauteur	Euros
V-O3815E	Ø 38 cm	15 cm	175,00
V-O3820E	Ø 38 cm	20 cm	224,00
V-O3825E	Ø 38 cm	25 cm	277,00
V-O4025E	Ø 40 cm	25 cm	305,00
V-O4410E	Ø 44 cm	10 cm	169,00
V-O4415E	Ø 44 cm	15 cm	235,00
V-O4420E	Ø 44 cm	20 cm	298,00
V-O4425E	Ø 44 cm	25 cm	358,00



G - Tacos de madera rectangulares

G - Rectangular cutting boards

G - Blocs rectangulaires

Ref.	Medidas Size Dimensions	Euros
V-G37245E	37 x 24 x 5 cm	50,00
V-G372410E	37 x 24 x 10 cm	76,00
V-G372415E	37 x 24 x 15 cm	105,00
V-G442610E	44 x 26 x 10 cm	96,00
V-G442615E	44 x 26 x 15 cm	132,00
V-G442620E	44 x 26 x 20 cm	169,00
V-G443210E	44 x 32 x 10 cm	119,00
V-G443215E	44 x 32 x 15 cm	163,00
V-G443220E	44 x 32 x 20 cm	208,00
V-G443225E	44 x 32 x 25 cm	256,00

Ref.	Medidas Size Dimensions	Euros
V-G604025E	60 x 40 x 25 cm	445,00
V-G643215E	64 x 32 x 15 cm	248,00
V-G644415E	64 x 44 x 15 cm	335,00
V-G644420E	64 x 44 x 20 cm	424,00
V-G644425E	64 x 44 x 25 cm	520,00
V-G705025E	70 x 50 x 25 cm	642,00
V-G804025E	80 x 40 x 25 cm	591,00
V-G883215E	88 x 32 x 15 cm	335,00
V-G884425E	88 x 44 x 25 cm	711,00
V-G1005025E	100 x 50 x 25 cm	921,00
V-G604015E	60 x 40 x 15 cm	278,00
V-G806015E	80 x 60 x 15 cm	555,00
V-G1006015E	100 x 60 x 15 cm	693,00
V-G1206015E	120 x 60 x 15 cm	832,00



Tabla de corte en madera

Wooden cutting board

Planche à découper en bois

Ref.	Medidas Size Dimensions	Euros
V-T50325	50 x 32 x 5 cm	91,00
V-T50355	50 x 35 x 5 cm	99,00
V-T50405	50 x 40 x 5 cm	114,00



B - Pilón graduable descentrado epoxi
 Altura pie mínima 65 máxima 110 cm. Modelo ideal para espacios reducidos, trabajando la parte superior por encima del mostrador, evitando perjudicar con el golpe la vitrina. Al mismo tiempo aprovechamos la anchura del pasillo. Graduación a la altura de corte desea. Colocación: 4 tornillos al suelo. Se puede montar con tacos cuadrados ó polietileno.

B - Adjustable decentred epoxy leg
 Minimum leg height 65, maximum 110 cm. An ideal model for cramped spaces, enables you to work on top of the counter thus avoiding any damage to glass display. It also gives you more room behind the counter. Adjustable to the desired chopping height. Placing: 4 screws on the floor. Can be assembled with square blocks or polyethylene.

B - Pied réglable décentré époxy
 Hauteur pied minimum 65, maximum 110 cm. Modèle idéal pour les espaces réduits, pour travailler sur la partie supérieure du comptoir en évitant de porter un coup à la vitrine. Nous profitons du même coup de la largeur du couloir. Réglable à l'hauteur de coupe désirée. Lieu: 4 vis sur le sol. Il peut être monté avec billots carrés.

Ref.	Euros
V-BPGD	289,00



B - Pilón graduable descentrado acero-inox
 Altura pie mínima 80, máxima 105 cm. Modelo ideal para espacios reducidos, trabajando la parte superior por encima del mostrador, evitando perjudicar con el golpe la vitrina. Al mismo tiempo aprovechamos la anchura del pasillo. Graduación a la altura de corte deseada. Colocación: 4 tornillos al suelo. Se puede montar con tacos cuadrados o redondos.

B - Adjustable decentred stainless steel leg
 Minimum leg height 80, maximum 105 cm. An ideal model for cramped spaces, enables you to work on top of the counter thus avoiding any damage to glass display. It also gives you more room behind the counter. Adjustable to the desired chopping height. Placing: 4 screws on the floor. Can be assembled with square or round blocks.

B - Pied réglable décentré acier inox
 Hauteur pied minimum 80, maximum 105 cm. Modèle idéal pour les espaces réduits, pour travailler sur partie supérieure du comptoir en évitant de porter un coup à la vitrine. Nous profitons du même coup de la largeur du couloir. Réglable à l'hauteur de coupe désirée. Lieu: 4 vis sur le sol. Il peut être monté avec billots carrés ou ronds.

Ref.	Euros
V-BPGDI	650,00



E - Trípode metálico epoxi
 Altura 70 cm. Se puede montar con tacos cuadrados, redondos ó polietileno.

E - Metallic epoxy tripod
 Total height 70 cm. It can be mounted with square, round or polyethylene cutting boards.

E - Trépied métallique époxy
 Hauteur 70 cm. Peut être monté avec des taquets carrés, rectangulaires ou polyéthylène.

Ref.	Euros
V-ETM	200,00



E - Trípode acero-inox
 Altura 70 cm. Se puede montar con tacos cuadrados, redondos ó polietileno

E - Stainless steel tripod
 Height 70 cm. It can be mounted with square, round or polyethylene cutting boards.

E - Trépied acier inox
 Hauteur 70 cm. Peut être monté avec des taquets carrés, rectangulaires ou polyéthylène

Ref.	Euros
V-ETI	385,00

**H - Tablas de polietileno
Grosor 1,5 cm**

H - Polyethylene boards
Thickness 1.5 cm

H - Plaques en polyéthylène
Épaisseur 1,5 cm

Ref.	Medidas Size Dimensions	Euros
V-H25191.5	25 x 19	5,95
N V-H30201.5	30 x 20	7,00
V-H33191.5	33 x 19	7,75
V-H33331.5	33 x 33	12,80
N V-H40201.5	40 x 20	9,40
V-H40251.5	40 x 25	11,70
V-H40301.5	40 x 30	14,00
V-H40331.5	40 x 33	15,45
V-H40401.5	40 x 40	18,75
V-H50251.5	50 x 25	14,60
V-H50301.5	50 x 30	17,55
V-H50331.5	50 x 33	19,35
V-H50401.5	50 x 40	23,40
V-H50501.5	50 x 50	29,20
V-H60251.5	60 x 25	17,55
V-H60301.5	60 x 30	21,05
V-H60331.5	60 x 33	23,20
V-H60401.5	60 x 40	28,00
V-H75251.5	75 x 25	21,90
V-H75331.5	75 x 33	29,00
V-H100251.5	100 x 25	29,20
V-H100331.5	100 x 33	38,60
V-H150251.5	150 x 25	43,80
V-H150331.5	150 x 33	57,95
V-H200251.5	200 x 25	58,40
V-H200331.5	200 x 33	77,25
V-H2001001.5	200 x 100	230,00

**H - Tablas de polietileno
Grosor 2 cm**

H - Polyethylene boards
Thickness 2 cm

H - Plaques en polyéthylène
Épaisseur 2 cm

Ref.	Medidas Size Dimensions	Euros
V-H25192	30 x 20	7,75
N V-H30202	30 x 20	9,15
V-H33192	33 x 19	10,10
V-H33332	33 x 33	16,65
N V-H40202	40 x 20	12,20
V-H40252	40 x 25	15,25
V-H40302	40 x 30	18,30
V-H40332	40 x 33	20,20
V-H40402	40 x 40	24,40
V-H50252	50 x 25	19,05
V-H50302	50 x 30	22,90
V-H50332	50 x 33	25,25
V-H50402	50 x 40	30,50
V-H50502	50 x 50	38,05
V-H60252	60 x 25	22,90
V-H60302	60 x 30	27,50
V-H60332	60 x 33	30,30
V-H60402	60 x 40	36,55
V-H75252	75 x 25	28,55
V-H75332	75 x 33	37,85
V-H100252	100 x 25	38,10
V-H100332	100 x 33	50,50
V-H150252	150 x 25	57,10
V-H150332	150 x 33	75,65
V-H200252	200 x 25	76,15
V-H200332	200x 33	100,85
V-H2001002	200 x 100	300,08

**H - Tablas de polietileno
Grosor 3 cm**

H - Polyethylene boards
Thickness 3 cm

H - Plaques en polyéthylène
Épaisseur 3 cm

Ref.	Medidas Size Dimensions	Euros
V-H25193	25 x 19	11,60
N V-H30203	30 x 20	13,75
V-H33193	33 x 19	15,10
V-H33333	33 x 33	24,95
N V-H40203	40 x 20	18,30
V-H40253	40 x 25	22,90
V-H40303	40 x 30	27,45
V-H40333	40 x 33	30,20
V-H40403	40 x 40	36,55
V-H50253	50 x 25	28,55
V-H50303	50 x 30	34,30
V-H50333	50 x 33	37,75
V-H50403	50 x 40	45,70
V-H50603	50 x 50	57,05
V-H60253	60 x 25	34,30
V-H60303	60 x 30	41,20
V-H60333	60 x 33	45,30
V-H60403	60 x 40	54,80
V-H75253	75 x 25	42,85
V-H75333	75 x 33	56,65
V-H100253	100 x 25	57,10
V-H100333	100 x 33	75,45
V-H150253	150 x 25	85,65
V-H150333	150 x 33	113,20
V-H200253	200 x 25	114,20
V-H200333	200 x 33	150,90
V-H2001003	200 x 100	450,00



MN= Marmóreo N/B / Marmorean / Marmoréen
M= Marmóreo R/B / Marmorean / Marmoréen
B= Blanco / White / Blanc

A= Amarillo / Yellow / Jaune
S= Salmón / Salmon / Saumon
R= Rojo / Red / Rouge

V= Verde / Green / Vert
AZ= Azul / Blue / Bleu
N= Negro / Black / Noir

RV= Rojo Vivo / Light Red / Rouge Vivant

H - Tablas de polietileno Grosor 4 cm

H - Polyethylene boards
Thickness 4 cm

H - Plaques en polyéthylène
Épaisseur 4 cm

Ref.	Medidas Size Dimensions	Euros
V-H25194	25 x 19	15,45
N V-H30204	30 x 20	18,30
V-H33194	33 x 19	20,15
V-H33334	33 x 33	33,20
N V-H40204	40 x 20	24,40
V-H40254	40 x 25	30,50
V-H40304	40 x 30	36,55
V-H40334	40 x 33	40,25
V-H40404	40 x 40	48,75
V-H50254	50 x 25	38,10
V-H50304	50 x 30	45,70
V-H50334	50 x 33	50,30
V-H50404	50 x 40	60,90
V-h50504	50 x 50	76,10
V-H60254	60 x 25	45,70
V-H60304	60 x 30	54,85
V-H60334	60 x 33	60,35
V-H60404	60 x 40	73,05
V-H75254	75 x 25	57,10
V-H75334	75 x 33	75,45
V-H100254	100 x 25	76,15
V-H100334	100 x 33	100,60
V-H150254	150 x 25	114,20
V-H150334	150 x 33	150,90
V-H200254	200 x 25	152,30
V-H200334	200 x 33	201,15
V-H2001004	200 x 100	599,00

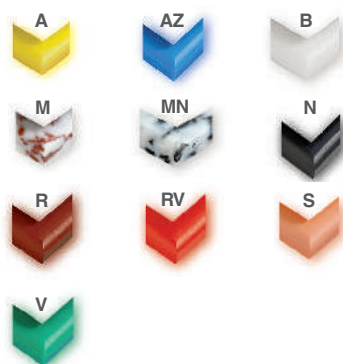

Tablas de polietileno Grosor 5 cm

Polyethylene boards
Thickness 5 cm

Plaques en polyéthylène
Épaisseur 5 cm

Ref.	Medidas Size Dimensions	Euros
V-H25195	25 x 19	19,15
N V-H30205	30 x 20	22,85
V-H33195	33 x 19	25,15
V-H33335	33 x 33	41,55
N V-H40205	40 x 20	30,50
V-H40255	40 x 25	38,10
V40305	40 x 30	45,70
V-H40335	40 x 33	50,30
V-H40405	40 x 40	60,95
V-H45455	45 x 45	77,90
V-H50255	50 x 25	47,60
V-H50305	50 x 30	57,20
V-H50335	50 x 33	62,90
V-H50405	50 x 40	76,15
V-H50505	50 x 50	95,15
V-H60255	60 x 25	57,10
V-H60305	60 x 30	68,60
V-H60335	60 x 33	75,45
V-H60405	60 x 40	91,35
V-H65455	65 x 45	116,80
V-H70505	70 x 50	137,30
V-H75255	75 x 25	71,40
V-H75335	75 x 33	94,30
V-H80405	80 x 40	121,90
V-H90455	90 x 45	164,40
V-H100255	100 x 25	95,20
V-H100335	100 x 33	125,75
V-H100505	100 x 50	190,25
V-H150255	150 x 25	142,75
V-H150335	150 x 33	188,65
V-H200255	200 x 25	190,35
V-H200335	200 x 33	251,45
V-H2001005	200 x 100	747,00

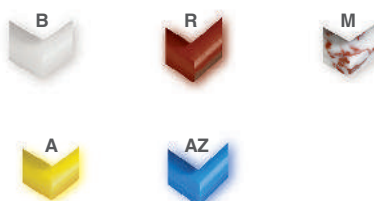

LAS TABLAS REDONDAS Y LAS TABLAS PARA ACOPLAR SE INCREMENTARÁN 15,00 euros. / ROUNDS BOARDS AND BOARDS FOR FITTING INCREASE PRICE IN 15,00 euros. / PLAQUES RONDES ET PLAQUES POUR AJUSTER AUGMENTENT PRIX EN 15,00 euros.

	PRECIO CORTE CM ² EUROS / CUTTING PRICE / PRIX DECOUPE	COLORES / COLOURS / COULEURS
N 0,3 CM ²	0,0045	B
N 1CM ²	0,0098	B
1,5 CM ²	0,0134	B-R-M
2 CM ²	0,0175	B-R-M-A-AZ-S-V-N-RV-MN
3 CM ²	0,0258	B-R-M
4 CM ²	0,0350	B-R-M-A-AZ-S-V-N-RV-MN
5 CM ²	0,0433	B-R-M-A-AZ
9 CM ²	0,0900	B-R
14 CM ²	0,1800	B-R

LARGO x ANCHO x EUROS CM². EJEMPLO: TABLA MEDIDA 55x28x3. PRECIO: 55 x 28 x 0,0258 = 39,73 euros. LENGHT x WIDTH x EUROS CM². EIXAMPLE: BOARD SIZE 55x28x3. PRICE: 55 x 28 x 0,0258 = 39,73 euros. LONG x LARGE x EUROS CM². EXEMPLE: PLAQUE DIMENSION 55x28x3. PRIX: 55 x 28 x 0,0258 = 39,73 euros.

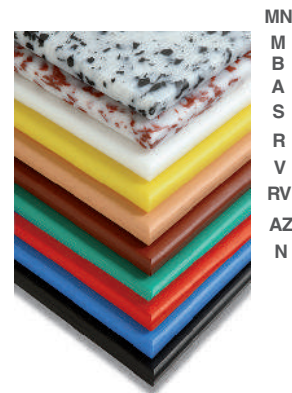

MN
M
B
A
S
R
V
RV
AZ
N



**Tablas de polietileno
En Blanco (Ref + B) y Rojo (Ref + R)**

Polyethylene boards
In White (Ref. + B) and Red (Ref. + R)

Plaques en poléthylène
Couleurs Blanc (Réf. + B) et Rouge (Réf. + R)

Ref.	Medidas Size Dimensions	Euros
V-H40339	40 x 33 x 9 cm	105,00
V-H40409	40 x 40 x 9 cm	129,00
V-H45459	45 x 45 x 9 cm	171,00
V-H50339	50 x 33 x 9 cm	132,00
V-H50509	50 x 50 x 9 cm	198,00
V-H60409	60 x 40 x 9 cm	191,00
V-H403314	40 x 33 x 14 cm	214,00
V-H503314	50 x 33 x 14 cm	267,00

**F - Taco madera fabricado en cuadradillo
y 5 cm polietileno rectangulares
En Blanco (Ref + B) y Rojo (Ref + R)**

F - Wooden block and 5 cm rectangular
polyethylene board
In White (Ref. + B) and Red (Ref. + R)

F - Bloc en bois et plaque en polyéthylène
rectangulaire
Couleurs Blanc (Réf. + B) et Rouge (Réf. + R)

Ref.	Medida taco Cutting board size Mesure bloc	Euros
V-F403315PL	40 x 33 x 15 cm	132,00
V-F403320PL	40 x 33 x 20 cm	167,00
V-F403325PL	40 x 33 x 25 cm	198,00
V-F503315PL	50 x 33 x 15 cm	164,00
V-F503320PL	50 x 33 x 20 cm	209,00
V-F503325PL	50 x 33 x 25 cm	247,00
V-F604020PL	60 x 40 x 20 cm	302,00
V-F604025PL	60 x 40 x 25 cm	358,00
V-F644520PL	64 x 45 x 20 cm	371,00
V-F644525PL	64 x 45 x 25 cm	429,00
V-F705020PL	70 x 50 x 20 cm	444,00
V-F705025PL	70 x 50 x 25 cm	524,00
V-F804020PL	80 x 40 x 20 cm	403,00
V-F804025PL	80 x 40 x 25 cm	476,00
V-F904520PL	90 x 45 x 20 cm	520,00

**Tablas redondo de polietileno
En Blanco (Ref + B) y Rojo (Ref + R)**

Round polyethylene boards
In White (Ref. + B) and Red (Ref. + R)

Plaque ronds en poléthylène
Couleurs Blanc (Réf. + B) et Rouge (Réf. + R)

Ref.	Diámetro Diameter Diamètre	Altura Height Hauteur	Euros
V-H355	Ø 35 cm	5 cm	64,00
V-H359	Ø 35 cm	9 cm	121,00
V-H3514	Ø 35 cm	14 cm	237,00
V-H405	Ø 40 cm	5 cm	80,00
V-H409	Ø 40 cm	9 cm	139,00
V-H4014	Ø 40 cm	14 cm	279,00

**F - Taco madera fabricado en cuadradillo
y 5 cm polietileno cuadrados
En Blanco (Ref + B) y Rojo (Ref + R)**

F - Wooden block and 5 cm square
polyethylene board
In White (Ref. + B) and Red (Ref. + R)

F - Bloc en bois et plaque en polyéthylène
carrée
Couleurs Blanc (Réf. + B) et Rouge (Réf. + R)

Ref.	Medida taco Cutting board size Mesure bloc	Euros
V-F333315PL	33 x 33 x 15 cm	109,00
V-F333320PL	33 x 33 x 20 cm	139,00
V-F333325PL	33 x 33 x 25 cm	163,00
V-F353515PL	35 x 35 x 15 cm	128,00
V-F353520PL	35 x 35 x 20 cm	162,00
V-F353525PL	35 x 35 x 25 cm	189,00
V-F404020PL	40 x 40 x 20 cm	202,00
V-F404025PL	40 x 40 x 25 cm	238,00
V-F454520PL	45 x 45 x 20 cm	249,00
V-F454525PL	45 x 45 x 25 cm	293,00
V-F505020PL	50 x 50 x 20 cm	316,00
V-F505025PL	50 x 50 x 25 cm	372,00

Agujero Ø 12 cm para tabla

Ø 12 cm hole for table

Trou Ø 12 cm pour table

Ref.	Altura Height Hauteur	Euros
V-HAGU5	5 cm	32,00
V-HAGU9	9 cm	42,00
V-HAGU14	14 cm	58,00



**F - Taco madera fabricado en cuadradillo
y 5 cm polietileno cilíndricos
En Blanco (Ref + B) y Rojo (Ref + R)**

F - Wooden block and 5 cm cylindrical
polyethylene board
In White (Ref. + B) and Red (Ref. + R)

F - Bloc en bois et plaque en polyéthylène
cylindrique
Couleurs Blanc (Réf. + B) et Rouge (Réf. + R)

Ref.	Medida taco Cutting board size Mesure bloc	Euros
V-F3315PL	Ø 33 x 15 cm	120,00
V-F3320PL	Ø 33 x 20 cm	152,00
V-F3325PL	Ø 33 x 25 cm	180,00
V-F3515PL	Ø 35 x 15 cm	142,00
V-F3520PL	Ø 35 x 20 cm	179,00
V-F3525PL	Ø 35 x 25 cm	209,00
V-F4020PL	Ø 40 x 20 cm	223,00
V-F4025PL	Ø 40 x 25 cm	263,00
V-F4520PL	Ø 45 x 20 cm	273,00
V-F4525PL	Ø 45 x 25 cm	322,00



F - Tajo de 4 patas de madera (Ref. A) con taco de madera fabricado en cuadradillo + 5 cm polietileno
Sin portacuchillos. Altura total 85 cm. En Blanco (Ref + B) y Rojo (Ref + R)

F - 4 wooden legs chopping block table (Ref. A) + 5 cm polyethylene board. Without knife holder. Total height 85 cm. In White (Ref. + B) and Red (Ref. + R)

F - Billot de 4 pieds en bois (Réf. A) + plaque en polyéthylène de 5 cm
Sans porte couteaux. Hauteur totale 85 cm. Couleurs Blanc (Réf. + B) et Rouge (Réf. + R)

Ref.	Medida taco Cutting board size Mesure bloc	Euros
V-FA404020PL	40 x 40 x 20 cm	323,00
V-FA454520PL	45 x 45 x 20 cm	377,00
V-FA505020PL	50 x 50 x 20 cm	449,00
V-FA604020PL	60 x 40 x 20 cm	436,00
V-FA644520PL	64 x 45 x 20 cm	505,00
V-FA705020PL	70 x 50 x 20 cm	580,00
V-FA804020PL	80 x 40 x 20 cm	539,00
V-FA904520PL	90 x 45 x 20 cm	661,00
V-FA1005020PL	100 x 50 x 20 cm	782,00



F - Tajo de 4 patas de acero-inox con faldón (Ref. I) con taco de madera fabricado en cuadradillo + 5 cm polietileno
Sin portacuchillos. Altura total 85 cm. En Blanco (Ref + B) y Rojo (Ref + R)

F - 4 stainless steel legs chopping block table with drawer (Ref. I) + 5 cm polyethylene board. Without knife holder. Total height 85 cm. In White (Ref. + B) and Red (Ref. + R)

F - Billot de 4 pieds en inox avec jupe (Réf. I) + plaque en polyéthylène de 5 cm
Sans porte couteaux. Hauteur totale 85 cm. Couleurs Blanc (Réf. + B) et Rouge (Réf. + R)

Ref.	Medida taco Cutting board size Mesure bloc	Euros
V-FI404020PL	40 x 40 x 20 cm	461,00
V-FI454520PL	45 x 45 x 20 cm	518,00
V-FI505020PL	50 x 50 x 20 cm	595,00
V-FI604020PL	60 x 40 x 20 cm	581,00
V-FI644520PL	64 x 45 x 20 cm	665,00
V-FI705020PL	70 x 50 x 20 cm	742,00
V-FI804020PL	80 x 40 x 20 cm	738,00
V-FI904520PL	90 x 45 x 20 cm	906,00
V-FI1005020PL	100 x 50 x 20 cm	1043,00



F - Tajo de 4 patas de acero-inox sin faldón (Ref. I-2) con taco de madera fabricado en cuadradillo + 5 cm polietileno
Sin portacuchillos. Altura total 85 cm. En Blanco (Ref + B) y Rojo (Ref + R)

F - 4 stainless steel legs chopping block table without drawer (Ref. I-2) + 5 cm polyethylene board. Without knife holder. Total height 85 cm. In White (Ref. + B) and Red (Ref. + R)

F - Billot de 4 pieds en inox sans jupe (Réf. I-2) + plaque en polyéthylène de 5 cm
Sans porte couteaux. Hauteur totale 85 cm. Couleurs Blanc (Réf. + B) et Rouge (Réf. + R)

Ref.	Medida taco Cutting board size Mesure bloc	Euros
V-FI2404020PL	40 x 40 x 20 cm	451,00
V-FI2454520PL	45 x 45 x 20 cm	502,00
V-FI2505020PL	50 x 50 x 20 cm	575,00
V-FI2604020PL	60 x 40 x 20 cm	562,00
V-FI2644520PL	64 x 45 x 20 cm	638,00
V-FI2705020PL	70 x 50 x 20 cm	714,00
V-FI2804020PL	80 x 40 x 20 cm	674,00
V-FI2904520PL	90 x 45 x 20 cm	808,00
V-FI21005020PL	100 x 50 x 20 cm	933,00

0 1 TAJO DE 4 PATAS CON TACO MADERA Y SOBRE DE POLIETILENO | 4 LEGS WOODEN CHOPPING BLOCK WITH POLYETHYLENE BOARD | BILLOT EN BOIS DE 4 PIEDS AVEC PLAQUE EN POLYÉTHYLÈNE



F - Tajo de 4 patas insonorizado de acero-inox (Ref. S) con taco de madera fabricado en cuadradillo + 5 cm polietileno Sin portacuchillo. Altura total 85 cm. En Blanco (Ref + B) y Rojo (Ref + R)

F - 4-leg stainless steel sound proof anti-vibration chopping block table (Ref. S) + 5 cm polyethylene board Without knife holder. Total height 85 cm. In White (Ref. + B) and Red (Ref. + R)

F - Billot avec 4 pieds acier inox insonorisé antivibratoire (Réf. S) + plaque en polyéthylène de 5 cm Sans porte couteaux. Hauteur totale 85 cm. Couleurs Blanc (Réf. + B) et Rouge (Réf. + R)

Ref.	Medida taco Cutting board size Mesure bloc	Euros
V-FS453320PL	45 x 33 x 20 cm	1057,00
V-FS454520PL	45 x 45 x 20 cm	1124,00
V-FS604020PL	60 x 40 x 20 cm	1236,00
V-FS705020PL	70 x 50 x 20 cm	1410,00

MESAS DE CORTE | CUTTING TABLES | TABLES DÉCOUPE



L - Mesa de madera con faldón y sobre de polietileno Polietileno 5 cm, altura total 90 cm En Blanco (Ref + B) y Rojo (Ref + R)

L - Wooden table with drawer and polyethylene board Polyethylene 5 cm, total Height 90 cm. In White (Ref. + B) and Red (Ref. + R)

L - Table en bois de découpe avec jupe et plaque en polyéthylène Polyéthylène 5 cm, hauteur Totale 90 cm. Couleurs Blanc (Réf. + B) et Rouge (Réf. + R)

Ref.	Medidas Size Dimensions	Euros
V-L40405	40 x 40 cm	253,00
V-L45455	45 x 45 cm	279,00
V-L50505	50 x 50 cm	307,00
V-L60405	60 x 40 cm	303,00
V-L70505	70 x 50 cm	367,00

Mesa de madera con faldón y sobre de polietileno Polietileno 9 cm, altura total 94 cm En Blanco (Ref + B) y Rojo (Ref + R)

Wooden table with drawer and polyethylene board Polyethylene 9 cm, total Height 94 cm. In White (Ref. + B) and Red (Ref. + R)

Table en bois de découpe avec jupe et plaque en polyéthylène Polyéthylène 9 cm, hauteur Totale 94 cm. Couleurs Blanc (Réf. + B) et Rouge (Réf. + R)

Ref.	Medidas Size Dimensions	Euros
V-L40409	40 x 40 cm	323,00
V-L45459	45 x 45 cm	376,00
V-L50509	50 x 50 cm	416,00
V-L60409	60 x 40 cm	407,00
V-L70509	70 x 50 cm	556,00



L-2 - Mesa de madera sin faldón y sobre de polietileno Polietileno 5 cm, altura total 90 cm En Blanco (Ref + B) y Rojo (Ref + R)

L-2 - Wooden table without drawer and polyethylene board Polyethylene 5 cm, total Height 90 cm. In White (Ref. + B) and Red (Ref. + R)

L-2 - Table en bois de découpe sans jupe et plaque en polyéthylène Polyéthylène 5 cm, hauteur Totale 90 cm. Couleurs Blanc (Réf. + B) et Rouge (Réf. + R)

Ref.	Medidas Size Dimensions	Euros
V-L240405	40 x 40 cm	197,00
V-L245455	45 x 45 cm	221,00
V-L250505	50 x 50 cm	243,00
V-L260405	60 x 40 cm	238,00
V-L270505	70 x 50 cm	287,00

Mesa de madera sin faldón y sobre de polietileno Polietileno 9 cm, altura total 94 cm En Blanco (Ref + B) y Rojo (Ref + R)

Wooden table without drawer and polyethylene board Polyethylene 9 cm, total Height 94 cm. In White (Ref. + B) and Red (Ref. + R)

Table en bois de découpe sans jupe et plaque en polyéthylène Polyéthylène 9 cm, hauteur Totale 94 cm. Couleurs Blanc (Réf. + B) et Rouge (Réf. + R)

Ref.	Medidas Size Dimensions	Euros
V-L240409	40 x 40 cm	267,00
V-245459	45 x 45 cm	318,00
V-L250509	50 x 50 cm	351,00
V-L260409	60 x 40 cm	342,00
V-L270509	70 x 50 cm	474,00



K - Mesa de acero-inox con faldón y estante sobre de polietileno
Polietileno 5 cm, altura total 90 cm
En Blanco (Ref + B) y Rojo (Ref + R)

K - Stainless steel table with drawer and shelf + polyethylene
 Polyethylene 5 cm, total height 90 cm.
 In White (Ref. + B) and Red (Ref. + R)

K - Table d'inox avec jupe et étagère + polyéthylène
Polyéthylène 5 cm, hauteur totale 90 cm.
Couleurs Blanc (Réf. + B) et Rouge (Réf. + R)

Ref.	Medidas Size Dimensions	Euros
V-K40405	40 x 40 cm	322,00
V-K45455	45 x 45 cm	348,00
V-K50505	50 x 50 cm	374,00
V-K60405	60 x 40 cm	371,00
V-K70505	70 x 50 cm	435,00

Mesa de acero-inox con faldón y estante sobre de polietileno
Polietileno 9 cm, altura total 94 cm
En Blanco (Ref + B) y Rojo (Ref + R)

Stainless steel table with drawer and shelf + polyethylene
 Polyethylene 9 cm, total Height 94 cm.
 In White (Ref. + B) and Red (Ref. + R)

Table d'inox avec jupe et étagère + polyéthylène
Polyéthylène 9 cm, hauteur Totale 94 cm.
Couleurs Blanc (Réf. + B) et Rouge (Réf. + R)

Ref.	Medidas Size Dimensions	Euros
V-K40409	40 x 40 cm	392,00
V-K45459	45 x 45 cm	443,00
V-K50509	50 x 50 cm	480,00
V-K60409	60 x 40 cm	473,00
V-K70509	70 x 50 cm	617,00



K-5 - Mesa de acero-inox pesada con faldón y estante sobre de polietileno
Polietileno 5 cm, altura total 90 cm
En Blanco (Ref + B) y Rojo (Ref + R)

K-5 - Stainless steel heavy table with drawer and shelf + polyethylene
 Polyethylene 5 cm, total height 90 cm.
 In White (Ref. + B) and Red (Ref. + R)

K-5 - Table lourd d'inox avec jupe et étagère + polyéthylène
Polyéthylène 5 cm, hauteur totale 90 cm.
Couleurs Blanc (Réf. + B) et Rouge (Réf. + R)

Ref.	Medidas Size Dimensions	Euros
V-K540405	40 x 40 cm	411,00
V-K545455	45 x 45 cm	449,00
V-K550505	50 x 50 cm	485,00
V-K560405	60 x 40 cm	482,00
V-K570505	70 x 50 cm	568,00

Mesa de acero-inox pesada con faldón y estante sobre de polietileno
Polietileno 9 cm, altura total 94 cm
En Blanco (Ref + B) y Rojo (Ref + R)

Stainless steel heavy table with drawer and shelf + polyethylene
 Polyethylene 9 cm, total Height 94 cm.
 In White (Ref. + B) and Red (Ref. + R)

Table lourd d'inox avec jupe et étagère + polyéthylène
Polyéthylène 9 cm, hauteur Totale 94 cm.
Couleurs Blanc (Réf. + B) et Rouge (Réf. + R)

Ref.	Medidas Size Dimensions	Euros
V-K540409	40 x 40 cm	481,00
V-K545459	45 x 45 cm	544,00
V-K550509	50 x 50 cm	592,00
V-K560409	60 x 40 cm	584,00
V-K570509	70 x 50 cm	752,00



MI - Mesa total de acero-inox desmontable con estante
Altura total 85 cm.

MI - Total stainless steel detachable table with shelf
 Total height 85 cm.

MI - Table totale d'inox démontable avec étagère
 Hauteur totale 85 cm.

Ref.	Medidas Size Dimensions	Euros
V-MI10060C	100 x 60 cm	507,00
V-MI10070C	100 x 70 cm	535,00
V-MI15060C	150 x 60 cm	593,00
V-MI15070C	150 x 70 cm	650,00
V-MI20060C	200 x 60 cm	714,00
V-MI20070C	200 x 70 cm	800,00

MI - Mesa total de acero-inox desmontable sin estante
Altura total 85 cm.

MI - Total stainless steel detachable table without shelf
 Total height 85 cm.

MI - Table totale d'inox démontable sans étagère
 Hauteur totale 85 cm.

Ref.	Medidas Size Dimensions	Euros
V-MI10060S	100 x 60 cm	479,00
V-MI10070S	100 x 70 cm	500,00
V-MI15060S	150 x 60 cm	550,00
V-MI15070S	150 x 70 cm	595,00
V-MI20060S	200 x 60 cm	671,00
V-MI20070S	200 x 70 cm	739,00



Mesa acero-inox para cortadoras 2 estantes

Stainless steel table for cutters
 2 shelves

Table inox pour cutters 2
 étagères

Ref.	Medidas Size Dimensions	Euros
V-MI7050	70 x 50 x 85 cm	455,00



Mesa acero-inox para sierra 1 estante

Stainless steel table for saw
 1 shelf

Table inox pour scie 1 étagère

Ref.	Medidas Size Dimensions	Euros
V-MI5050	50 x 50 x 65 cm	335,00

Soporte mostrador acero-inox, 2 patas con guías regulables
Altura mínima 80, máxima 88 cm.

Stainless steel counter support,
 2 legs with fittable guides
 Minimum height 80, maximum
 88 cm.

Support comptoir inox, 2 pattes
 avec guides réglables
 Hauteur minimum 80, maximum
 88 cm.

Ref.	Medidas Size Dimensions	Euros
V-MIS	69 x 49 cm	348,00



MM - Mesa de acero-inox con sobre mixto con estante
Con banda de 30 cm de polietileno de 2 cm grosor. Altura total 85
cm. En blanco (X=B) ó rojo (X=R).

MM - Stainless steel table with mixed top and shelf
 With 30 cm polyethylene board of 2 cm thickness. Total height 85 cm.
 In white (X=B) or red (X=R).

MM - Table acier inox avec surface mixte et étagère
 Table de 30 cm en poléthylène de 2 cm d'épaisseur. Hauteur totale
 85 cm. En blanc (X=B) ou rouge (X=R).

MM - Mesa de acero-inox con sobre mixto sin estante
Con banda de 30 cm de polietileno de 2 cm grosor. Altura total 85
cm. En blanco (X=B) ó rojo (X=R).

MM - Stainless steel table with mixed top and without shelf
 With 30 cm polyethylene board of 2 cm thickness. Total height 85 cm.
 In white (X=B) or red (X=R).

MM - Table acier inox avec surface mixte et sans étagère
 Table de 30 cm en poléthylène de 2 cm d'épaisseur. Hauteur totale
 85 cm. En blanc (X=B) ou rouge (X=R).

Ref.	Medidas Size Dimensions	Euros
V-MM10060XS	100 x 60 cm	932,00
V-MM10070XS	100 x 70 cm	1075,00
V-MM15060XS	150 x 60 cm	1089,00
V-MM15070XS	150 x 70 cm	1238,00
V-MM20060XS	200 x 60 cm	1277,00
V-MM20070XS	200 x 70 cm	1457,00

Ref.	Medidas Size Dimensions	Euros
V-MM10060XC	100 x 60 cm	972,00
V-MM10070XC	100 x 70 cm	1124,00
V-MM15060XC	150 x 60 cm	1135,00
V-MM15070XC	150 x 70 cm	1293,00
V-MM20060XC	200 x 60 cm	1336,00
V-MM20070XC	200 x 70 cm	1509,00

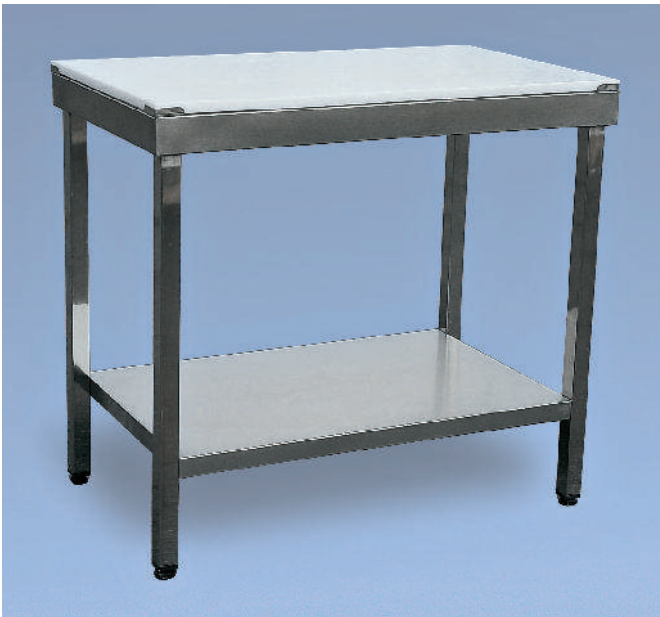

MP - Mesa acero-inox con sobre total de polietileno sin estante
Con Sobre total de polietileno de 2 cm de grosor. Altura total 87
cm. En blanco (X=B) ó rojo (X=R).

MP - Stainless steel table with total polyethylene top without shelf
 Polyethylene top of 2 cm thickness. Total height 87 cm. In white
 (X=B) or red (X=R).

MP - Table acier inox avec surface en poléthylène sans étagère
 Polyéthylène de 2 cm d'épaisseur. Hauteur totale 87 cm. En blanc
 (X=B) ou rouge (X=R).

MP - Mesa acero-inox con sobre total de polietileno con estante
Con Sobre total de polietileno de 2 cm de grosor. Altura total 87
cm. En blanco (X=B) ó rojo (X=R).

MP - Stainless steel table with total polyethylene top with shelf
 Polyethylene top of 2 cm thickness. Total height 87 cm. In white
 (X=B) or red (X=R).

MP - Table acier inox avec surface en poléthylène avec étagère
 Polyéthylène de 2 cm d'épaisseur. Hauteur totale 87 cm. En blanc
 (X=B) ou rouge (X=R).

Ref.	Medidas Size Dimensions	Euros
V-MP10060XC	100 x 60 cm	908,00
V-MP10070XC	100 x 70 cm	1075,00
V-MP15060XC	150 x 60 cm	1102,00
V-MP15070XC	150 x 70 cm	1260,00
V-MP20060XC	200 x 60 cm	1305,00
V-MP20070XC	200 x 70 cm	1492,00

Ref.	Medidas Size Dimensions	Euros
V-MP10060XS	100 x 60 cm	881,00
V-MP10070XS	100 x 70 cm	1026,00
V-MP15060XS	150 x 60 cm	1053,00
V-MP15070XS	150 x 70 cm	1205,00
V-MP20060XS	200 x 60 cm	1249,00
V-MP20070XS	200 x 70 cm	1427,00



MX - Mesa de acero-inox económica con sobre total de polietileno con estante
Con sobre total de polietileno de 2 cm de grosor. Altura total 85 cm. En blanco (X=B) ó rojo (X=R).

MX - Stainless steel economic table with total polyethylene top and shelf
 Total polyethylene top de 2 cm thickness. Total height 85 cm. In white (X=B) or red (X=R).

MX - Table acier inox économique avec surface en polyéthylène avec étagère
 Surface en polyéthylène de 2 cm d'épaisseur. Hauteur totale 85 cm. En blanc (X=B) ou rouge (X=R).

Ref.	Medidas Size Dimensions	Euros
V-MX10050XC	100 x 50 cm	598,00
V-MX10060XC	100 x 60 cm	640,00
V-MX10070XC	100 x 70 cm	741,00
V-MX15050XC	150 x 50 cm	722,00
V-MX15060XC	150 x 60 cm	772,00
V-MX15070XC	150 x 70 cm	876,00
V-MX20050XC	200 x 50 cm	863,00
V-MX20060XC	200 x 60 cm	920,00
V-MX20070XC	200 x 70 cm	1054,00

MX - Mesa de acero-inox económica con sobre total de polietileno sin estante
Con sobre total de polietileno de 2 cm de grosor. Altura total 85 cm. En blanco (X=B) ó rojo (X=R).

MX - Stainless steel economic table with total polyethylene top and without shelf
 Total polyethylene top de 2 cm thickness. Total height 85 cm. In white (X=B) or red (X=R).

MX - Table acier inox économique avec surface en polyéthylène avec sans étagère
 Surface en polyéthylène de 2 cm d'épaisseur. Hauteur totale 85 cm. En blanc (X=B) ou rouge (X=R).

Ref.	Medidas Size Dimensions	Euros
V-MX10050XS	100 x 50 cm	555,00
V-MX10060XS	100 x 60 cm	597,00
V-MX10070XS	100 x 70 cm	693,00
V-MX15050XS	150 x 50 cm	641,00
V-MX15060XS	150 x 60 cm	691,00
V-MX15070XS	150 x 70 cm	787,00
V-MX20050XS	200 x 50 cm	745,00
V-MX20060XS	200 x 60 cm	802,00
V-MX20070XS	200 x 70 cm	894,00

ARTÍCULOS MESA POLIETILENO PE 500 | POLYETHYLENE TABLE ARTICLES | ACCESOIRES DE CUISINE EN POLYÉTHYLÈNE



Tabla canal recoge-jugos
En Blanco (Ref + B) y Rojo (Ref + R)

Cutting board with juice canal
 In White (Ref. + B) and Red (Ref. + R)

Planche avec canal pour garder le jus
 Couleurs Blanc (Réf. + B) et Rouge (Réf. + R)

Ref.	Medidas Size Dimensions	Euros
V-HC3320	33 x 20 x 1,5	15,50
V-HC5020	50 x 20 x 1,5	24,50
V-HC10020	100 x 20 x 1,5	38,00

Plato pulpo

Octopus plate

Assiette poulpe

Ref.	Diámetro Diameter	Altura Height	Euros
A-48-18	Ø 18 cm	2 cm	14,50
A-48-22	Ø 22 cm	2 cm	18,50
A-48-26	Ø 26 cm	2 cm	23,50



Tabla ranuras pan, salmón

Bread utting board, salmon

Planche pour couper le pain, saumon

Ref.	Medidas Size Dimensions	Euros
V-HRP-40302S	40 x 30 x 2 cm	32,00



Mano para colador chino

Handle for placing cone strainer 45 cm

Triangle pour passoire chinois 45 cm

Ref.	Euros
A-42	28,00



Triángulo para colador chino 45 cm

Triangle for placing cone strainer 45 cm

Triangle pour passoire chinois 45 cm

Ref.	Euros
A-41	28,00



Mortero sin mano

Mortar

Mortier

Ref.	Diámetro Diameter Diamètre	Euros
A-43	Ø 18 cm	68,00
A-43-P	Ø 14 cm	48,00



Mano mortero A-43

Pestle for A-43

Pilon pour mortier A-43

Ref.	Medidas Size Dimensions	Euros
A-44	20 x 5 cm	15,00
N A-44-P	18,5 x 4,5 cm	13,50

Rodillo amasador

Dough roller

Rouleau à pâtisserie

Ref.	Diámetro Diameter Diamètre	Largo Long Longueur	Euros
A-46	Ø 5 cm	50 cm	30,50
A-47	Ø 6 cm	60 cm	37,00





Maza para picar hielo Polietileno + Inox.

Mace ice crushing Polieliteno + Inox.

Glace pilée maza Polietileno + Inox.

Ref.	Medidas Size Dimensions	Euros
A-57	6 x 6 x 10 cm	19,00

PALAS POLIETILENO | POLYETHYLENE SLICES | PALLES EN POLYÉTHYLÈNE

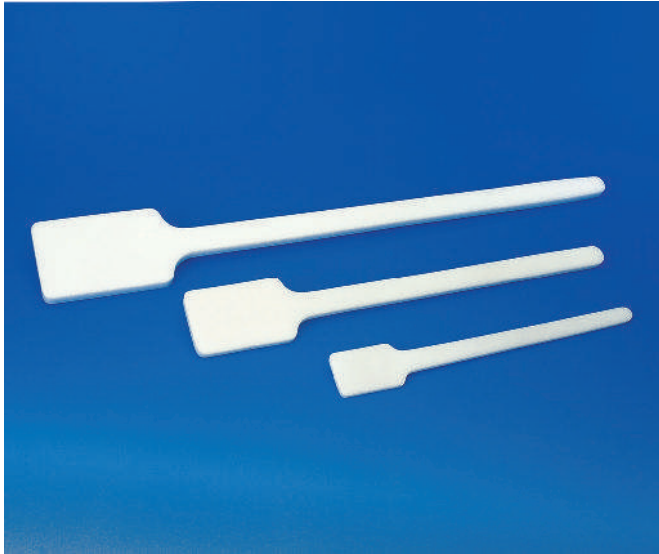

Pala polietileno

Polyethylene slice

Palle en polyéthylène

Ref.	Largo Long Longueur	Euros
A-30-50	50 cm	11,00
A-30-70	70 cm	17,00
A-30-100	100 cm	24,00



Pala polietileno + inox

Polyethylene slice + stainless steel

Palle en polyéthylène + inox

Ref.	Largo Long Longueur	Euros
A-30-50-I	50 cm	34,00
A-30-70-I	70 cm	39,00
A-30-100-I	100 cm	55,00

SOPORTE TABLAS POLIETILENO | POLYETHYLENE BOARDS STAND | SUPPORT PLAQUES POLIÉTHYLÈNE



Soporte tabla polietileno acero-inox (máx. grueso 3 cm)

Stainless steel polyethylene board support

Support plache polyéthylène acier inox

Ref.	Euros
SPI-6	44,00



Soporte polietileno

Polyethylene stand

Support polyéthylène

Ref.	Medidas Size Dimensions	Color Colour Couleur	Euros
V-SP2B	27 x 19 x 3 cm	○	30,50
V-SP2R	27 x 19 x 3 cm	●	30,50

Soporte polietileno mármoleo

Marble imitation polyethylene stand

Support polyéthylène marbre

Ref.	Medidas Size Dimensions	Euros
V-SP2M	27 x 19 x 3 cm	30,50



Tabla corte con cubeta
Con guías para cubeta gastronorm GI-1/2-65. Altura 10 cm

Cuvette cutting board
With gastronorm tray guides GI-1 / 2-65.
Height 10 cm

Planche à découper cuvette
Avec guides de plateaux gastronorm GI-1 / 2-65. Hauteur 10 cm

Ref.	Medidas Size Dimensions	Euros
V-HG40302V	40 x 30 x 2 cm	55,00



Tabla madera presentación
Con dos listones inferiores

Wood presentation table
With two lower slats

Table de présentation en bois
Avec deux lattes inférieures

Ref.	Medidas Size Dimensions	Euros
V-TP30202	30 x 20 x 2 cm	25,00
V-TP35252	35 x 25 x 2 cm	37,00



Mesa cocina madera
Con dos estantes y cuatro ruedas giratorias con freno. Altura 90 cm

Wood kitchen table
With two shelves and four rotating wheels
with brake. Height 90 cm

Table de cuisine en bois
Avec deux étagères et quatre roues en
rotation avec frein. Hauteur 90 cm

Ref.	Medidas Size Dimensions	Euros
V-MC60505-R	60 x 50 x 5 cm	450,00

Mesa cocina madera
Con dos estantes. Altura 90 cm

Wood kitchen table
With two shelves. Height 90 cm

Table de cuisine en bois
Avec deux étagères. Hauteur 90 cm

Ref.	Medidas Size Dimensions	Euros
V-MC60505	60 x 50 x 5 cm	380,00



0

2

**Carteles portaprecios, Peana - Plataformas -
Pinzas, Listas de precios, Carteles señalización,
Guirnaldas, Separadores, Barreños, Base
rodante, Cubetas, Bandejas, Gastronorm,
PlexiLine.**

Price tag holder, Stand - platforms - Clips, Price
lists, Sign, Garlands, Separators, Tubs, Rolling
base, Containers, Trays, Gastronorm, PlexiLine.

*Affiches porte prix, Socle - plate-formes - clips,
Liste prix, Affiches signalization, Guirlandes,
Séparateurs, Bassines, Base roulante, Bacs,
Plateaux, Gastronorm, PlexiLine.*

21 - 62



Porcino, num. relieve, con base

Pork, num. relief, with base

Porcin, num. relief, avec base

Ref.	Medidas Size Dimensions	Unidades Units Unités	Euros
C-300	8,5 x 6,5	12	64,00



Ternera, num. relieve, con base

Veal, num. relief, with base

Veau, num. relief, avec base

Ref.	Medidas Size Dimensions	Unidades Units Unités	Euros
C-301	8,5 x 6,5	12	64,00



Cordero, num. relieve, con base

Lamb, num. relief, with, base

Agneau, num. relief, avec base

Ref.	Medidas Size Dimensions	Unidades Units Unités	Euros
C-302	8,5 x 6,5	12	64,00



Pollo, num. relieve, con base

Chicken, num. relief, with base

Poulet, num. relief, avec base

Ref.	Medidas Size Dimensions	Unidades Units Unités	Euros
C-303	8,5 x 6,5	12	64,00



Charcutería, num. relieve, con base

Charcuterie, num. relief, with base

Charcuterie, num. relief, avec base

Ref.	Medidas Size Dimensions	Unidades Units Unités	Euros
C-304	8,5 x 6,5	12	64,00



Quesos, num. relieve, con base

Cheeses, num. relief, with base

Fromages, num. relief, avec base

Ref.	Medidas Size Dimensions	Unidades Units Unités	Euros
C-305	8,5 x 6,5	12	64,00

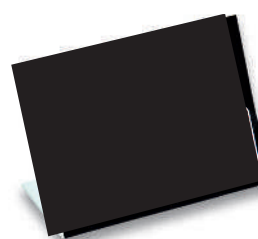

Liso Pizarra

Plane board

Tableau lisse

Ref.	Medidas Size Dimensions	Unidades Units Unités	Euros
C-307	8,5 x 6,5 cm	12	58,00



Panadería/Pastelería, num. relieve, con base

Bakery/Pastry, num. relief, with base

Boulangerie/Pâtisserie, num. relief, avec base

Ref.	Medidas Size Dimensions	Unidades Units Unités	Euros
C-306	8,5 x 6,5	12	64,00



Porcino, num. relieve, con base

Pork, num. relief, with base

Porcin, num. relief, avec base

Ref.	Medidas Size Dimensions	Unidades Units Unités	Euros
C-310	10,5 x 7,5	12	67,00

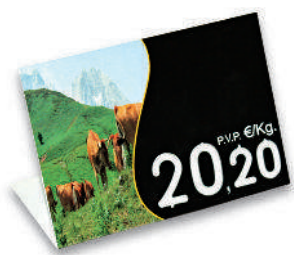

Ternera, num. relieve, con base

Veal, num. relief, with base

Veau, num. relief, avec base

Ref.	Medidas Size Dimensions	Unidades Units Unités	Euros
C-311	10,5 x 7,5	12	67,00



Cordero, num. relieve, con base

Lamb, num. relief, with base

Agneau, num. relief, avec base

Ref.	Medidas Size Dimensions	Unidades Units Unités	Euros
C-312	10,5 x 7,5	12	67,00



Pollo, num. relieve, con base

Chicken, num. relief, with base

Poulet, num. relief, avec base

Ref.	Medidas Size Dimensions	Unidades Units Unités	Euros
C-313	10,5 x 7,5	12	67,00



Charcutería, num. relieve, con base

Charcutería, num. relieve, with base

Charcuterie, num. relief, avec, base

Ref.	Medidas Size Dimensions	Unidades Units Unités	Euros
C-314	10,5 x 7,5	12	67,00



Quesos, num. relieve, con base

Cheeses, num. relief, with base

Fromages, num. relief, avec base

Ref.	Medidas Size Dimensions	Unidades Units Unités	Euros
C-315	10,5 x 7,5	12	67,00



Liso pizarra

Plane board

Tableau lisse

Ref.	Medidas Size Dimensions	Unidades Units Unités	Euros
C-317	10,5 x 7,5 cm	12	60,00



Frutas, nº relieve, con ganchos

Fruits, num. relief, with hooks

Fruits, num. relief, avec crochets

Ref.	Medidas Size Dimensions	Unidades Units Unités	Euros
C-320	13 x 9,5	12	70,00

Material Glaspar, con pincho acero-inoxidable, arandela de plástico y remaches de plástico

Made on Glaspar material, spike of Stainless Steel, plastic round base and Plastic rivets

Matériel Glaspar, pique en acier Inox, rondelle plastique et rivets plastiques



Nº ruedas, fondo rojo

Num. rotating, red deep

Num. roulette, fond rouge

Ref.	Medidas Size Dimensions	Unidades Units Unités	Euros
C-10	8 x 7	12	26,00



Nº ruedas 8x7 fondo azul

Num rotating 8x7 cm blue deep

Num. roulettes 8x7 cm fond bleu

Ref.	Medidas Size Dimensions	Unidades Units Unités	Euros
C-10-AZ	8 x 7	12	26,00



Nº ruedas, fondo blanco

Num. rotating, white deep

Num. roulettes, fond blanc

Ref.	Medidas Size Dimensions	Unidades Units Unités	Euros
C-10-B	8 x 7	12	26,00



Nº ruedas 10x7,5 cm. fondo rojo

Num. rotating 10x7,5 cm. red deep

Num. roulettes 10x7,5 fond rouge

Ref.	Medidas Size Dimensions	Unidades Units Unités	Euros
C-11	10 x 7,5	12	27,00



Nº ruedas, fondo azul

Num. rotating, blue deep

Num. roulettes, fond bleu

Ref.	Medidas Size Dimensions	Unidades Units Unités	Euros
C-11-AZ	10 x 7,5	12	27,00



Nº ruedas, fondo blanco

Num. rotating, white deep

Num. roulettes, fond blanc

Ref.	Medidas Size Dimensions	Unidades Units Unités	Euros
C-11-B	10 x 7,5	12	27,00



Nº ruedas, rojo, con rueda para indicar kg-unidades-100gr. - 1/4

Num. rotating, red, wheel for kilo-unit - 100 gr. - 1/4

Nº roulettes, rouge, roulette pour kilo-unité, 100 gr. - 1/4

Ref.	Medidas Size Dimensions	Unidades Units Unités	Euros
C-65-R	11 x 7,5	12	31,00



Nº ruedas, azul, con rueda para indicar kilo-unid. -100 gr., 1/4

Num. rotating, blue, wheel for kilo-unit - 100 gr. - 1/4

Nº roulettes, pré, roulette pour kilo-unité - 100 gr. - 1/4

Ref.	Medidas Size Dimensions	Unidades Units Unités	Euros
C-65-AZ	11 x 7,5	12	31,00



Nº ruedas, verde, con rueda para indicar kilo-unidad - 100 gr. - 1/4

Num. rotating, green, wheel for kilo-unit-100 gr. - 1/4

Num. roulettes, vert, roulette pour kilo-unité-100 gr. - 1/4

Ref.	Medidas Size Dimensions	Unidades Units Unités	Euros
C-65-V	11 x 7,5	12	31,00

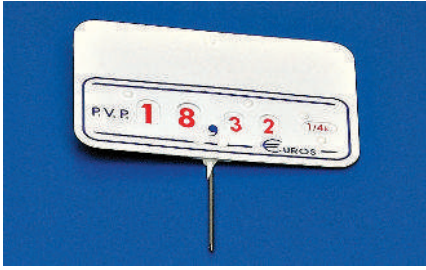

Nº ruedas, blanco, con rueda para indicar kilo-unid.- 100 gr. - 1/4

Num. rotating, white, wheel for kilo-unit - 100 gr. - 1/4

Num. roulettes, white, roulette pour kilo-unité - 100 gr. - 1/4

Ref.	Medidas Size Dimensions	Unidades Units Unités	Euros
C-65-B	11 x 7,5	12	31,00



Nº ruedas, naranja

Num. rotating orange

Num. roulettes fond rouge orange

Ref.	Medidas Size Dimensions	Unidades Units Unités	Euros
C-15-N	13 x 10 v	12	35,00

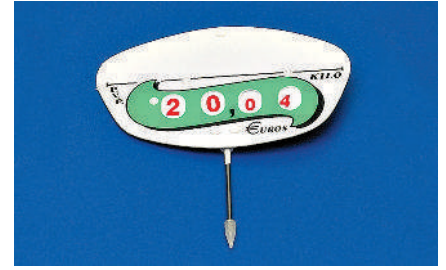

Nº ruedas

Num. rotating

Nº roulettes

Ref.	Medidas Size Dimensions	Unidades Units Unités	Euros
C-17	11 x 7,5	12	28,00



Nº ruedas - Pescadero normativa

Num. rotating - Fish regulations

Num. roulettes - Poisson regulations

Ref.	Medidas Size Dimensions	Unidades Units Unités	Euros
C-24	13 x 9	12	45,00



Nº ruedas - Pescadero normativa - Con base

Num. rotating - Fish regulations

Num. roulettes - Poisson regulations

Ref.	Medidas Size Dimensions	Unidades Units Unités	Euros
C-24-B	12 x 8	12	52,00



Nº ruedas - Pescadero normativa - Portatarjeta

Num. rotating - Fish regulations

Nº roulettes - Poisson regulations

Ref.	Medidas Size Dimensions	Unidades Units Unités	Euros
C-24-T	12 x 8	12	61,00



Pescadería, nº relieve, con base

Fish, num.relief, with base

Poisson, num. relief, avc base

Ref.	Medidas Size Dimensions	Unidades Units Unités	Euros
C-321	13 x 9,5 cm	12	70,00



Nº ruedas, prado, Rueda para indicar kilo-unid. - 100 gr. - 1/4

Num. rotating, Meadow, with wheel for kilo-unit-100 gr - 1/4

Num roulettes, Pré, roulette pour kilo-unité-100 gr. - 1/4

Ref.	Medidas Size Dimensions	Unidades Units Unités	Euros
C-38	11 x 7,5	12	39,00



Nº ruedas, pergamino, con rueda para indicar kilo-unidad - 100 gr. - 1/4

Num. rotating, scroll, with wheel for kilo-unit - 100gr. - 1/4

Num. roulettes, parchemin, roulette pour kilo-unité - 100 gr. - 1/4

Ref.	Medidas Size Dimensions	Unidades Units Unités	Euros
C-66	11 x 7,5	12	33,00



Nº ruedas, pergamino

Num. rotating, scroll

Num. roulettes, fond rouge parchemin

Ref.	Medidas Size Dimensions	Unidades Units Unités	Euros
C-13	13 x 10	12	37,00



Nº ruedas, 3+2 dígitos fondo blanco

Num. rotating, 3+2 digits white deep

Num. roulette, 3+2 chiffres - fond blanc

Ref.	Medidas Size Dimensions	Unidades Units Unités	Euros
C-90-B	13 x 8	12	37,00



Nº ruedas, 3+2 dígitos fondo azul

Num. rotating, 3+2 digits blue deep

Num. roulette, 3+2 chiffres - fond bleu

Ref.	Medidas Size Dimensions	Unidades Units Unités	Euros
C-90-AZ	13 x 8	12	37,00



Nº ruedas, 3+2 dígitos fondo rojo

Num. rotating, 3+2 digits red deep

Num. roulette, 3+2 chiffres - fond rouge

Ref.	Medidas Size Dimensions	Unidades Units Unités	Euros
C-90-R	13 x 8	12	37,00

CARTELES PORTAPRECIOS BASE | BASE PRICE TAG HOLDER | AFFICHES PORTE PRIX BASE

Material Glaspar, con pincho acero-inoxidable, arandela de plástico y remaches de plástico

Made on Glaspar material, spike of stainless steel, plastic round base and plastic rivets

Matériel Glaspar, pique en acier inox, rondelle plastique et rivets plastiques

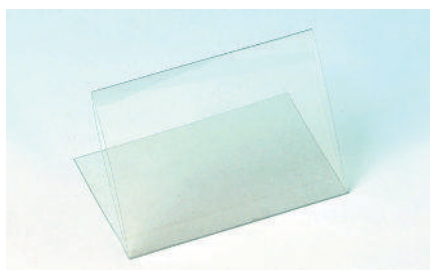

Porta tarjeta transparente con base

Transparent card holder with base

Porte-carte transparent avec base

Ref.	Medidas Size Dimensions	Unidades Units Unités	Euros
C-132	9,5 x 7	12	21,00

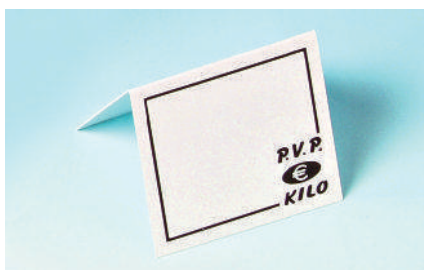

Cartel doble cara liso

Two-faced tag plane

Affiche de double face lisse

Ref.	Medidas Size Dimensions	Unidades Units Unités	Euros
C-140	7 x 6	12	21,00



Cartel doble cara liso

Two-faced tag plane

Affiche de double face lisse

Ref.	Medidas Size Dimensions	Unidades Units Unités	Euros
C-141	12 x 8	12	29,00



Nº ruedas, azul con rueda para indicar kilo-unid. - 100 gr. - 1/4, con base

Num. rotating, blue, with wheel for kilo-unit-100 gr.-1/4, with base

Num. roulettes, bleu, avec roulette pour kilo-unit-100 gr.-1/4, avec base

Ref.	Medidas Size Dimensions	Unidades Units Unités	Euros
C-65-AZB	11 x 7,5	9	39,00



Nº ruedas, rojo con rueda para indicar kilo-unid. - 100 gr. - 1/4

Num. rotating, red, with wheel for kilo-unit - 100 gr. - 1/4

Num. roulettes, rouge, avec roulette pour kilo-unité - 100 gr. - 1/4

Ref.	Medidas Size Dimensions	Unidades Units Unités	Euros
C-65-RB	11 x 7,5	12	39,00



Nº ruedas verde, con rueda para indicar Kg-unid.-100 gr.-1/4, con base

Num. rotating, green, 11x7,5 cm., con rueda para indicar Kg.-unid.-100 gr.-1/4, with base

Num. roulettes, vert, avec roulette pour Kg.-unit-100 gr.-1/4, avec base

Ref.	Medidas Size Dimensions	Unidades Units Unités	Euros
C-65-VB	11 x 7,5	12	39,00



Nº ruedas, blanco, con rueda para indicar kilo-unid.- 100 gr. - 1/4

Num. rotating, white, 11x7,5 cm., wheel for kilo-unit - 100 gr. - 1/4

Num. roulettes, white, 11x7,5 cm., roulette pour kilo-unité - 100 gr. - 1/4

Ref.	Medidas Size Dimensions	Unidades Units Unités	Euros
C-65-BB	11 x 7,5	12	39,00



Nº ruedas, pergamino, con rueda para indicar Kg-unid.-100 gr.-1/4, con base

Num. rotating, scroll, with wheel for kilo-unit-100 gr.- 1/4, with base

Num. roulettes, parchemin, avec roulette pour kilo-unité-100 gr.-1/4, avec base

Ref.	Medidas Size Dimensions	Unidades Units Unités	Euros
C-66-B	11 x 7,5	12	40,00

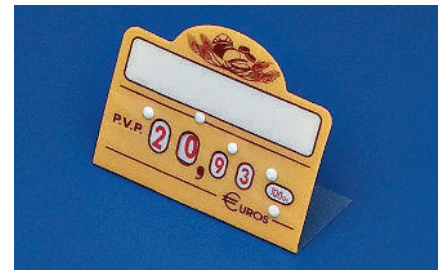

Nº ruedas, con plataforma panadería-pastelería

Num. rotating, bakery

Num. roulettes, boulangerie

Ref.	Medidas Size Dimensions	Unidades Units Unités	Euros
C-67	8,5 x 6,5	12	29,00



Nº ruedas, con plataforma, azul

Num. rotating, with base, blue

Num. roulettes, avec base, bleu

Ref.	Medidas Size Dimensions	Unidades Units Unités	Euros
C-67-AZ	8,5 x 6,5	12	29,00



Nº ruedas, con plataforma, rojo

Num. rotating, red, with base

Num. roulettees, rouge, avec base

Ref.	Medidas Size Dimensions	Unidades Units Unités	Euros
C-67-R	8,5 x 6,5	12	29,00



Nº ruedas, prado con rueda para indicar Kg.-unid. - 100 gr. - 1/4, con base

Num. rotating, meadow, kilo-unit-100 gr. - 1/4, with base

Num. roulettes, pré, kilo-unité-100 gr.- 1/4, avec base

Ref.	Medidas Size Dimensions	Unidades Units Unités	Euros
C-38-B	11 x 7,5	12	47,00



Liso con base

Plane with base

Lisse avec base

Ref.	Medidas Size Dimensions	Unidades Units Unités	Euros
C-7-B	10 x 7	12	28,00

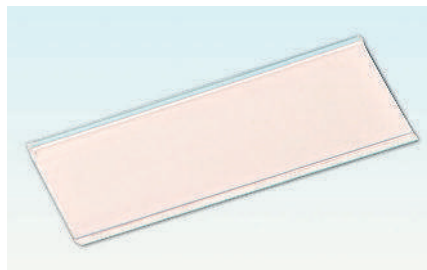

**Guía adhesiva para etiquetas,
transparente**

Transparent adhesive label holder

Tringle adhésive transparent pour étiquettes

Ref.	Medidas Size Dimensions	Euros
C-130	10 x 4	10,00

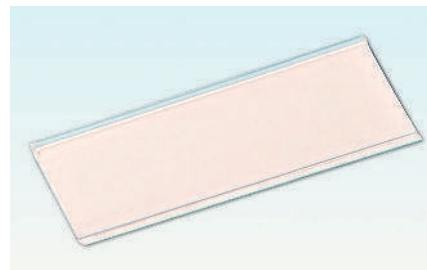

**Guía adhesiva para etiquetas, 100x4 cm,
transparente**

Transparent adhesive label holder, 100x4 cm

Tringle adhésive transparent pour étiquettes, 100x4 cm

Ref.	Euros
C-131	8,00

CARTELES PORTAPRECIOS LISOS-DIGITAL | SMOOTH LABELED DIGITAL PRICE TAG HOLDERS | AFFICHES PORTE PRIX LISSE-DIGITAL

Material: Glaspar, Pincho: Acero-inox, Arandela: Plástico, Remaches:Plástico

Material: Glaspar, Spike: Stainless Steel, Round base: Plastic, Rivets: Plastic

Matériel: Glaspar, Pique: Acier inox, Rondelle: Plastique, Rivets: Plastique



Nº digital fondo azul

Num. digital blue deep

Num. digital fond bleu

Ref.	Medidas Size Dimensions	Unidades Units Unités	Euros
C-91	11 x 8	12	21,00



Nº digital fondo rojo

Num. digital red deep

Num. digital fond bleu

Ref.	Medidas Size Dimensions	Unidades Units Unités	Euros
C-92	11 x 8	12	21,00



Liso pizarra con pincho

Smooth slate with skewerSmooth slate with skewer

Ardoise lisse avec pin

Ref.	Medidas Size Dimensions	Unidades Units Unités	Euros
C-97	8,5 x 6,5 cm	12	14,00
C-98	15,5 x 9 cm	12	21,00



Liso pizarra sin pincho

Smooth slate with skewerSmooth slate without skewer

Ardoise lisse sans pin

Ref.	Medidas Size Dimensions	Unidades Units Unités	Euros
C-97-N	8,5 x 6,5 cm	12	14,00
C-98-N	15,5 x 9 cm	12	21,00



Dorado rectangular

Golden rectangular

Rectangulaire dorée

Ref.	Medidas Size Dimensions	Unidades Units Unités	Euros
C-81	6 x 4	12	9,00



Dorado oval

Golden oval

Ovale dorée

Ref.	Medidas Size Dimensions	Unidades Units Unités	Euros
C-82	5 x 4	12	9,00



Visera oferta para carteles ruedas

Offer top for rotating tags

Visière d'offre pour affiches roulettes

Ref.	Unidades Units Unités	Euros
C-2	12	15,00

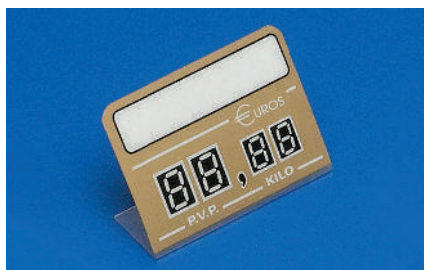

Nº digital fondo dorado

Num. digital golden deep

Num. digital fond doré

Ref.	Medidas Size Dimensions	Unidades Units Unités	Euros
C-99	11 x 8	12	21,00



Liso Panadería-Pastelería

Plane bakery/Pâtisserie

Lisse Boulangerie/Pâtisserie

Ref.	Medidas Size Dimensions	Unidades Units Unités	Euros
C-39	8,5 x 6	12	17,00



Liso

Plane

Lisse

Ref.	Medidas Size Dimensions	Unidades Units Unités	Euros
C-7	10 x 7	12	21,00



Rotulador para carteles digitales y rotulación producto

Marker for digital tags and product signages

Marqueur pour les affiches digitales et marquages de produits

Ref.	Euros
C-100	4,00



Inyección con guía para etiqueta, masa roja

Injection with place to fit label, red Material : injected plastic

Stainless steel pin

Injection avec tringle pour étiquette, rouge Matériel: plastique injecté

Pique : acier inox.

Ref.	Medidas Size Dimensions	Unidades Units Unités	Euros
C-42-GR	10 x 7	12	41,00



Inyección con guía para etiqueta, masa azul

Injection with place to fit label, 10x7 cm, blue

Injection avec tringle pour étiquette, 10x7 cm, bleu

Ref.	Medidas Size Dimensions	Unidades Units Unités	Euros
C-42-GAZ	10 x 7	12	41,00



Inyección con guía para etiqueta, blanco

Injection with place to fit label, white

Injection avec tringle pour étiquette, blanc

Ref.	Medidas Size Dimensions	Unidades Units Unités	Euros
C-42-G	10 x 7	12	41,00



Inyección con guía para etiqueta, masa marrón

Injection with place to fit label, brown

Injection avec tringle pour étiquette, marron

Ref.	Medidas Size Dimensions	Unidades Units Unités	Euros
C-42-GM	10 x 7	12	41,00

Material : Plástico inyectado - Pincho : Acero inox. - Números : Relieve

Material: Injected Plastic - Pin: Stainless Steel - Numbers: Relief

Matériel : Plastique injecté - Pique: Acier inox. - Chiffres: Relief



Inyección, N° relieve, azul

Injection, num. relief, blue

Injection, num. relief, bleu

Ref.	Medidas Size Dimensions	Unidades Units Unités	Euros
C-44-AZ	9 x 7,5	24	98,00



Inyección, N° relieve, blanco

Injection, num. relief, white

Injection, num. relief, blanc

Ref.	Medidas Size Dimensions	Unidades Units Unités	Euros
C-44-B	9 x 7,5	24	98,00



Inyección, N° relieve, crema

Injection, num. relief, beige

Injection, num. relief, beige

Ref.	Medidas Size Dimensions	Unidades Units Unités	Euros
C-44-C	9 x 7,5	24	98,00



Inyección, N° relieve, marrón

Injection, num. relief, brown

Injection, num. relief, marron

Ref.	Medidas Size Dimensions	Unidades Units Unités	Euros
C-44-M	9 x 7,5	24	98,00



Inyección, N° relieve, rojo

Injection, num. relief, red

Injection, num. relief, rouge

Ref.	Medidas Size Dimensions	Unidades Units Unités	Euros
C-44-R	9 x 7,5	24	98,00



Inyección, N° relieve, blanco masa azul

Injection, N° relief, white blue top

Injection, num. relief, blanc tête bleu

Ref.	Medidas Size Dimensions	Unidades Units Unités	Euros
C-44-BAZ	9 x 7,5	24	98,00



Inyección, N° relieve, blanco masa rojo

Injection, num. relief, 9x7,5 cm, white red top

Injection, num. relief, 9x75, blanc tête rouge

Ref.	Medidas Size Dimensions	Unidades Units Unités	Euros
C-44-BR	9 x 7,5	24	98,00



Inyección, N° relieve, blanco masa verde

Injection, num. relief, white and green top

Injection, num. relief, blanc et tête vert

Ref.	Medidas Size Dimensions	Unidades Units Unités	Euros
C-44-BV	9 x 7,5	24	98,00



Inyección, N° relieve, azul

Injection, num. relief, blue
Material: Injected Plastic - Pin: Stainless Steel - Numbers: Relief

injection, num. relief, bleu

Ref.	Medidas Size Dimensions	Unidades Units Unités	Euros
C-42-AZ	10 x 7	24	85,00



Inyección, Nº relieve, blanco

Injection num. relief, white

Injection, num. relief, blanc

Ref.	Medidas Size Dimensions	Unidades Units Unités	Euros
C-42-B	10 x 7	24	85,00

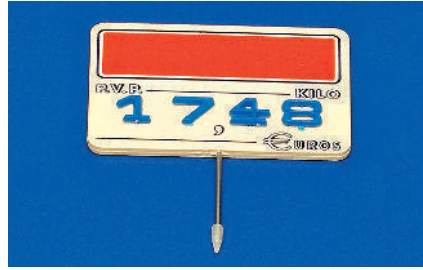

Inyección, Nº relieve, crema

Injection num. relief, beige

Injection, num. relief beige

Ref.	Medidas Size Dimensions	Unidades Units Unités	Euros
C-42-C	10 x 7	24	85,00



Inyección, Nº relieve, masa roja

Injection, num. relief, red

Injection, num. relief, rouge

Ref.	Medidas Size Dimensions	Unidades Units Unités	Euros
C-42-R	10 x 7	24	85,00



Inyección, Nº relieve, masa green

Injection, num. relief, green

Injection, Nº relief, vert

Ref.	Medidas Size Dimensions	Unidades Units Unités	Euros
C-42-V	10 x 7	24	85,00



Visera oferta para acoplar a ref. C-44

Offer top for fitting on item C-44

Visière d'offre pour réf. C-44

Ref.	Unidades Units Unités	Euros
C-43	12	20,00



Arandela para acoplar ref. C-44

Washer for coupling C-44

Rondelle pour raccorder C-44

Ref.	Unidades Units Unités	Euros
C-43-A	12	5,00

ROTULACIÓN | SIGNAGES | MARQUAGES



Rotulación cartel indicando producto

Tag signage, product indication

Marquage d'affiche, indication de produit

Ref.	Euros
C-51	0,75



Grabado C-42 - C-44

Signage C-42 - C-44

Marquage C-42 - C-44

Ref.	Euros
C-56	1,40

Material: Glaspar - Paleta: Inyección - Ganchos: Acero-Inox - Números : Recambiables - Ruedas

Material: Glaspar - Spatula: Injection - Hangers: Stainless Steel - Numbers: changeable - Wheels

Matériel: Glaspar - Palette: Injection - Crochets: Acier Inox. - Chiffres: interchangeable - Roulettes



Frutas, nº relieve, con ganchos

Fruits, num. relief, with hooks

Fruits, num. relief, avec crochets

Ref.	Medidas Size Dimensions	Unidades Units Unités	Euros
C-320	13 x 9,5 cm	12	70,00



Oferta, Nº recambiable

Offer, Num. interchangeable

Offre, Num. interchangeable

Ref.	Medidas Size Dimensions	Unidades Units Unités	Euros
C-34	28 x 23,5	6	41,00



Oferta, Nº recambiable

Offer, Num. interchangeable

Offre, Num. interchangeable

Ref.	Medidas Size Dimensions	Unidades Units Unités	Euros
C-35	18 x 12,5	12	46,00



Oferta kilos, Nº recambiable

Kilo offer, Num. interchangeable

Offre kilo, Num. interchangeable

Ref.	Medidas Size Dimensions	Unidades Units Unités	Euros
C-35-K	18 x 12,5	12	50,00



Nº recambiable, Paleta

Num. interchangeable, Palette

Num. interchangeable, Palette

Ref.	Medidas Size Dimensions	Unidades Units Unités	Euros
C-40	19 x 13	12	48,00



Nº recambiable, Ganchos

Num. interchangeable, Hooks

Num. interchangeable, Crochets

Ref.	Medidas Size Dimensions	Euros
C-41	19 x 13	48,00

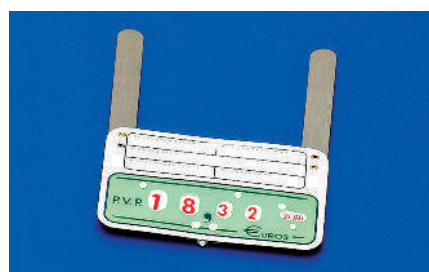

Nº ruedas, Verde, con rueda para indicar kilo - Unid. 100 grs - 1/4

Num. rotating, Green, Wheel for kilo or unit

Num. roulettes, Vert, Roulette pour kilo ou unité

Ref.	Medidas Size Dimensions	Unidades Units Unités	Euros
C-65-VF	11 x 7,5	12	33,00



Nº recambiable, 4 dígitos, Paleta

Num. interchangeable, 4 digits, Palette

Num. interchangeable, 4 digits, Palette

Ref.	Medidas Size Dimensions	Unidades Units Unités	Euros
C-68	18,5 x 12	12	47,00



Num. recambiable, 4 dígitos, Ganchos

Nº interchangeable, 4 digits, Hooks

Nº interchangeable, 4 digits, Crochets

Ref.	Medidas Size Dimensions	Unidades Units Unités	Euros
C-69	18,5 x 12	12	47,00



Nº ruedas, 4 dígitos, Paleta

Num. rotating, 4 digits, Palette

Num. roulettes, 4 digits, Palette

Ref.	Medidas Size Dimensions	Unidades Units Unités	Euros
C-72	18 x 11	12	52,00



Nº ruedas, 4 dígitos, 2 Ganchos

Num. rotating, 4 digits, 2 hooks

Num. roulettes, 4 digits, 2 crochets

Ref.	Medidas Size Dimensions	Unidades Units Unités	Euros
C-73	18 x 11	12	52,00



Oferta kilos, Nº recambiable, Paleta

Kilo offer, Num. interchangeable, Palette

Offre kilo, Nº interchangeable, Palette

Ref.	Medidas Size Dimensions	Unidades Units Unités	Euros
C-74	23,5 x 18,5	6	47,00



Oferta kilos, Nº recambiable, Ganchos,

Kilo offer, Num. interchangeable, Hooks,

Kilo offer, Num. interchangeable, Crochets

Ref.	Medidas Size Dimensions	Unidades Units Unités	Euros
C-75	23 x 18,5	6	47,00



Nº ruedas, Paleta

Num. rotating, Palette

Num. rotating, Palette

Ref.	Medidas Size Dimensions	Unidades Units Unités	Euros
C-76	22 x 14	12	50,00



Frutas, Nº ruedas, Paleta

Fruits, Nº rotating, Palette

Fruits, Nº roulettes, Palette

Ref.	Medidas Size Dimensions	Euros
C-76-C	22 x 14	50,00



Nº ruedas, Paleta, con num. tecla

Num. rotating, Palette, with product ref.

Num. roulettes, Palette, avec réf. du produit

Ref.	Medidas Size Dimensions	Unidades Units Unités	Euros
C-76-T	22 x 14	12	62,00



Nº ruedas, Ganchos, con Nº tecla

Num. rotating, Hooks, with product ref.

Num. roulettes, Palette, avec réf. du produit

Ref.	Unidades Units Unités	Euros
C-77-T	12	62,00



Nº ruedas, Ganchos

Num. rotating, Hooks, Palette

Num. roulettes, Crochets

Ref.	Medidas Size Dimensions	Unidades Units Unités	Euros
C-77	22 x 14	12	50,00

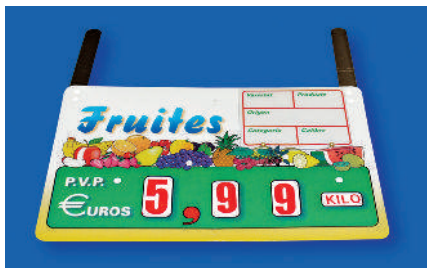

Frutas, Nº ruedas, Ganchos

Fruits, Num. rotating, Hooks

Fruits, Num. roulettes, Crochets

Ref.	Unidades Units Unités	Euros
C-77-C	12	50,00

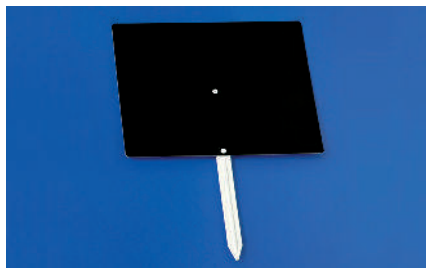

Liso pizarra, Paleta

Plane Board, Palette

Num. roulettes, Crochets, Fruits

Ref.	Medidas Size Dimensions	Unidades Units Unités	Euros
C-93	19 x 12	12	34,00
C-95	24 x 20	12	52,00

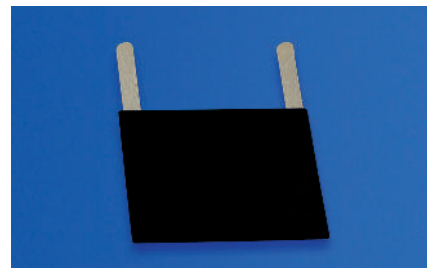

Liso pizarra, Ganchos

Plane board, Hooks

Tableau lisse, Crochets

Ref.	Medidas Size Dimensions	Unidades Units Unités	Euros
C-94	19 x 12	12	34,00
C-96	24 x 20	12	52,00

NÚMEROS RECAMBIABLES | CHANGEABLE NUMBERS | CHIFFRES INTERCHANGEABLES



Núm. recambiable, arandela

Num. rechargeable, washer

Num. rechargeable, ronelle

Ref.	Medidas Size Dimensions	Unidades Units Unités	Euros
C-79	11 x 9 cm	12	34,00



**Pergamino, núm. recambiable
Con pincho acero inoxidable**

Scroll, num. interchangeable
With stainless steel pin

*Parchemin, num. interchangeable
Avec pique en acier inox.*

Ref.	Medidas Size Dimensions	Unidades Units Unités	Euros
C-87	15 x 11 cm	12	37,00



Pergamino, núm. recambiable, arandela

Scroll, num. interchangeable, washer

Parchemin, num. interchangeable, rondelle

Ref.	Medidas Size Dimensions	Unidades Units Unités	Euros
C-87-A	15 x 11 cm	12	37,00



Huevos, núm. recambiable

Eggs, num. interchangeable

Oeufs, num. interchangeable

Ref.	Medidas Size Dimensions	Unidades Units Unités	Euros
C-88	15 x 14 cm	6	35,00



Pergamino, núm. recambiable

Scroll, num. interchangeable

Parchemin, num. interchangeable

Ref.	Medidas Size Dimensions	Unidades Units Unités	Euros
C-89	20 x 15 cm	6	34,00



Peana inox. con tubo

Stainless stand with tube

Inox socle avec tube

Ref.	Altura Height Hauteur	Unidades Units Unités	Euros
C-200	10 cm	6	26,00
C-201	16 cm	6	27,00



Peana inox con varilla

Stainless stand with rod

Inox socle avec brance

Ref.	Altura Height Hauteur	Unidades Units Unités	Euros
C-202	10 cm	6	35,00
C-203	16 cm	6	36,00



Peana inox con pinza

Stainless stand with pincer

Inox socle avec pince

Ref.	Altura Height Hauteur	Unidades Units Unités	Euros
C-205	10 cm	4	30,00

SOPORTES CARTELES INYECCIÓN | INJECTION TAGS STAND | SUPPORT AFFICHES INJECTION



Plataforma con tubo

Platform with tube

Plate-forme avec tube

Ref.	Altura Height Hauteur	Color Colour Couleur	Unidades Units Unités	Euros
C-1	20 cm	○	12	18,00
C-1-N	20 cm	●	12	21,00



Pinza para plataforma C-1

Clip platform C-1

Clip plate-forme C-1

Ref.	Color Colour Couleur	Unidades Units Unités	Euros
C-1-P		12	9,00
C-1-PN	●	12	11,00



Pinza para cubetas

Pincer trays

Pince bac

Ref.	Unidades Units Unités	Euros
C-9	12	15,00



Peana

Stand

Socle

Ref.	Color Colour Couleur	Unidades Units Unités	Euros
C-4-B	○	12	14,00
C-4-M	●	12	14,00

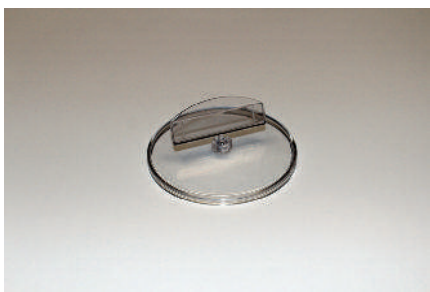

Peana base redonda
Peana base redonda 8,5cm con soporte.

Ref.	Unidades Units Unités	Euros
C-210	10	21,00



Pinza plástica

Plastic salad clip

Pince en plastique

Ref.	Largo Long Longueur	Unidades Units Unités	Euros
C-215-N	80 mm	10	22,00
C-215-B	80 mm	10	22,00



Peana base redonda
Peana base redonda 8,5 cm con soporte
12,5 cm.

Ref.	Unidades Units Unités	Euros
C-211	10	26,00



Pinza abertura máxima
Pinza abertura máxima 3 cm con soporte.

Maximum aperture clamp
Maximum opening with support clamp 3 cm.

Pince d'ouverture maximum
Ouverture maximale avec le support de serrage 3 cm.

Ref.	Unidades Units Unités	Euros
C-212	10	30,00



Pinza abertura máxima
Pinza abertura máxima 1 cm con soporte.

Maximum aperture clamp
Maximum opening with support clamp 1 cm.

Pince d'ouverture maximum
Ouverture maximale avec le support de serrage 3 cm.

Ref.	Unidades Units Unités	Euros
C-213	10	17,00



Pinza abertura máxima
Pinza abertura máxima 1 cm soporte 15 cm.

Maximum aperture clamp
Maximum aperture support gripper 1 cm 15 cm.

Pince d'ouverture maximum
Ouverture maximale support pince 1 cm à 15 cm.

Ref.	Unidades Units Unités	Euros
C-214	10	22,00

Material: Glaspar, Números recambiables

Material: Glaspar, Numbers changeable

Matériel: Glaspar, Chiffres interchangeables



Polleria Combinada

Poultry store Combined

Volaille Combinée

Ref.	Medidas Size Dimensions	Euros
C-25	39 x 35	26,00



Lista oficial porcino

Pork official list

Officiel porcin

Ref.	Medidas Size Dimensions	Euros
C-26	54 x 48	29,00

Lista oficial ternera

Veal official list

Officiel veau

Ref.	Medidas Size Dimensions	Euros
C-27	57 x 35	29,00

Lista oficial cordero

Lamb official list

Officiel agneau

Ref.	Medidas Size Dimensions	Euros
C-28	57 x 35	29,00



Cartel listas especiales Superior a 12 x 16 precio cm2, incluido números, fotos y textos.

Special lists tag
Top a 12 x 16 precio cm2, including numbers photos and text.

Cartel listes spéciales
Affiche 12 x 16 cm2 de prix, y compris les numéros, les photos et les textes.

Ref.	Euros
C-57	0,04

Material: Glaspar, Números recambiables
 Material: Glaspar, Numbers changeable
 Matériel: Glaspar, Chiffres interchangeable



Jamones

Ham

Jambon

Ref.	Medidas Size Dimensions	Euros
C-30	40 x 30	26,00



Paletas

Shoulder

Épaule

Ref.	Medidas Size Dimensions	Euros
C-30-P	40 x 30	26,00



Pollos

Chicken

Poulet

Ref.	Medidas Size Dimensions	Euros
C-32	40 x 30	26,00



Gallinas

Hen

Poule

Ref.	Medidas Size Dimensions	Euros
C-33	40 x 30	26,00



Conejos

Rabbit

Lapin

Ref.	Medidas Size Dimensions	Euros
C-31	40 x 30	26,00

CARTELES DESPIECE | CUT TAGS | AFFICHES DÉCOUPE

Material: Glaspar
 Material: Glaspar
 Matériel: Glaspar



Despiece porcino

Pork quartering

Dépeçage porcin

Ref.	Medidas Size Dimensions	Euros
C-62	60 x 50	20,00

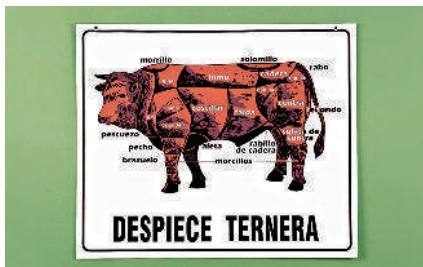

Despiece ternera

Veal quartering

Dépeçage veau

Ref.	Medidas Size Dimensions	Euros
C-63	60 x 50	20,00



Despiece cordero

Lamb quartering

Dépeçage agneau

Ref.	Medidas Size Dimensions	Euros
C-64	60 x 50	20,00



Señoras

Ladies

Dames

Ref.	Diámetro Diameter Diamètre	Euros
CI-1	Ø 7,5	3,25



Caballeros

Men

Messieurs

Ref.	Diámetro Diameter Diamètre	Euros
CI-2	Ø 7,5	3,25



Señoras/caballeros

Ladies/men

Dames/messieurs

Ref.	Diámetro Diameter Diamètre	Euros
CI-3	Ø 7,5	3,25



Minusválidos

Disabled

Personnes handicapées

Ref.	Diámetro Diameter Diamètre	Euros
CI-4	Ø 7,5	3,25



Zona de fumadores

Smoking area

espace fumeurs

Ref.	Diámetro Diameter Diamètre	Euros
CI-5	Ø 7,5	3,25



Prohibido fumar

non-smoking

interdiction fumeurs

Ref.	Diámetro Diameter Diamètre	Euros
CI-6	Ø 7,5	3,25



Zona fumadores

Smoking area

Espace fumeurs

Ref.	Diámetro Diameter Diamètre	Euros
CI-7	Ø 16	8,00



Prohibido fumar

Non-smoking

Interdiction de fumer

Ref.	Diámetro Diameter Diamètre	Euros
CI-8	Ø 16	8,00



Zona de fumadores

Smoking area

Espace fumeurs

Ref.	Medidas Size Dimensions	Euros
CI-9	20 x 8	12,00



Prohibido fumar

Non-smoking

Interdiction de fumer

Ref.	Medidas Size Dimensions	Euros
CI-10	20 x 8	12,00

Triángulo dos caras "Peligro suelo mojado". Material ABS amarillo. 62x30 cm

Triangle two faces "Danger wet ground". Yellow ABS material. 62x30 cm

Triangle deux faces "Danger sol humide". Matériau ABS jaune. 62x30 cm

Ref.	Euros
C-500	18,00





Guirnalda perejil

Parsley

Persil

Ref.	Largo Long Longueur	Euros
X-2500	270 cm	18,00



Hiedra

Ivy

Lierre

Ref.	Largo Long Longueur	Euros
X-2503	270 cm	24,00



Flor de viña

Vine flowers

Fleur de vigne

Ref.	Largo Long Longueur	Euros
X-2504	270 cm	25,00



Rosas rosas

Pink roses

Roses roses

Ref.	Largo Long Longueur	Euros
X-2505	180 cm	17,00



Navidad

Christmas

Noël

Ref.	Largo Long Longueur	Euros
X-2514	180 cm	26,00



Guirnalda tomates

Tomatoes

Tomates

Ref.	Largo Long Longueur	Euros
X-2800	200 cm	29,00



Guirnalda limones

Lemons

Citrons

Ref.	Largo Long Longueur	Euros
X-2801	180 cm	29,00



Guirnalda fresas

Strawberries

Fraises

Ref.	Largo Long Longueur	Euros
X-2802	200 cm	25,00



Guirnalda naranjas

Oranges

Oranges

Ref.	Largo Long Longueur	Euros
X-2803	200 cm	27,00



Guirnalda manzanas

Apples

Pommes

Ref.	Largo Long Longueur	Euros
X-2804	200 cm	27,00



Guirnalda viña verde

Green vine

Vigne vert

Ref.	Largo Long Longueur	Euros
X-2509	180 cm	19,00

**Hoja helecho silvestre**

Wild fern leaf

Feuille fougère silvestre

Ref.	Unidades Units Unités	Euros
X-2520	10	5,50

**Hoja lechuga**

Lettuce leaf

Feuille Laitue

Ref.	Unidades Units Unités	Euros
X-2530	12	19,00

**Hoja helecho**

Fern leaf

Feuille fougère

Ref.	Unidades Units Unités	Euros
X-2515	10	7,50

SEPARADORES | SEPARATORS | SÉPARATEURS

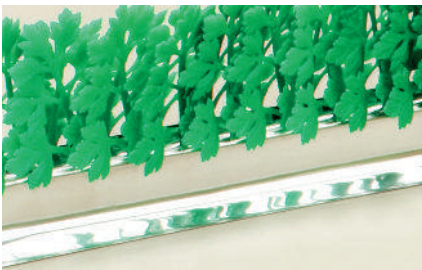
**Separador Perejil base inox**

Separator Parsley stainless steel base 25 cm

Séparateur Persil base acier inox. 24 cm

Ref.	Largo Long Longueur	Unidades Units Unités	Euros
A-1	25 cm	1	12,50

**Separador Perejil**

Separator Parsley

Séparateur Persil

Ref.	Largo Long Longueur	Unidades Units Unités	Euros
X-0024	24 cm	12	62,00

**Separador rosa roja**

Separator red rose

Séparateur roses rouges

Ref.	Largo Long Longueur	Unidades Units Unités	Euros
X-0724	24 cm	12	64,00





Separador Ciprés verde, base 9,5 x 75

Separator Green cypress, base 9,5 x 75

Séparateur Cyprés vert, base 9,5 x 75

Ref.	Euros
X-0100	25,00



Separador Verde-rojo, base 9,5 x 75

Separator Green-red, base 9,5 x 75

Séparateur Vert-rouge base 9,5 x 75

Ref.	Euros
X-0101	25,00



Separador Perejil, base 9,5 x 75

Separator Parsley, base 9,5 x 75

Séparateur Persil, base 9,5 x 75

Ref.	Euros
X-0102	28,00

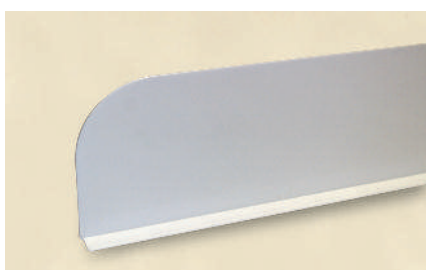

Separador Blanco 15 x 75

Separator White 15 x 75

Séparateur Blanc 15 x 75

Ref.	Euros
X-0200	20,00



Separador Verde 15 x 75

Separator Green 15 x 75

Séparateur Vert 15 x 75

Ref.	Euros
X-0201	21,00

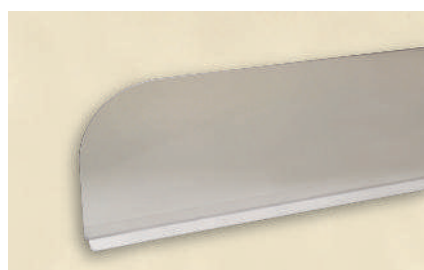

Separador Transparente 15 x 75

Separator Transparent 15 x 75

Séparateur Transparent 15 x 75

Ref.	Euros
X-0202	21,00



Separador Rojo 15 x 75

Separator Red 15 x 75

Séparateur Rouge 15 x 75

Ref.	Euros
X-0203	21,00



Separador Negro 15 x 75

Separator Black 15 x 75

Séparateur Noir 15 x 75

Ref.	Euros
X-0204	21,00

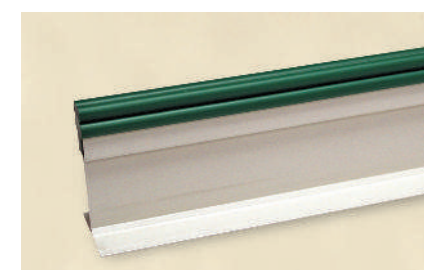

Separador Blanco con adorno verde 7 x 75

Separator White with green decoration 7 x 75

Séparateur Blanc avec ornement vert 7 x 75

Ref.	Euros
X-0210	17,00

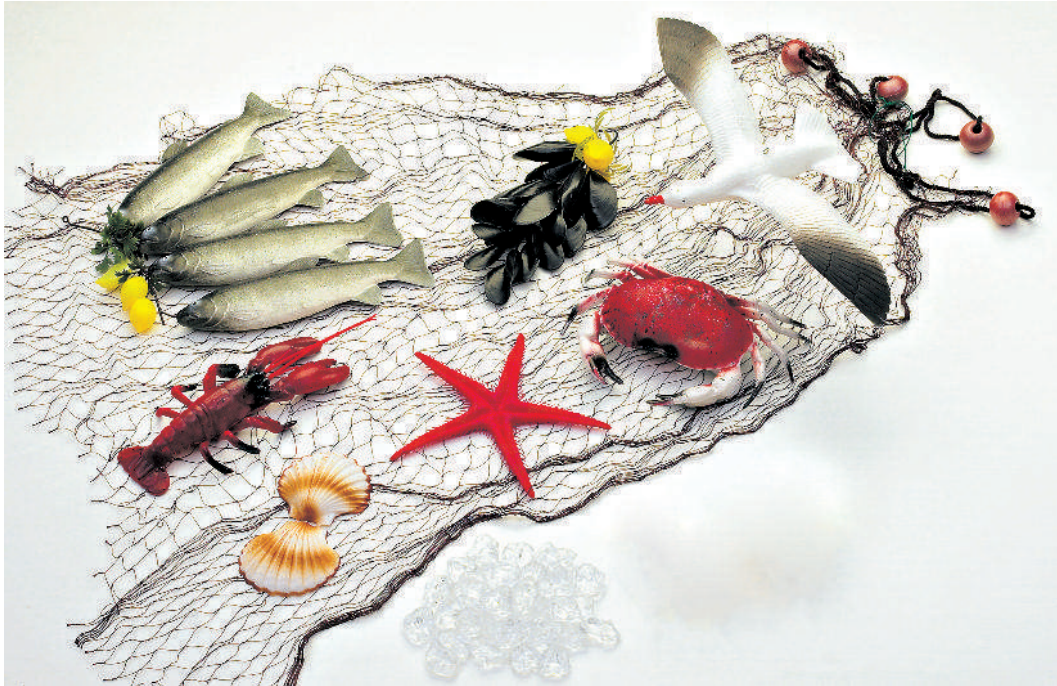
Mejillones con limones

Mussels and lemons

Mouelts et citrons

Ref.	Euros
X-2900	22,00

Gaviota

Seagull

Gavotte

Ref.	Euros
X-2903	26,00

Conchas 4 unidades

Shells 4 units

Coquillages 4 unités

Ref.	Euros
X-2906	15,40

Bogavante

Lobster

Homar

Ref.	Euros
X-2901	13,00

Truchas

Trouts

Trites

Ref.	Euros
X-2904	35,00

Bolsa con hielo

Ice bag

Sachet avec glaçons

Ref.	Euros
X-2907	19,10

Cangrejo de mar

Crab

Crabe

Ref.	Euros
X-2902	24,00

Estrella de mar - 2 unid.

Starfish - 2 units

Étoile de mer - 2 unités

Ref.	Euros
X-2905	12,00

Red de pesca

Fishing net

Filet de pêche

Ref.	Medidas Size Dimensions	Euros
X-2909	200 x 150 cm	14,00

Separador

Divider

Séparation

Ref.	Medidas Size Dimensions	Euros
X-9005	600 x 200	45,00
X-6886	800 x 200	57,00

Jamón

Ham

Jambon

Ref.	Euros
X-2910	49,00



CH12-18 - Barreño industrial sin tap

CH12-18 - Industrial tub no lid

CH12-18 - Bassine industriel sans couvercle

Ref.	Medidas Size Dimensions	Capacidad Capacity Capacité	Euros
CH-12	35 x 19 cm	12 l	10,00
CH-18	39 x 21 cm	18 l	13,00

Barreño industrial con tapa

Industrial tub with lid

Bassine industriel avec couvercle

Ref.	Medidas Size Dimensions	Capacidad Capacity Capacité	Euros
CH-30	49 x 26 cm	30 l	26,50
CH-40	49 x 37 cm	40 l	31,00
CH-50	49 x 45 cm	50 l	33,00
CH-75	50 x 60 cm	75 l	59,00
CH-100	54 x 69 cm	100 l	78,00

Cubo con medidor 30x29, asa inox., 13L.

Bin with measure 30x29, stainless steel handle, 13L.

Seau avec mesureur 30x29, anse inox, 13L

Ref.	Medidas Size Dimensions	Capacidad Capacity Capacité	Euros
CH-10	30 x 29 cm	13 l	13,00

CUBETA, BASE RODANTE | CONTAINER, ROLLING BASE | BAC, BASE ROULANTE



Cubeta azul pescadería

Blue box fishmonger's

Basin bleu poissonnerie

Ref.	Medidas Size Dimensions	Euros
CC-14	60 x 40 x 12,5 cm	14,00



**Cubeta encajable con tapa integrada azul
Medidas base 50,8 x 33,8**

Blue container stackable with lid
Base measures 50,8 x 33,8

Bac bleu encastrable avec couvercle
Dimensions de base 50,8 x 33,8

Ref.	Medidas Size Dimensions	Euros
CC-32	60 x 40 x 32 cm	28,00

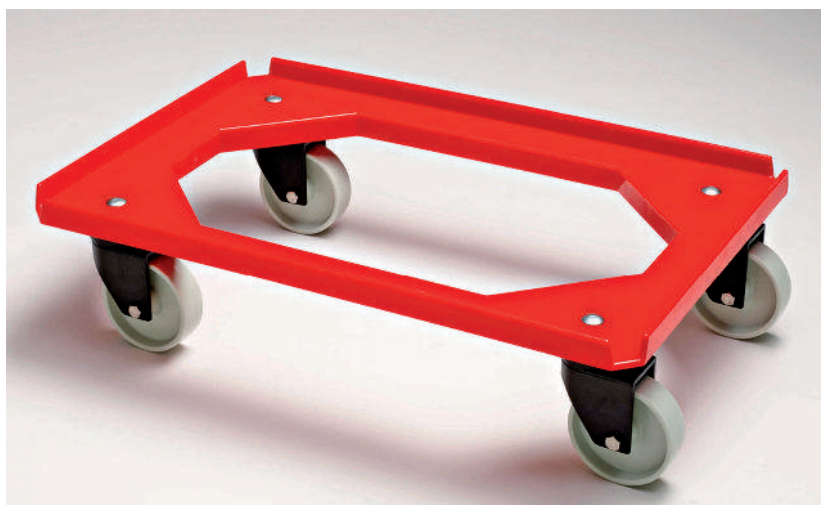

Base rodante para cubetas con 4 ruedas giratorias de poliamida.

Rolling base with 4 nylon wheels with natural rubber

Base roulante avec 4 roues giratoires en nylon et caoutchouc naturel.

Ref.	Medidas Size Dimensions	Euros
R-40	60 x 40 cm	94,00



Cubeta encajables

Container stackable

Bac encastrable

Ref.	Medidas Size Dimensions	Capacidad Capacity Capacité	Euros
CH-1	26 x 26 x 16 cm	6 l	5,50
CH-2	30 x 30 x 18 cm	10 l	7,50
CH-3	34 x 34 x 20 cm	14 l	10,00
CH-4	30 x 30 x 12 cm	7.5 l	6,50
CH-6	25 x 18 x 23 cm	8 l	5,50
CH-7	32 x 29 x 40 cm	26 l	13,00



Cubetas con asas apilable y encajable

Container with handles stackable

Bac empilable et encastrable

Ref.	Medidas Size Dimensions	Capacidad Capacity Capacité	Euros
CC-20	65 x 45 x 22,5 cm	20 l	32,00
CC-40	65 x 45 x 32 cm	40 l	38,00
CC-60	65 x 45 x 42,5 cm	60 l	50,00
CC-100	77 x 59,5 x 42,5 cm	100 l	62,00

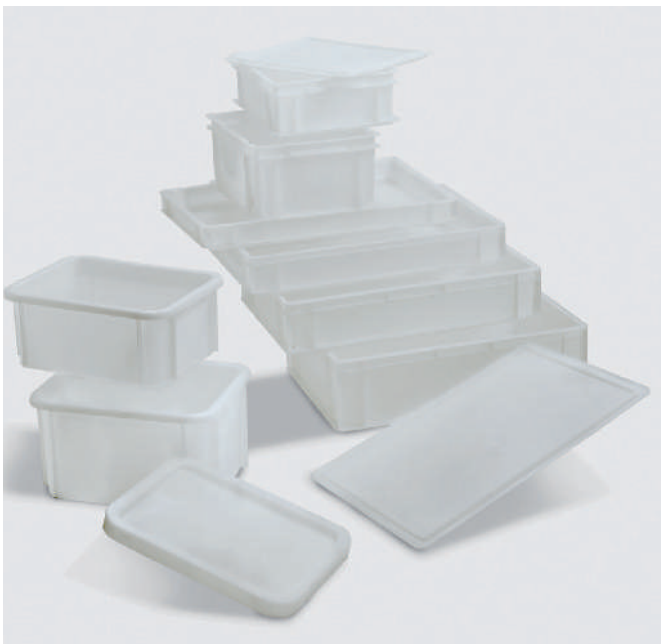

Cubeta apilables

Container stackable

Bac empilable

Ref.	Medidas Size Dimensions	Capacidad Capacity Capacité	Euros
CC-9	60 x 40 x 5,5 cm	9 l	12,00
CC-10	40 x 30 x 11,8 cm	11 l	11,00
CC-12	39,5 x 29,5 x 16 cm	12 l	15,00
CC-15	40 x 30 x 17,5 cm	16 l	13,00
CC-16	39,5 x 29,5 x 21,5 cm	15 l	17,00
CC-19	60 x 40 x 9 cm	19 l	13,00
CC-21	60 x 40 x 11,8 cm	21 l	17,00
CC-33	60 x 40 x 17	33 l	18,00

Tapa

Lid

Couvercle

Ref.	Medidas Size Dimensions	Euros
CCT-39	39,5 x 29,5 cm	8,00
CCT-40	40 x 30 cm	5,00
CCT-60	60 x 40 cm	12,00



Honda

Deep

Creux

Ref.	Medidas Size Dimensions	Euros
BX-4	33 x 23 x 2,5 cm	20,50
BX-5	40 x 30 x 2,5 cm	28,00
BX-6	51 x 35 x 2,5 cm	36,00
BX-9	36 x 27 x 2,5 cm	24,00



Plana

Flat

Plat

Ref.	Medidas Size Dimensions	Euros
BXP-2	32 x 22 cm	20,50
BXP-3	39 x 29 cm	28,00
BXP-4	50 x 34,5 cm	36,00
BXP-5	35 x 26 cm	24,00

BANDEJAS METACRILATO NEGRA | BLACK METHACRYLATE TRAYS | PLATEAUX MÉTHACRYLATE NOIRS



Honda

Deep

Creux

Ref.	Medidas Size Dimensions	Euros
BZ-1	33 x 23 x 2,5 cm	17,00
BZ-2	36 x 27 x 2,5 cm	21,00
BZ-3	40 x 30 x 2,5 cm	23,00
BZ-4	51 x 35,5 x 2,5 cm	30,00
BZ-5	30,5 x 16 x 2,5 cm	15,00
BZ-6	46 x 16,5 x 2,5 cm	17,50
BZ-10	58 x 38,5 x 2,5 cm	47,00



Plana

Flat

Plat

Ref.	Medidas Size Dimensions	Euros
BZP-1	32 x 22 cm	17,00
BZP-2	35 x 26 cm	21,00
BZP-3	39 x 29 cm	23,00
BZP-4	50 x 34,5 cm	30,00





Honda

Deep

Creux

Ref.	Medidas Size Dimensions	Euros
BB-1	30,5 x 16 x 2,5 cm	12,00
BB-2	16,5 x 46 x 2,5 cm	14,00
BB-3	20 x 27 x 2,5 cm	13,50
BB-4	23 x 33 x 2,5 cm	15,00
BB-5	30 x 40 x 2,5 cm	20,50
BB-6	51 x 35,5 x 2,5 cm	27,00
BB-9	36 x 27 x 2,5 cm	18,50
BB-10	58 x 38,5 x 2,5 cm	44,00

Plana

Flat

Plat

Ref.	Medidas Size Dimensions	Euros
BBP-1	26 x 19 cm	13,50
BBP-2	22 x 32 cm	15,00
BBP-3	29 x 39 cm	20,50
BBP-4	50 x 34,5 cm	27,00
BBP-5	35 x 26 cm	18,50

Redonda

Round

Rond

Ref.	Diámetro Diameter Diamètre	Euros
BB-8	Ø 24,5 cm	12,50

Cubetita

Container

Petit bac

Ref.	Medidas Size Dimensions	Euros
BB-7	35,5 x 23,5 x 3,5 cm	15,50

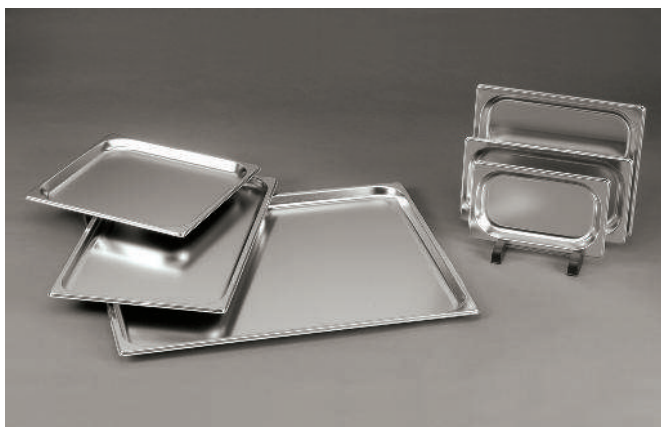

Bandejas acero-inox

Stainless Steel trays

Plateaux acier-inox

Ref.	Tipo Type Type	Medidas Size Dimensions	Euros
GI-2/1-20	2/1	65 x 53 x 2 cm	44,00
GI-1/1-20	1/1	53 x 32,5 x 2 cm	19,00
GI-2/4-20	2/4	53 x 16,5 x 2 cm	15,00
GI-2/3-20	2/3	35,5 x 32,5 x 2 cm	15,00
GI-1/2-20	1/2	32,5 x 26,5 x 2 cm	11,00
GI-1/3-20	1/3	32,5 x 17,5 x 2 cm	10,50
GI-1/4-20	1/4	26,4 x 16,2 x 2 cm	10,00



Bandeja autoservicio 3 compartimentos acero inox

Self-service tray
3 compartments stainless steel

Plateau self-service
3 compartiments acier inox

Ref.	Diámetro Diameter Diamètre	Euros
BA-3	Ø 28 cm	19,00



Bandeja autoservicio

Self-service tray

Plateau self-service

Ref.	Medidas Size Dimensions	Euros
BA-5	34,5 x 34,5 x 3,5 cm	26,00



Bandejas Pasteleras Acero Inox. / Aluminio

Stainless steel / aluminum pastry trays

Ref.	Medidas Size Dimensions	Euros
BAC-1	60 x 40 x 1 cm	33,00
BAL-1	60 x 40 x 1 cm	27,00



Cubetas por inyección-s

S injection trays

Bacs par injection-s

Ref.	Medidas Size Dimensions	Capacidad Capacity Capacité	Euros
BC-0	30 x 20 x 6 cm	2 l	3,50
BC-1	34 x 23 x 7 cm	3 l	4,00
BC-2	43 x 28 x 7,5 cm	5 l	6,00
BC-3	48 x 33 x 7,8 cm	8 l	7,50
BC-4	54 x 38 x 8,3 cm	10 l	9,50
BC-5	60 x 40 x 9 cm	15 l	10,50

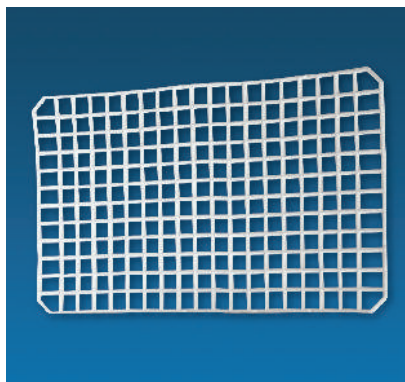

Rejillas para cubetas

Tray grille

Grille pour bac

Ref.	Medidas Size Dimensions	Euros
BCR-5	39,5 x 24,7 cm	6,20

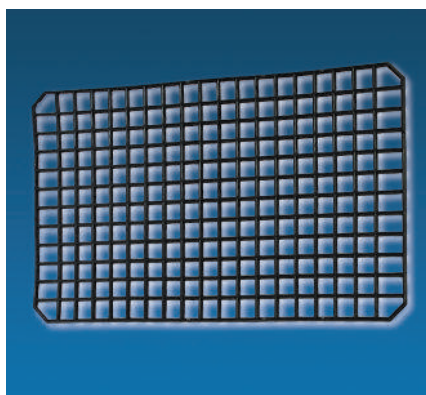

Rejilla para cubetas negras

Black tray grille

Grille pour bac noir

Ref.	Medidas Size Dimensions	Euros
BCR-5-N	39,5 x 24,7 cm	6,20



Cubetas por inyección-s negras

Injection-s containers black

Bacs par injection-s noir

Ref.	Medidas Size Dimensions	Capacidad Capacity Capacité	Euros
BC-0-N	30 x 20 x 6 cm	2 l	3,50
BC-1-N	34 x 23 x 7 cm	3 l	4,00
BC-2-N	43 x 28 x 7,5 cm	5 l	6,00
BC-3-N	48 x 33 x 7,8 cm	8 l	7,50
BC-4-N	54 x 38 x 8,3 cm	10 l	9,50



Bandejas por inyección alta presión

High pressure injection trays

Plateaux par injection haute pression

Ref.	Medidas Size Dimensions	Euros
BI-11	29 x 20 x 2 cm	6,20
BI-12	33 x 22,5 x 2 cm	7,30
BI-13	40 x 29 x 2 cm	9,15
BI-14	60 x 40 x 2 cm	16,00



Bandejas ABS para carros R-10/R-20

ABS tray

Plateaux à pâtisserie en acier inoxydable / aluminium

Ref.	Medidas Size Dimensions	Color Colour Couleur	Euros
BI-15-B	58,5 x 41 x 2,5 cm	○	15,00
BI-15-N	58,5 x 41 x 2,5 cm	●	16,00
BI-15-R	58,5 x 41 x 2,5 cm	●	16,00

BANDEJAS POR INYECCIÓN BAJA PRESIÓN | LOW PRESSURE INJECTION TRAYS | PLATEAUX PAR INJECTION BASSE PRESSION



Bandejas por inyección baja presión

Low pressure injection trays

Plateaux par injection basse pression

Ref.	Medidas Size Dimensions	Euros
BI-21	29 x 20 x 2 cm	3,50
BI-22	33 x 22,5 x 2 cm	4,00
BI-23	40 x 29 x 2 cm	6,00



Bandejas por inyección presión negra

Low pressure injection trays black

Plateaux par injection basse pression noir

Ref.	Medidas Size Dimensions	Euros
BI-21-N	29 x 20 x 2 cm	3,50
BI-22-N	33 x 22,5 x 2 cm	4,00
BI-23-N	40 x 29 x 2 cm	6,00

Cubetas gastronorm policarbonato

Gastronorm polycarbonate containers

Bacs gastronorm polycarbonate



Ref.	Tipo Type Type	Medidas Size Dimensions		Euros
GP-2/1-200	2/1	65 x 53 x 20 cm		57,00
GP-1/1-65	1/1	53 x 32,5 x 6,5 cm		15,00
GP-1/1-100	1/1	53 x 32,5 x 10 cm		17,00
GP-1/1-150	1/1	53 x 32,5 x 15 cm		21,00
GP-1/1-200	1/1	53 x 32,5 x 20 cm		26,50
GP-1/2-65	1/2	32,5 x 26,5 x 6,5 cm		7,50
GP-1/2-100	1/2	32,5 x 26,5 x 10 cm		8,50
GP-1/2-150	1/2	32,5 x 26,5 x 15 cm		11,50
GP-1/2-200	1/2	32,5 x 26,5 x 20 cm		12,00
GP-1/3-65	1/3	32,5 x 17,5 x 6,5 cm		5,50
GP-1/3-100	1/3	32,5 x 17,5 x 10 cm		6,50
GP-1/3-150	1/3	32,5 x 17,5 x 15 cm		9,00
GP-1/3-200	1/3	32,5 x 17,5 x 20 cm		12,00
GP-1/4-65	1/4	26,4 x 16,2 x 6,5 cm		5,00
GP-1/4-100	1/4	26,4 x 16,2 x 10 cm		5,50
GP-1/4-150	1/4	26,4 x 16,2 x 15 cm		7,00
GP-1/4-200	1/4	26,4 x 16,2 x 20 cm		7,50
GP-1/6-65	1/6	17,6 x 16,2 x 6,5 cm		4,00
GP-1/6-100	1/6	17,6 x 16,2 x 10 cm		4,50
GP-1/6-150	1/6	17,6 x 16,2 x 15 cm		5,50
GP-1/6-200	1/6	17,6 x 16,2 x 20 cm		7,00
GP-1/9-65	1/9	17,6 x 10,8 x 6,5 cm		3,00
GP-1/9-100	1/9	17,6 x 10,8 x 10 cm		3,50

Tapas policarbonato

Polycarbonate lids

Couvercles polycarbonate

Ref.	Tipo Type Type	Medidas Size Dimensions	Euros
GPT 1/1	1/1	53 x 32,5 cm	9,50
GPT 1/2	1/2	32,5 x 26,5 cm	5,50
GPT 1/3	1/3	32,5 x 17,5 cm	4,00
GPT 1/4	1/4	26,4 x 16,2 cm	3,50
GPT 1/6	1/6	17,6 x 16,2 cm	3,00
GPT 1/9	1/9	17,6 x 10,8 cm	2,50
GPT 2/1	2/1	65 x 53 cm	28,00

Doble fondo perforado policarbonato

Polycarbonate perforated double base

Double fond perforé polycarbonate

Ref.	Tipo Type Type	Medidas Size Dimensions	Euros
GPFP-1/1	1/1	46,5 x 26,5 cm	6,50
GPFP-1/2	1/2	26,5 x 20,5 cm	4,00
GPFP-2/1	2/1	56,5 x 44,5 cm	28,00

Cubetas gastronorm acero inoxidable

Stainless steel gastronorm containers

Bacs gastronorm acier inox



Ref.	Tipo Type Type	Medidas Size Dimensions		Euros
GI-2/1-20	2/1	65 x 53 x 2 cm		44,00
GI-2/1-40	2/1	65 x 53 x 4 cm		46,50
GI-2/1-65	2/1	65 x 53 x 6,5 cm		54,00
GI-2/1-100	2/1	65 x 53 x 10 cm		64,00
GI-2/1-150	2/1	65 x 53 x 15 cm		90,00
GI-2/1-200	2/1	65 x 53 x 20 cm		101,00
GI-1/1-20	1/1	53 x 32,5 x 2 cm		19,00
GI-1/1-40	1/1	53 x 32,5 x 4 cm		22,00
GI-1/1-65	1/1	53 x 32,5 x 6,5 cm		24,50
GI-1/1-100	1/1	53 x 32,5 x 10 cm		32,50
GI-1/1-150	1/1	53 x 32,5 x 15 cm		46,00
GI-1/1-200	1/1	53 x 32,5 x 20 cm		53,50
GI-2/3-20	2/3	35,5 x 32,5 x 2 cm		15,00
GI-2/3-40	2/3	35,5 x 32,5 x 4 cm		17,00
GI-2/3-65	2/3	35,5 x 32,5 x 6,5 cm		19,00
GI-2/3-100	2/3	35,5 x 32,5 x 10 cm		25,00
GI-2/3-150	2/3	35,5 x 32,5 x 15 cm		39,50
GI-2/3-200	2/3	35,5 x 32,5 x 20 cm		46,00
GI-1/2-20	1/2	32,5 x 26,5 x 2 cm		11,00
GI-1/2-40	1/2	32,5 x 26,5 x 4 cm		13,50
GI-1/2-65	1/2	32,5 x 26,5 x 6,5 cm		15,50
GI-1/2-100	1/2	32,5 x 26,5 x 10 cm		19,50
GI-1/2-150	1/2	32,5 x 26,5 x 15 cm		29,00
GI-1/2-200	1/2	32,5 x 26,5 x 20 cm		36,50
GI-1/3-20	1/3	32,5 x 17,5 x 2 cm		10,50
GI-1/3-40	1/3	32,5 x 17,5 x 4 cm		12,00
GI-1/3-65	1/3	32,5 x 17,5 x 6,5 cm		14,00
GI-1/3-100	1/3	32,5 x 17,5 x 10 cm		16,50
GI-1/3-150	1/3	32,5 x 17,5 x 15 cm		22,50
GI-1/3-200	1/3	32,5 x 17,5 x 20 cm		31,00
GI-1/4-20	1/4	26,4 x 16,2 x 2 cm		10,00
GI-1/4-40	1/4	26,4 x 16,2 x 4 cm		11,00
GI-1/4-65	1/4	26,4 x 16,2 x 6,5 cm		12,00
GI-1/4-100	1/4	26,4 x 16,2 x 10 cm		14,00
GI-1/4-150	1/4	26,4 x 16,2 x 15 cm		19,50
GI-1/4-200	1/4	26,4 x 16,2 x 20 cm		25,50



Ref.	Tipo Type	Medidas Size Dimensions	Euros
GI-1/6-65	1/6	17,6 x 16,2 x 6,5 cm	10,00
GI-1/6-100	1/6	17,6 x 16,2 x 10 cm	12,50
GI-1/6-150	1/6	17,6 x 16,2 x 15 cm	19,50
GI-1/6-200	1/6	17,6 x 16,2 x 20 cm	32,00
GI-1/9-65	1/9	17,6 x 10,8 x 6,5 cm	10,00
GI-1/9-100	1/9	17,6 x 10,8 x 10 cm	14,00

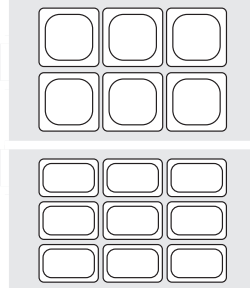

Cubetas gastronorm perforadas acero inoxidable

Stainless steel gastronorm perforated containers

Bacs gastronorm perforées acier inox



Ref.	Tipo Type	Medidas Size Dimensions	Euros
GIP-2/1-20	2/1	65 x 53 x 2 cm	64,00
GIP-2/1-40	2/1	65 x 53 x 4 cm	66,00
GIP-2/1-65	2/1	65 x 53 x 6,5 cm	73,00
GIP-1/1-20	1/1	53 x 32,5 x 2 cm	25,00
GIP-1/1-40	1/1	53 x 32,5 x 4 cm	27,00
GIP-1/1-65	1/1	53 x 32,5 x 6,5 cm	30,00
GIP-1/1-100	1/1	53 x 32,5 x 10 cm	49,00
GIP-1/1-150	1/1	53 x 32,5 x 15 cm	74,00
GIP-1/1-200	1/1	53 x 32,5 x 20 cm	90,00
GIP-1/2-65	1/2	32,5 x 26,5 x 6,5 cm	18,50
GIP-1/2-100	1/2	32,5 x 26,5 x 10 cm	28,50
GIP-1/2-150	1/2	32,5 x 26,5 x 15 cm	45,00
GIP-1/2-200	1/2	32,5 x 26,5 x 20 cm	55,00

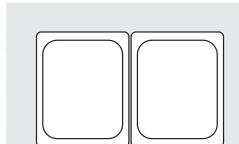
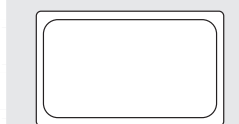
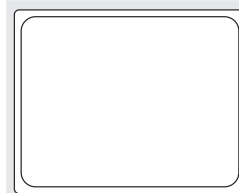

Tapas de cubierta gastronorm acero inox.

Lids for stainless steel gastronorm container

Couvercles de bac gastronorm acier inox.

Ref.	Tipo Type	Medidas Size Dimensions	Euros
GIT-1/1	1/1	53 x 32,5 cm	22,00
GIT-2/3	2/3	35,5 x 32,5 cm	15,50
GIT-1/2	1/2	32,5 x 26,5 cm	13,00
GIT-1/3	1/3	32,5 x 17,5 cm	10,50
GIT-1/4	1/4	26,4 x 16,2 cm	9,00
GIT-1/6	1/6	17,6 x 16,2 cm	7,50
GIT-1/9	1/9	17,6 x 10,8 cm	5,50

Tapas acero inoxidable hermética

Stainless steel tight lids

Couvercles acier inoxydable hermétique

Ref.	Tipo Type	Medidas Size Dimensions	Euros
GITH-1/1	1/1	53 x 32,5 cm	68,00
GITH-2/3	2/3	35,5 x 32,5 cm	50,00
GITH-1/2	1/2	32,5 x 26,5 cm	48,00
GITH-1/3	1/3	32,5 x 17,5 cm	41,00
GITH-1/4	1/4	26,4 x 16,2 cm	33,00
GITH-1/6	1/6	17,6 x 16,2 cm	28,00

0 2 CUBETAS GASTRONORM ACERO INDOXIDABLE | STAINLESS STEEL GASTRONORM CONTAINERS | BACS GASTRONORM ACIER INOX

Doble fondo perforado acero inoxidable

Stainless steel double base perforated

Double fond perforé acier inox

Ref.	Tipo Type	Medidas Size Dimensions	Euros
GIFP-1/1	1/1	47 x 27 cm	23,00
GIFP-1/2	1/2	26,5 x 20,5 cm	15,50
GIFP-2/1	2/1	59 x 47 cm	39,50
GIFP-2/3	2/3	29,5 x 26,5 cm	18,00

Separadores acero inoxidable

Stainless steel separators

Séparateurs acier inoxydable

Ref.	Tipo Type	Medidas Size Dimensions	Euros
GIS-325	1/2	32,5 x 2 cm	3,00
GIS-530	1/1	53 x 2 cm	4,00

CUBETAS GASTRONORM PLEXILINE | PLEXILINE GASTRONORM CONTAINERS | BACS GASTRONORM PLEXILINE

System gastronorm, negro

System gastronorm, black

System gastronorm, noir



Ref.	Tipo Type	Medidas Size Dimensions	Euros
BP-GN-1/1-17-N	1/1	53 x 32,5 x 1,7 cm	48,00
BP-GN 1/1-50-N	1/1	53 x 32,5 x 5 cm	55,00
BP-GN-1/2-17-N	1/2	32,5 x 26,5 x 1,7 cm	20,00
BP-GN 1/2-50-N	1/2	32,5 x 26,5 x 5 cm	28,00
BP-GN 1/3-17-N	1/3	32,5 x 17,6 x 1,7 cm	15,00
BP-GN 1/3-50-N	1/3	32,5 x 17,6 x 5 cm	21,00
BP-GN 1/4-17-N	1/4	26,5 x 16,2 x 1,7 cm	13,00
BP-GN 1/4-50-N	1/4	26,5 x 16,2 x 5 cm	17,00
BP-GN 1/5-17-N	1/5	26,5 x 20 x 1,7 cm	14,00
BP-GN 1/5-50-N	1/5	26,5 x 20 x 5 cm	17,00
BP-GN 1/6-50-N	1/6	17,6 x 16,2 x 5 cm	15,00
BP-GN 1/9-50-N	1/9	17,6 x 10,8 x 5 cm	13,00
BP-GN 2/4-17-N	2/4	53 x 16,2 x 1,7 cm	26,00
BP-GN 2/5-17-N	2/5	53 x 20 x 1,7 cm	28,00
BP-GN 3/4-17-N	3/4	48,7 x 26,5 x 1,7 cm	30,00
BP-GN 3/4-50-N	3/4	48,7 x 26,5 x 5 cm	37,00
BP-GN 5/4-40-N	5/4	81 x 26,5 x 4 cm	67,00



Tapas transparente

Transparent lid

Couvercle transparent

Ref.	Tipo Type Type	Medidas Size Dimensions	Euros
BPT-1/1-T	1/1	53 x 32,5 cm	38,00
BPT-1/2-T	1/2	32,5 x 26,5 cm	24,00
BPT-1/3-T	1/3	32,5 x 17,6 cm	23,00
BPT-1/4-T	1/4	26,5 x 16,2 cm	17,00
BPT-1/5-T	1/5	26,5 x 20 cm	23,00
BPT-2/5-T	2/5	53 x 20 cm	31,00
BPT-3/4-T	3/4	48,7 x 26,5 cm	34,00



Rejillas negro

Black grid

Grille noir

Ref.	Tipo Type Type	Medidas Size Dimensions	Euros
BPR-1/1-N	1/1	53 x 32,5 cm	51,00
BPR-1/2-N	1/2	32,5 x 26,5 cm	26,00
BPR-1/3-N	1/3	32,5 x 17,6 x 8 cm	18,00
BPR-1/4-N	1/4	26,5 x 16,2 cm	17,00
BPR-1/5-N	1/5	26,5 x 20 cm	20,00



Triángulo

Triangle

Triangle

Ref.	Medidas Size Dimensions	Altura Height Hauteur	Euros
BPTR-27-20-N	27 x 27 x 37 cm	2 cm	18,00
BPTR-40-20-N	40 x 40 x 56,5 cm	2 cm	28,00
BPTR-40-50-N	40 x 40 x 56,5 cm	5 cm	32,00





9 Bandejas + escalera

9 trays + step

9 plateaux + escalier



Escalera anfiteatro

Step amphitheater

Escalier amphithéâtre

Ref.	Medidas Size Dimensions	Euros
BPA-ANFI	80 x 80 x 6,5 cm	315,00



x1

1/4 luna 90° negro

1/4 moon 90° black

1/4 lune 90° noir

Ref.	Medidas Size Dimensions	Euros
BPA-90-50-N	26,5 x 26,5 x 5 cm	30,00



x2

Esquina 45° negro

Corner 45° black

Coin 45° noir

Ref.	Tipo Type Type	Euros
BPA-45-50-N	39/22 x 26,5 x 5,0 cm	38,00



x4

Esquina 22,5° negro

Corner 22,5° black

Coin 22,5° noir

Ref.	Tipo Type Type	Euros
BPA-22G-50-N	30/21 x 26,0 x 5,0 cm	28,00



x1

Triángulo izquierdo negro

Left triangle black

Triangle gauche noir

Ref.	Tipo Type Type	Euros
BPA-TI-50-N	53 x 30 x 5,0 cm	35,00



x1

Triángulo derecho negro

Right triangle black

triangle droite noir

Ref.	Tipo Type Type	Euros
BPA-TD-50-N	53 x 30 x 5,0 cm	35,00

13 Bandejas + escalera

13 trays + step

13 plateaux + escalier

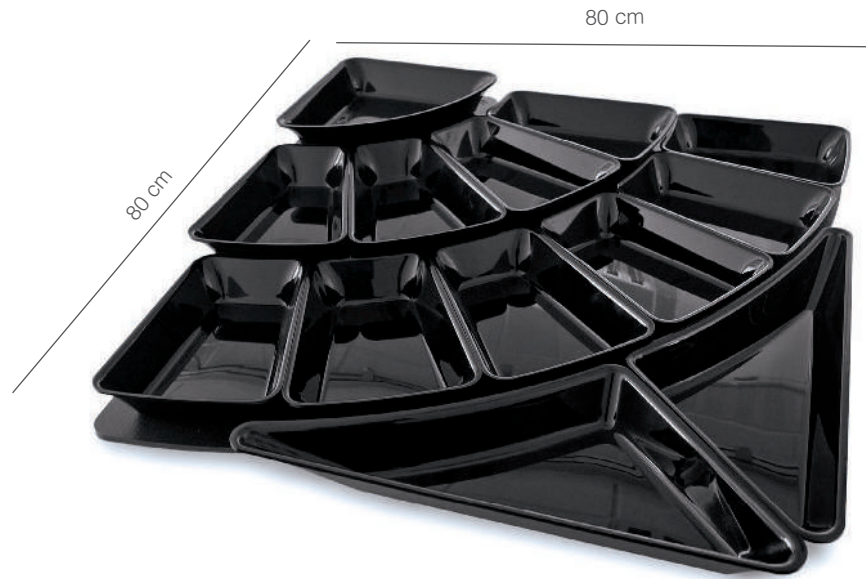

x1



x4

Escalera anfiteatro

Step amphitheater

Escalier amphithéâtre

Ref.	Medidas Size Dimensions	Euros
BPA-ANFI	80 x 80 x 6,5 cm	315,00

1/4 luna 90° negro

1/4 moon 90° black

1/4 lune 90° noir

Ref.	Medidas Size Dimensions	Euros
BPA-90-50-N	26,5 x 26,5 x 5 cm	30,00

Esquina 22,5° negro

Corner 22,5° black

Coin 22,5° noir

Ref.	Tipo Type Type	Euros
BPA-22P-50-N	20/11 x 26,5 x 5,0 cm	20,00



x6



x1



x1

Esquina 15° negro

Corner 15° black

Coin 15° noir

Ref.	Tipo Type Type	Euros
BPA-15-50-N	20/14 x 26,5 x 5,0 cm	18,00

Triángulo izquierdo negro

Left triangle black

Triangle gauche noir

Ref.	Tipo Type Type	Euros
BPA-TI-50-N	53 x 30 x 5,0 cm	35,00

Triángulo derecho negro

Right triangle black

triangle droite noir

Ref.	Tipo Type Type	Euros
BPA-TD-50-N	53 x 30 x 5,0 cm	35,00



Oval 420 x 270 mm H30

Oval 420 x 270 mm H30

Oval 420 x 270 mm H30

Ref.	Medidas Size Dimensions	Euros
BP-10063-N	42 x 27 x 3 cm	38,00



Octo 265 x 200 mm H50 GN1/5

Octo 265 x 200 mm H50 GN1/5

Octo 265 x 200 mm H50 GN1/5

Ref.	Medidas Size Dimensions	Euros
BP-6960-N	26,5 x 20 x 5 cm	21,00



Octo 265 x 325 mm H45 GN1/2

Octo 265 x 325 mm H45 GN1/2

Octo 265 x 325 mm H45 GN1/2

Ref.	Medidas Size Dimensions	Euros
BP-5355-N	26,5 x 32,5 x 4,5 cm	32,00



Oval 265 x 200 mm H 65 mm GN1/5

Oval 265 x 200 mm H 65 mm GN1/5

Oval 265 x 200 mm H 65 mm GN1/5

Ref.	Medidas Size Dimensions	Euros
BP-6665-N	26,5 x 20 x 6,5 cm	23,00



Oval 265 x 325 mm H 65 mm GN1/2

Oval 265 x 325 mm H 65 mm GN1/2

Oval 265 x 325 mm H 65 mm GN1/2

Ref.	Medidas Size Dimensions	Euros
BP-6661-N	26,5 x 32,5 x 6,5 cm	30,00



Redonda Ø 300 mm H 65 mm

Round Ø 300 mm H 65 mm

Round Ø 300 mm H 65 mm

Ref.	Altura Height Hauteur	Diámetro Diameter Diamètre	Euros
BP-6670-N	6,5 cm	Ø 30 cm	34,00



Redonda/Exa 175 mm H 80 mm 1,5l

Round/Hexa 175 mm H 80 mm 1,5l

Round/Hexa 175 mm H 80 mm 1,5l

Ref.	Altura Height Hauteur	Diámetro Diameter Diamètre	Euros
BP-4013-N	8 cm	Ø 17,5 cm	22,00



Redonda/Exa 215 mm H 80 mm 2,5l

Round/Hexa 215 mm H 80 mm 2,5l

Round/Hexa 215 mm H 80 mm 2,5l

Ref.	Altura Height Hauteur	Diámetro Diameter Diamètre	Euros
BP-6675-N	8 cm	Ø 21,5 cm	28,00

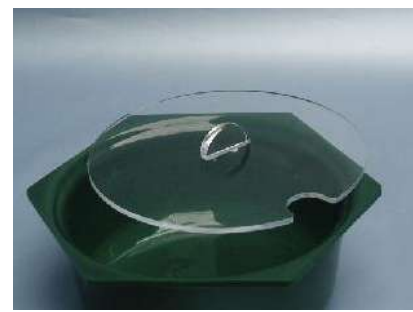

Tapa Plexiline redonda/hexa transparente

Plexiline lid round/hexa transparent

Couvercle plexiline roud/hexa transparent

Ref.	Diámetro Diameter Diamètre	Para For Pour	Euros
BPT-4015	Ø 175	Ref. BP-4013-N	8,00
BPT-6680	Ø 215	Ref. BP-6675-N	11,00



Base 8 x 1,5l Redonda/Exa. HIPS 800x400 mm H 80 mm. Para ref. BP-4013-N.

Holder 8 x 1,5l Round/Hex. HIPS 800x400 mm H 80 mm. For ref. BP-4013-N.

Holder 8 x 1,5l Rond/Hex. HIPS 800x400 mm H 80 mm. Pour ref. BP-4013-N.

Ref.	Medidas Size Dimensions	Euros
BPB-25140	80 x 40 x 8 cm	172,00



Cubeta concha 270x250 mm H 70 mm

Shell Shell 270x250 mm H 70 mm

Seau Coquille 270x250 mm H 70 mm

Ref.	Medidas Size Dimensions	Euros
BP-5356-N	27 x 25 x 7 cm	38,00



Cubeta Huevo 300x210 mm H 75 mm

Egg shelf 300x210 mm H 75 mm

Seau Oeuf 300x210 mm H 75 mm

Ref.	Medidas Size Dimensions	Euros
BP-5921-N	30 x 21 x 7,5 cm	33,00



Yin Yang 300 mm H 65 mm

Yin Yang 300 mm H 65 mm

Yin Yang 300 mm H 65 mm

Ref.	Altura Height Hauteur	Diámetro Diameter Diamètre	Euros
BP-5869-N	6,5 cm	Ø 30 cm	27,00



ACCESORIOS | ACCESSORIES | ACCESOIRES

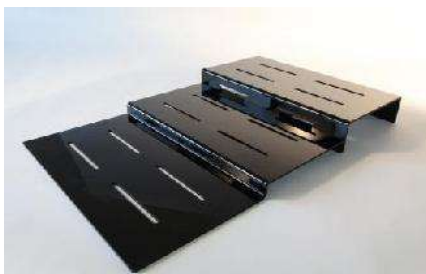

Escalón 3 niveles 500x800 mm H 80 mm

Step 3 levels 500x800 mm H 80 mm

Étape 3 niveaux 500x800 mm H 80 mm

Ref.	Medidas Size Dimensions	Euros
BPB-9232-N	500 x 800 x 80 mm	175,00

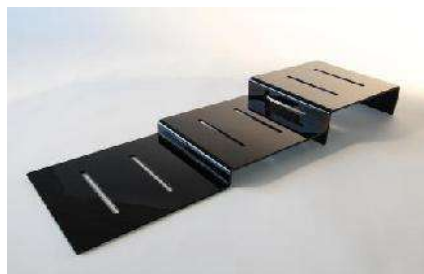

Escalón 3 niveles 250x800 mm H 80 mm

Step 3 levels 250x800 mm H 80 mm

Étape 3 niveaux 250x800 mm H 80 mm

Ref.	Medidas Size Dimensions	Euros
BPB-10569-N	250 x 800 x 80 mm	128,00



Escalón 1 nivel 624x280 mm H 75 mm

Step 1 level 624x280 mm H 75 mm

Étape 1 niveau 624x280 mm H 75 mm

Ref.	Medidas Size Dimensions	Euros
BPB-17068-N	624 x 280 x 75 mm	82,00



Escalón 1 nivel 624x280 mm H 35 mm

Step 1 level 624x280 mm H 35 mm

Étape 1 niveau 624x280 mm H 35 mm

Ref.	Medidas Size Dimensions	Euros
BPB-17069-N	624 x 280 x 35 mm	70,00



Escalón 1 nivel 312x280 mm H 75 mm

Step 1 level 312x280 mm H 75 mm

Étape 1 niveau 312x280 mm H 75 mm

Ref.	Medidas Size Dimensions	Euros
BPB-17071-N	312 x 280 x 75 mm	41,00



Escalón 1 nivel 312x280 mm H 35 mm

Step 1 level 312x280 mm H 35 mm

Étape 1 niveau 312x280 mm H 35 mm

Ref.	Medidas Size Dimensions	Euros
BPB-17070-N	312 x 280 x 35 mm	36,00



Pala de picar

Spoon minced

Pelle à hacher

Ref.	Largo Long Longueur	Euros
BP-1946-N	260 mm	9,50



Cuchara

Spoon

Cuillère

Ref.	Largo Long Longueur	Euros
BP-6901-N	240 mm	4,00



Cuchara perforadora

Perforated spoon

Cuillère perforée

Ref.	Largo Long Longueur	Euros
BP-14330-N	250 mm	5,00



Expositor de sandwich

Sandwich display

Porte Sandwich

Ref.	Medidas Size Dimensions	Euros
BP-9327-N	520 x 135 x 50 mm	33,00



Pinza plástica

Plastic salad clip

Pince en plastique

Ref.	Largo Long Longueur	Unidades Units Unités	Euros
C-215-N	80 mm	10	22,00
C-215-B	80 mm	10	22,00



Base giratoria 80 cm

Rotating base 80 cm

Base tournante 80 cm

Ref.	Altura Height Hauteur	Diámetro Diameter Diamètre	Euros
BPC-24544-N	5 mm	Ø 800 mm	380,00



x4

Triángulo

Triangle

Triangle

Ref.	Medidas Size Dimensions	Euros
BPC-22861-N	325 x 158 x 60 mm	21,00



x8

GN 1/5 265x265 mm

GN 1/5 265x265 mm

GN 1/5 265x265 mm

Ref.	Medidas Size Dimensions	Euros
BPC-22860-N	265 x 265 x 80 mm	27,00



x2

Ensaladera Redonda 2,5l

Round salad dish 2,5l

Assiette à salade ronde 2,5l

Ref.	Altura Height Hauteur	Diámetro Diameter Diamètre	Euros
BPC-22866-N	80 mm	Ø 225 mm	28,00





0

3

**Picadoras, Picadora refrigerada, Cuchillas
Placas, Empujadores picadoras, Cortadoras,
Ralladora, Exprimidor, Cortadora multifunción,
Enternecedor de carne, Cutters, Molino,
Afiladoras, Cintas de sierra**

Mincers, Refrigerated mincers, Blades plates,
Mincer pusher, Slicer, Grater, Juicer, Multi-
purpose slicer, Meat tenderizer, Cutters, Mill,
Sharpener, Band saws

*Hachoirs, Hachoirs refrigerés, Lames plaques,
Poussoir hachoirs, Trancheuse, Râpes, Presse,
Decoupoir multifonction, Attendrissant, Cutter,
Moulin, Aiguiseur, Scies à ruban.*

63 - 86

Picadora de carne

Boca 12. Cuerpo: acero inoxidable. Grupo picador: acero inoxidable. Cuchilla autoafilante. Interruptor: invertidor de marcha. Potencia 1 HP. Motor: trifásico 220/380 V. Producción: 120 kg/h

Meat mincer

Outlet: 12. Body: stainless steel. Mincer set: stainless steel. Self-sharpening blade. Reverse switch. Power 1 HP. Engine : three phase 220 / 380. Production 120 kg/h.

Hachoir à viande

Goulot: 12. Corps: acier inoxydable. Groupe hachoir: acier inoxydable. Couteau: auto aiguiser. Interrupteur: inverseur. Puissance: 1 HP. Moteur : triphase 220/380. Production: 120 kg.

Picadora de carne

Boca 12. Cuerpo acero inoxidable. Grupo picador: acero inoxidable. Cuchilla autoafilante. Interruptor: invertidor de marcha. Potencia: 1 HP. Motor: monofásico 220 V. Producción: 120 kg/h

Meat mincer

Outlet: 12. Body: stainless steel. Mincer set: stainless steel. Self-sharpening blade. Reverse switch. Power 1 HP. Engine: one phase 220. Production 120 kg/h.

Goulot: 12. Corps: acier inoxydable. Groupe hachoir: acier inoxydable. Couteau: auto aiguiser. Interrupteur: inverseur. Puissance: 1 HP. Moteur: monophasé 220. Production 120 kg.

Ref.	Peso Weight Poids	Euros
MP-12MEC-T	23 kg	945,00

Ref.	Peso Weight Poids	Euros
MP-12MEC-M	23 kg	975,00



Despiece / Quartering / Dépeçage

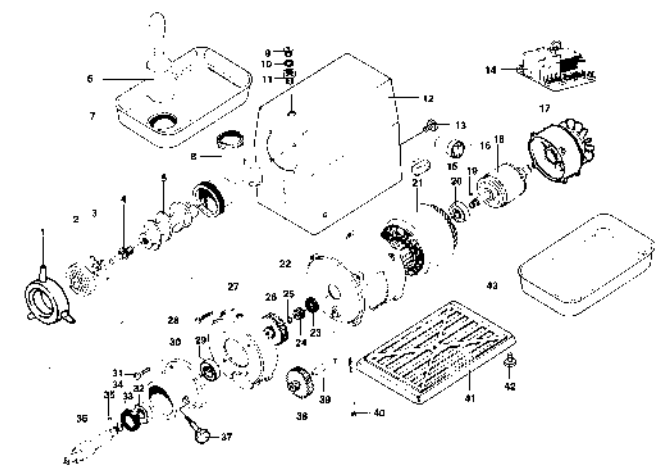

Medidas / Size / Dimensions

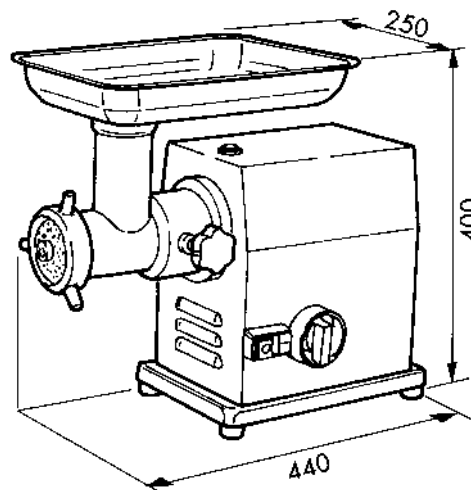

Picadora de carne

Boca: 22. Cuerpo: acero inoxidable. Grupo picador: acero inoxidable. Cuchilla: autoafilante. Interruptor: invertidor de marcha. Potencia. 1 HP. Motor: trifásico 220/380. Producción: 130 kg/h

Meat mincer

Outlet: 22. Body: stainless steel. Mincer set: stainless steel. Blade: self-sharpening. Switch: reverse switch. Power: 1 HP. Engine: three phase 220/380 V. Production: 130 Kg/h

Hachoirs à viande

Goulot: 22. Corps: acier inoxydable. Groupe hachoir: acier inoxydable. Couteau: auto aiguseur. Interrupteur: inverseur. Puissance 1 HP. Moteur: thiphasé 220/380 V. Production 130 kg/h

Picadora de carne

Boca: 22. Cuerpo: acero inoxidable. Grupo picador: acero inoxidable. Cuchilla: autoafilante. Interruptor: invertidor de marcha. Potencia. 1 HP. Motor: monofásico 220 V. Producción: 130 kg/h

Meat mincer

Outlet: 22. Body: stainless steel. Mincer set: stainless steel. Blade: self-sharpening. Switch: reverse switch. Power: 1 HP. Engine: one phase 220 V. Production: 130 Kg/h

Hachoirs à viande

Goulot: 22. Corps: acier inoxydable. Groupe hachoir: acier inoxydable. Couteau: auto aiguseur. Interrupteur: inverseur. Puissance 1 HP. Moteur: monophasé 220 V. Production 130 kg/h

Ref.	Peso Weight Poids	Euros
MP-22 EURO-T	23 kg	1215,00

Ref.	Peso Weight Poids	Euros
MP-22 EURO-M	23 kg	1255,00



Despiece / Quartering / Dépeçage

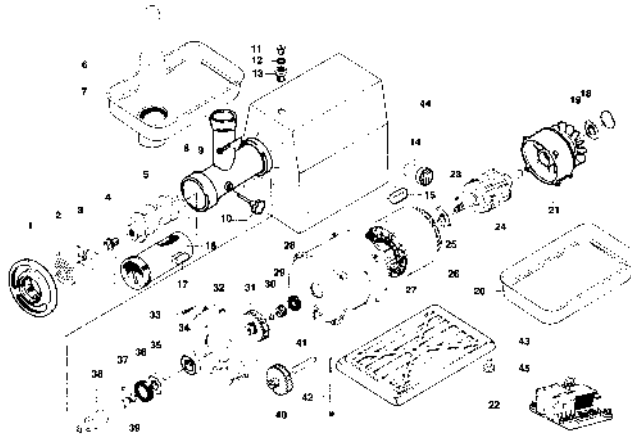

Medidas / Size / Dimensions

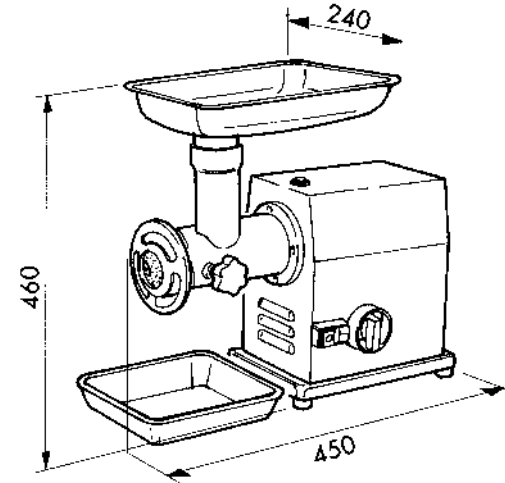

Picadora de carne

Boca: 22. Cuerpo: acero inoxidable. Grupo picador: acero inoxidable. Cuchilla: autoafilante. Interruptor: invertidor de marcha. Potencia: 1,5 HP. Motor: trifásico 220/380V. Producción 250 kg/h

Meat mincer

Outlet: 22. Body: stainless steel. Blade: self-sharpening. Switch: reverse switch. Power: 1,5 HP. Engine: triphase 220/380 V. Production: 250 kg/h.

Hachoirs à viande

Goulot 22. Corps: acier inoxydable. Groupe hachoir: acier inoxydable. Couteau: auto aiguteur. Interrupteur: inverseur. Puissance: 1,5 HP. Moteur: triphasé 220/380 V. Production: 250 kg/h

Picadora de carne

Boca: 22. Cuerpo: acero inoxidable. Grupo picador: acero inoxidable. Cuchilla: autoafilante. Interruptor: invertidor de marcha. Potencia: 1,5 HP. Motor: monofásico 220 V. Producción 250 kg/h

Meat mincer

Outlet: 22. Body: stainless steel. Blade: self-sharpening. Switch: reverse switch. Power: 1,5 HP. Engine: one phase 220 V. Production: 250 kg/h.

Hachoirs à viande

Goulot 22. Corps: acier inoxydable. Groupe hachoir: acier inoxydable. Couteau: auto aiguteur. Interrupteur: inverseur. Puissance: 1,5 HP. Moteur: monophasé 220 V. Production: 250 kg/h

Ref.	Peso Weight Poids	Euros
MP-22 MEC-T	30 kg	1445,00

Ref.	Peso Weight Poids	Euros
MP22 MEC-M	30 kg	1490,00



Despiece / Quartering / Dépeçage

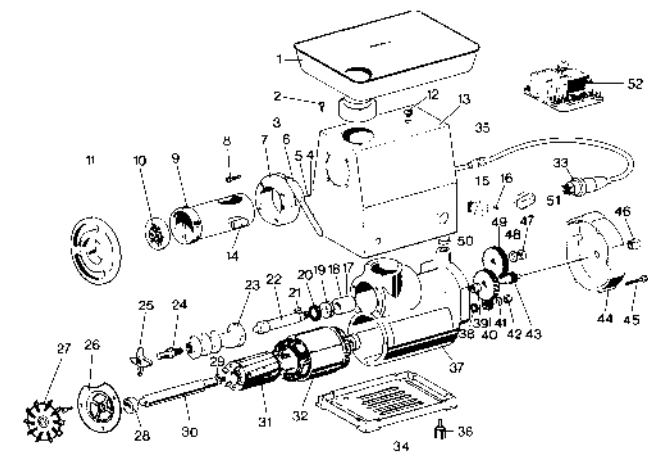

Medidas / Size / Dimensions

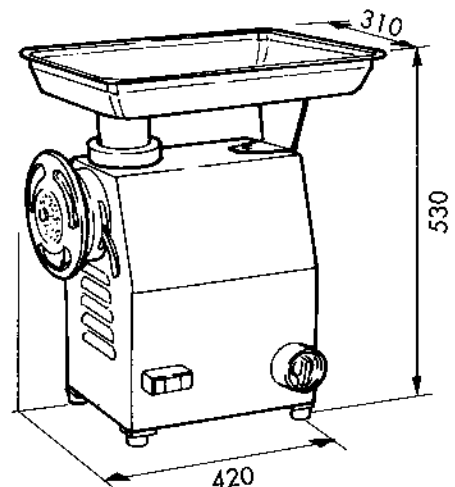

Picadora de carne

Boca: 32. Cuerpo: acero inoxidable. Grupo picador: acero inoxidable. Cuchilla: autoafilante. Interruptor: invertidor de marcha. Potencia 3 HP. Motor trifásico 220/380 V. Producción: 500 kg/h.

Meat mincer

Outlet: 32. Body: stainless steel. Mincer set: stainless steel. Blade: self-sharpening. Revers switch. Power: 3 HP. Engine: three phase 220/380 V. Production: 500 kg/h.

Hachoirs à viande

Goulot: 32. Corps: acier inoxydable. Groupe hachoir: acier inoxydable. Couteau: auto aiguiser. Interrupteur: inverseur. Puissance: 3 HP. Moteur: triphasé 220/380 V. Production: 500 kg

Picadora de carne

Boca: 32. Cuerpo: acero inoxidable. Grupo picador: acero inoxidable. Cuchilla: autoafilante. Interruptor: invertidor de marcha. Potencia 3 HP. Motor monofásico 220 V. Producción: 500 kg/h.

Meat mincer

Outlet: 32. Body: stainless steel. Mincer set: stainless steel. Blade: self-sharpening. Revers switch. Power: 3 HP. Engine: one phase 220 V. Production: 500 kg/h.

Hachoir à viande

Goulot: 32. Corps: acier inoxydable. Groupe hachoir: acier inoxydable. Couteau: auto aiguiser. Interrupteur: inverseur. Puissance: 3 HP. Moteur: monophasé 220 V. Production: 500 kg

Ref.	Peso Weight Poids	Euros
MP-32 MEC-T	47 kg	2190,00

Ref.	Peso Weight Poids	Euros
MP-32 MEC-M	47 kg	2255,00



Despiece / Quartering / Dépeçage

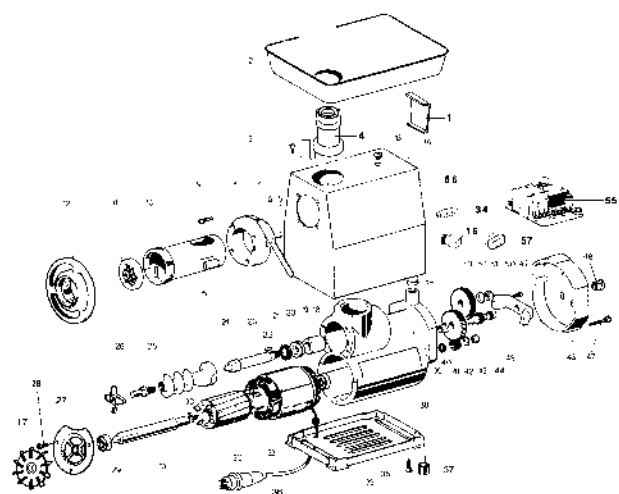

Medidas / Size / Dimensions

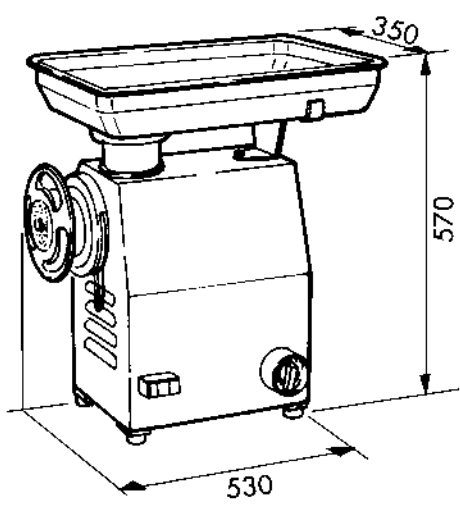

Picadora refrigerada

Boca: 22. Cuerpo: acero inoxidable. Grupo picador: acero inoxidable. Cuchilla: autoafilante. Interruptor: invertidor de marcha. Potencia 1,5 HP. Grupo refrigerador hermético ventilado. Motor trifásico 220/380 V. Peso: 58 kg. Producción: 200 kg/h.

Refrigerated mincer

Outlet: 22. Body: stainless steel. Mincer set: stainless steel. Blade: self-sharpening. Switch: reverse switch. Power: 1,5 HP. Veintilated hermetic refrigeration motor. Motor: three phase 220/380 V. Weight: 58 kg. Production: 200 kg.

Hachoir réfrigéré

Goulot: 22. Corps: acier inoxydable. Couteau: auto aiguiser. Interrupteur: inverseur. Puissance: 1,5 HP. Groupe réfrigérateur hermétique ventilé. Moteur triphasé 220/380 V. Poids: 58 kg. Production: 200 kg/h

Picadora refrigerada

Boca: 22. Cuerpo: acero inoxidable. Grupo picador: acero inoxidable. Cuchilla: autoafilante. Interruptor: invertidor de marcha. Potencia 1,5 HP. Grupo refrigerador hermético ventilado. Motor monofásico 220 V. Peso: 58 kg. Producción: 200 kg/h.

Refrigerated mincer

Outlet: 22. Body: stainless steel. Mincer set: stainless steel. Blade: self-sharpening. Switch: reverse switch. Power: 1,5 HP. Veintilated hermetic refrigeration motor. Motor: one phase 220 V. Weight: 58 kg. Production: 200 kg.

Hachoir réfrigéré

Goulot: 22. Corps: acier inoxydable. Couteau: auto aiguiser. Interrupteur: inverseur. Puissance: 1,5 HP. Groupe réfrigérateur hermétique ventilé. Moteur monophasé 220 V. Poids: 58 kg. Production: 200 kg/h

Ref.	Euros
MP-22RE-T	3500,00

Ref.	Euros
MP-22RE-M	3550,00



Despiece / Quartering / Dépeçage

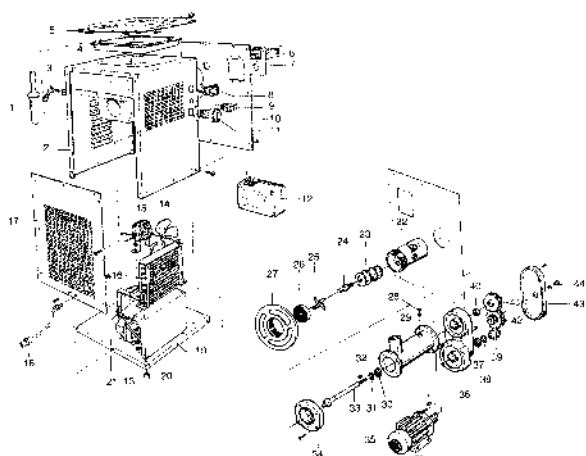

Medidas / Size / Dimensions

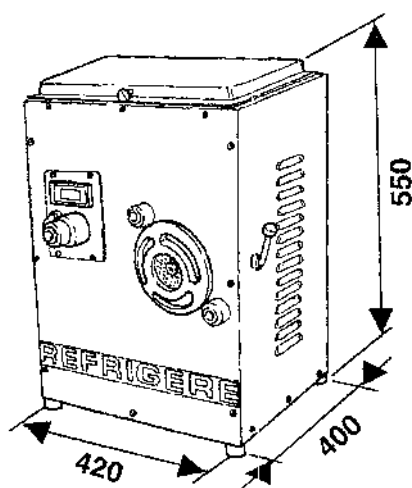

Picadora refrigerada

Boca: 22. Cuerpo: acero inoxidable. Grupo picador: acero inoxidable. Cuchilla: autoafilante. Interruptor: invertidor de marcha. Potencia 3 HP. Grupo refrigerador hermético ventilado. Motor trifásico 220/380 V. Peso: 80 kg. Producción: 300 kg/h.

Refrigerated mincer

Outlet: 22. Body: stainless steel. Mincer set: stainless steel. Blade: self-sharpening. Switch: reverse switch. Power: 3 HP. Veintilated hermetic refrigeration motor. Motor: three phase 220/380 V. Weight: 80 kg. Production: 300 kg.

Hachoir réfrigéré

Goulot: 22. Corps: acier inoxydable. Couteau: auto aiguiser. Interrupteur: inverseur. Puissance: 3 HP. Groupe réfrigérateur hermétique ventilé. Moteur triphasé 220/380 V. Poids: 80 kg. Production: 300 kg/h

Ref.	Euros
MP-32RE-T	4400,00



Despiece / Quartering / Dépeçage

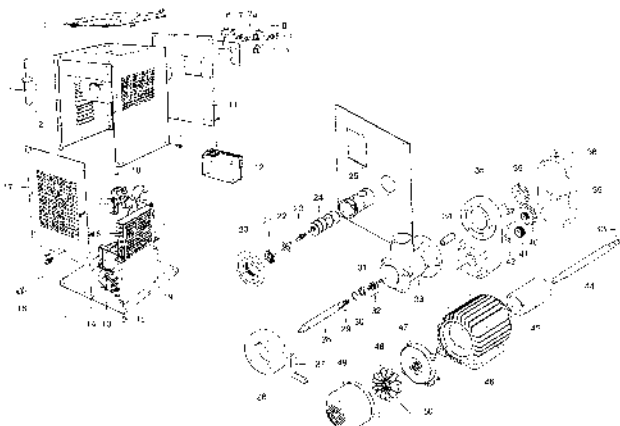

Medidas / Size / Dimensions

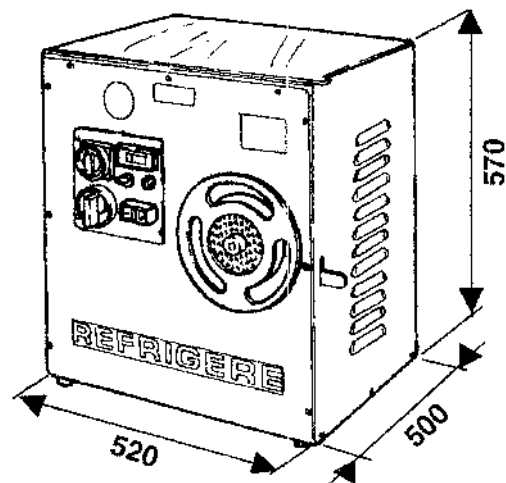



Picadora inox monofase
Boca 8. Cuerpo: acero inoxidable. Grupo picador: acero inoxidable. Cuchilla autoafilante. Motor ventilado. Potencia 0,5 HP. Producción: 70 kg/h.

Stainless steel mincer one phase
 Outlet: 8. Body: stainless steel. Mincer set: stainless steel. Self-sharpening blade. Ventilated engine. Power: 0,5 HP. Producción: 70 kg.

Hachoir inox monophasé 8 HP 0,5
Goulot: 8. Corps: acier inoxydable. Groupe hachoir: acier inoxydable. Lame: aiguseur. Moteur ventilé. Puissance: 0,5 HP. Production: 70 kg/h.

Ref.	Voltaje (V) Voltage (V)	Medidas Size Dimensions	Peso Weight Poids	Euros
MP-8-M	220	27,5 x 25 x 35 cm	9 kg	440,00

Despiece / Quartering / Dépeçage

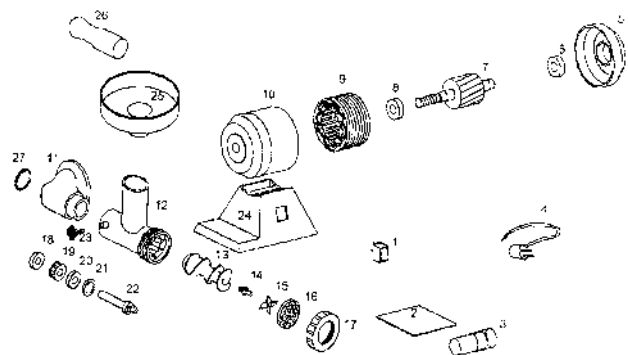



Cuchilla inox 8

Stainless steel blade 8

Lame inox 8

Ref.	Euros
CP-8	14,00

CP-8- - Placa inox picadora 8 con 2 chaveteros

CP-8- - Stainless steel mincer plate 8

CP-8- - Plaque inox hachoir 8

Ref.	Diámetro Diameter Diamètre	Euros
CP-8-3	Ø 3 mm	24,00
CP-8-3,5	Ø 3,5 mm	22,00
CP-8-4	Ø 4 mm	20,00
CP-8-4,5	Ø 4,5 mm	20,00
CP-8-5	Ø 5 mm	19,00
CP-8-6	Ø 6 mm	19,00
CP-8-7	Ø 7 mm	19,00
CP-8-8	Ø 8 mm	19,00



Cuchilla inox 12

Stainless steel blade 12

Lame inox 12

Ref.	Euros
CP-12	10,00

Placa inox 12

Stainless steel plate 12

Plaque inox 12

Ref.	Diámetro Diameter Diamètre	Euros
CP-12-3	Ø 3 mm	21,00
CP-12-3,5	Ø 3,5 mm	19,00
CP-12-4	Ø 4 mm	16,00
CP-12-4,5	Ø 4,5 mm	16,00
CP-12-5	Ø 5 mm	15,00
CP-12-6	Ø 6 mm	15,00
CP-12-7	Ø 7 cm	14,50
CP-12-8	Ø 8 mm	14,50



2 chaveteros

2 keyways

2 rainures de clavette

Ref.	Euros
CP-2C	7,00



Cuchilla inox 22

Stainless steel 22

Lame inox 22

Ref.	Euros
CP-22	13,00

Placa inox 22

Placa inox 22

Plaque inox 22

Ref.	Diámetro Diameter Diamètre	Euros
CP-22-3	Ø 3 mm	28,00
CP-22-3,5	Ø 3,5 mm	25,50
CP-22-4	Ø 4 mm	20,00
CP-22-4,5	Ø 4,5 mm	20,00
CP-22-5	Ø 5 mm	19,50
CP-22-6	Ø 6 mm	19,50
CP-22-7	Ø 7 mm	19,00
CP-22-8	Ø 8 mm	19,00



2 chaveteros

2 keyways

2 rainures de clavette

Ref.	Euros
CP-2C	7,00



Cuchilla inox 32

Stainless steel blade 32

Lame inox 32

Ref.	Euros
CP-32	15,00

Placa inox 32

Placa inox 32

Plaque inox 32

Ref.	Diámetro Diameter Diamètre	Euros
CP-32-3	Ø 3 mm	41,50
CP-32-3,5	Ø 3,5 mm	37,50
CP-32-4	Ø 4 mm	30,50
CP-32-4,5	Ø 4,5 mm	30,50
CP-32-5	Ø 5 mm	29,00
CP-32-6	Ø 6 mm	29,00
CP-32-7	Ø 7 mm	28,00
CP-32-8	Ø 8 mm	28,00



2 chaveteros

2 keyways

2 rainures de clavette

Ref.	Euros
CP-2C	7,00

ACCESORIOS PICADORAS-EMBTIDORAS-AFILADORAS | MINCER-SAUSAGE FILLER-SHARPENER ACCESSORIES | ACCESSOIRES HACHOIRS EMBOUTISSEUSES AIGUISEUSES



Empujador picadoras inyección

Mincer pusher, injection

Poussoir hachoirs injection

Ref.	Diámetro Diameter Diamètre	Largo Long Longueur	Euros
A-35-11	Ø 5 cm	11 cm	10,00
A-35-13	Ø 5 cm	13 cm	10,00
A-35-15	Ø 5 cm	15 cm	10,50
A-35-26	Ø 4,5 cm	12,5 cm	9,00



Empujador picadoras polietileno

Polyethylene mincer pusher

Poussoir hachoirs polyéthylène

Ref.	Diámetro Diameter Diamètre	Largo Long Longueur	Euros
A-36-11	Ø 5 cm	11 cm	30,00
A-36-13	Ø 5 cm	13 cm	31,00
A-36-15	Ø 5 cm	15 cm	34,00



N

Cintas de sierra para carne

Características 16 x 0,4 mm. Tamaño del diente 7 mm. Corte de carne fresca sin hueso o pequeños huesos

Meat band saws
Features 16 x 0.4 mm. Tooth size 7 mm. Cut of fresh meat without bone or small bones

Sciés à ruban de viande
Caractéristiques 16 x 0.4 mm. Taille de dent 7 mm. Couper de la viande fraîche sans os ou petits os

Ref.	Largo Long Longueur	Unidades Units Unités	Euros
SCA-1600	1600 mm	4	33,50
SCA-1740	1740 mm	4	36,00
SCA-1750	1750 mm	4	36,00
SCA-1985	1985 mm	4	37,50
SCA-2120	2120 mm	4	38,50
SCA-2340	2340 mm	4	40,00
SCA-2520	2520 mm	4	43,50
SCA-2930	2930 mm	4	46,50



N

Cintas de sierra para hueso

Características 16 x 0,50 mm. Tamaño del diente 6,35 mm (4 dientes pulgada). Corte de hueso

Bone saw bands
Characteristics 16 x 0,50 mm. Tooth size 7 mm (4 teeth inch). Bone cutting

Sciés à ruban pour l'os
Caractéristiques 16 x 0,50 mm. Taille de dent 7 mm (4 dents pouces). Coupe d'os

Ref.	Largo Long Longueur	Unidades Units Unités	Euros
SHU-1600	1600 mm	4	39,00
SHU-1740	1740 mm	4	41,00
SHU-1750	1750 mm	4	41,00
SHU-1985	1985 mm	4	45,50
SHU-2120	2120 mm	4	47,50
SHU-2340	2340 mm	4	49,00
SHU-2520	2520 mm	4	53,00
SHU-2930	2930 mm	4	61,50

Cintas de sierra para congelados

Características 16 x 0,56 mm. Tamaño diente 8,46 mm (3 dientes/pulgada). Corte de carne, pescado y congelados

Saw bands for frozen
Characteristics 16 x 0.56 mm. Tooth size 8.46 mm (3 teeth / inch).
Cut of meat, fish and frozen

Rubans de scie pour congelés
Caractéristiques 16 x 0.56 mm. Taille de denture 8.46 mm (3 dents / pouce). Coupe de viande, poisson et congelé

Ref.	Largo Long Longueur	Unidades Units Unités	Euros
SCO-1600	1600 mm	4	39,00
SCO-1740	1740 mm	4	41,00
SCO-1750	1750 mm	4	41,00
SCO-1985	1985 mm	4	45,50
SCO-2120	2120 mm	4	47,50
SCO-2340	2340 mm	4	49,00
SCO-2520	2520 mm	4	53,00
SCO-2930	2930 mm	4	61,50



N

Características técnicas Technical specifications Caractéristiques techniques	MC-E300	MC-E350	MC-M350
Cuchilla alemana German blade Lame allemande	300	350	350
Potencia Power Pissance	0.37 KW / 0.5 HP	0.37 KW / 0.5 HP	0.37 KW / 0.5 HP
Voltaje Voltage Voltage	230 V	230 V	230 V
Espesor corte Cutting thickness Dimensions ext.	0-15	0-15	0-24
Medidas exteriores Exterior measurement Mesures extérieures	519 x 620 x 450	560 x 695 x 520	590 x 840 x 550
Medidas base apoyo A-L Base size Dimensions base	360 x 480	390 x 540	480 x 605
Peso Weight Poids	30 kg	38 kg	40 kg
Afilador incorporado Sharpener Aiguiseur	SI / YES / OUI	SI / YES / OUI	SI / YES / OUI
Transmisión Transmission Transmission	CORREA / BELT / COURROIE	CORREA / BELT / COURROIE	DIRECTA
Aluminio anodizado anticorrosivo Aluminium anodized anticorrosive Aluminium anodisé anticorrosif	SI / YES / OUI	SI / YES / OUI	SI / YES / OUI
Capacidad corte (grueso) Slicing capacity (thickness) Capacité de coupe (épaisseur)	170 x 250	200 x 280	185 x 300
Precio P.V.P Retail price Prix conseillé	1995,00 €	2295,00 €	3365,00 €



Características técnicas Technical specifications Caractéristiques techniques	MC-220-AF	MC-250-C	MC-300-E	MC-350-I
Cuchilla alemana German blade Lame allemande	220	250	300	350
Potencia Power Pussance	186 W / 0,25 HP	225 W / 0,30 HP	260 W / 0,35 HP	372 W / 0,50 HP
Voltaje Voltage Voltage	230 V	230 V	230 V	230 V
Espesor corte Cutting thickness Dimensions ext.	0-15	0-16	0-16	0-16
Medidas exteriores Exterior measurement Mesures extérieures	405 x 580 x 340	425 x 620 x 370	595 x 650 x 440	585 x 890 x 480
Medidas base apoyo A-L Base size Dimensions base	280 x 415	390 x 440	240 x 465	415 x 580
Peso Weight Poids	13,5 kg	15,5 kg	23 kg	36 kg
Afilador incorporado Sharpener Aiguiseur	SI / YES / OUI	SI / YES / OUI	SI / YES / OUI	SI / YES / OUI
Transmisión Transmission Transmission	CORREA / BELT / COURROIE	CORREA / BELT / COURROIE	CORREA / BELT / COURROIE	CORREA / BELT / COURROIE
Aluminio anodizado anticorrosivo Aluminium anodized anticorrosive Aluminium anodisé anticorrosif	SI / YES / OUI	SI / YES / OUI	SI / YES / OUI	SI / YES / OUI
Capacidad corte (grueso) Slicing capacity (thickness) Capacité de coupe (épaisseur)	160 x 190	190 x 220	220 x 220	360 x 310
Precio P.V.P Retail price Prix conseillé	575,00 €	690,00 €	1055,00 €	1715,00 €

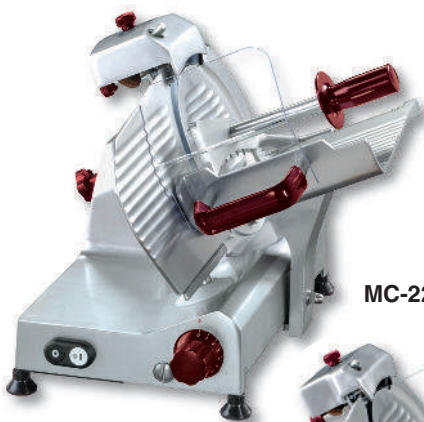

MC-220-AF

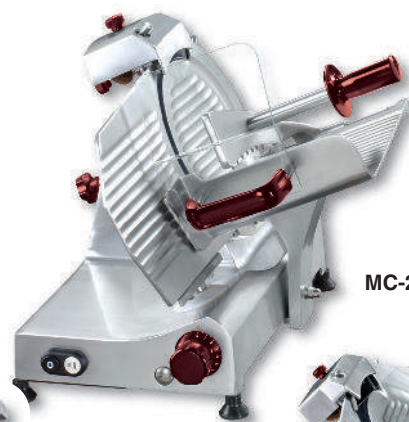

MC-250-C

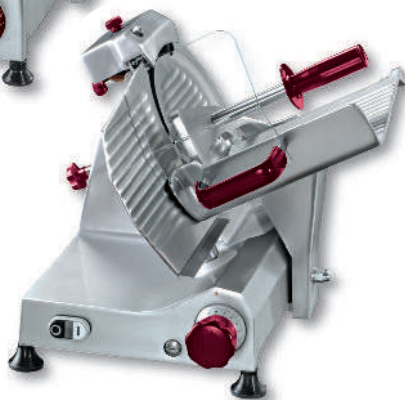

MC-300-E



MC-350-I

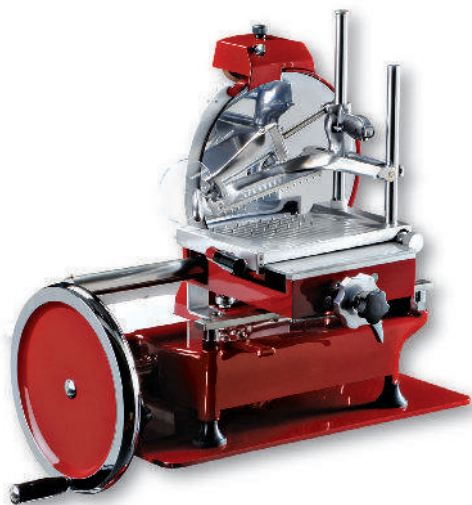

**Cortadora fiambres manual 250. Espesor corte 0+2.
Capacidad corte (Grueso) de 150 x 185 mm. Posición sobremesa.**

Cold cuts cutter manual 250. Cut thickness 0+2.
Cutting capacity (thickness) 150 x 185 mm. Position desktop.

*Coupante charcuterie manual 250. Épaisseur de coupe 0+2.
Capacité coupure (épaisseur) 150 x 185 mm. Position sur table.*

Ref.	Euros
MC-250-VOL	3146,00



**Cortadora fiambres manual 300. Espesor corte 0+2.
Capacidad corte (Grueso) de 190 x 230 mm. Posición sobremesa.**

Cold cuts cutter manual 300. Cut thickness 0+2.
Cutting capacity (thickness) 190 x 230 mm. Position desktop.

*Coupante charcuterie manual 300. Épaisseur de coupe 0+2.
Capacité coupure (épaisseur) 190 x 230 mm. Position sur table.*

Ref.	Euros
MC-300-VOL	3420,00



Soporte columna para MC-250/300-VOL

Column support for MC-250/300-VOL

Support colonne pour MC-250/300-VOL

Ref.	Euros
MC-2530	1160,00

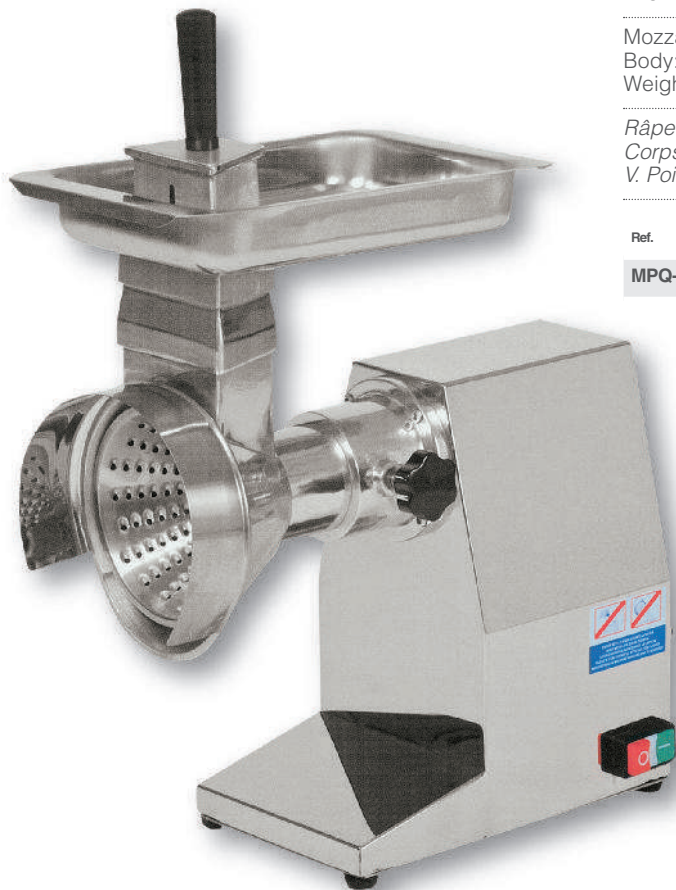

Ralladora mozzarella

Cuerpo: acero inoxidable. Potencia: 0,35 HP. Motor monofásico 220 V. Peso 14 kg. Producción: 50 kg/h.

Mozzarella grater

Body: stainless steel. Power: 0,35 HP. Motor: one phase 220 V. Weight : 14 kg. Production: 50 Kg/h.

Râpe à fromage

Corps: acier inoxydable. Puissance 0,35 HP. Moteur: monophasé 220 V. Poids: 14 kg. Production: 50 kg/h.

Ref.	Euros
MPQ-MOZZARELLA	890,00



Campana agujero 2 mm. para queso en hilo

Cone shaped grater with 2 mm holes for shredded cheese

Cloche trou 2 mm pour fromage filé

Ref.	Euros
MPQ-MOZ-15	82,00



Despiece / Quartering / Dépeçage

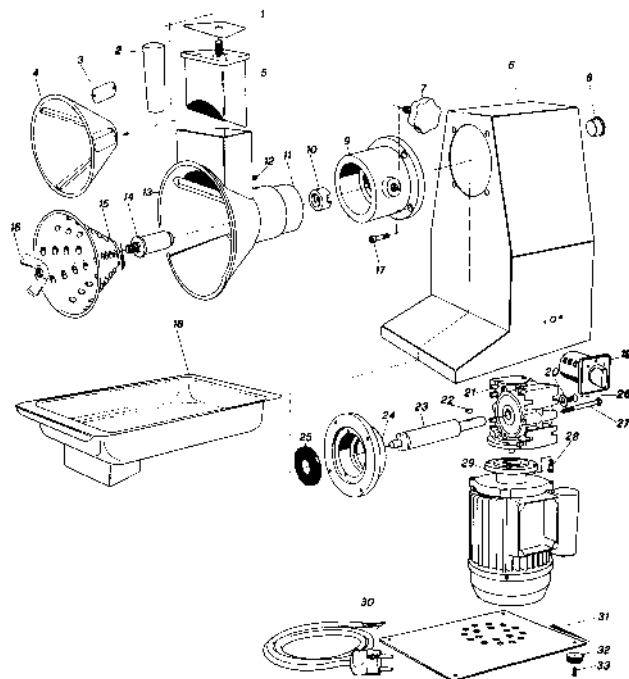

Ralladora motor estanco HP 0,5, monofase 220 V.

Grater protected engine HP 0,5, one phase 220 V

Râpe moteur protégé HP 0,5, monophasé 220 V.

Ref.	Euros
MPQ-02	962,00



Disco parmesano para ref. MPQ-02

Parmesan disk for ref. MPQ-02

Disque parmesan pour réf. MPQ-02

Ref.	Euros
DR-0	62,00

Disco agujero para ref. MPQ-02

Hole disk for ref. MPQ-02

Disque trou pour réf MPQ-02

Ref.	Tipo Type Type	Euros
DR-2	2 mm	62,00
DR-3	3 mm	62,00
DR-4	4 mm	62,00
DR-6	6 mm	62,00
DR-8	8 mm	62,00

Disco hielo para ref. MPQ-02

Ice disk for ref. MPQ-02

Disque glace pour réf. MPQ-02

Ref.	Euros
DRH	99,00



EXPRIMIDOR CÍTRICOS | CITRUS JUICER | PRESSE-CITRON

Exprimidor cítricos Santos nº 10

Citrus juicer Santos nº 10

Presse-citron Santos nº 10

Ref.	Euros
MSE-10	698,00

Máquina ralladora-cortadora multifunción

Cuerpo: acero inoxidable y aleación especial. Potencia: HP 0,75. Motor: trifásico 230/380 V. Peso 20 kg. Producción: 150-300 kg/h

Multi purpose grater-slicer machine
Body: stainless steel with special alloy. Power: 0,75 HP. Engine: three phase 230/380 V. Weight: 20 Kg. Production: 150-300 kg/h

*Machine à râpe-découpoir multifonction
Corps: acier inoxydable et alliage spécial. Puissance: 0,75 HP. Moteur: triphasé 230-380 V. Poids: 20 kg. Production : 150-300 kg/h*

Ref.	Euros
MPQV-5-T	1116,00

Máquina ralladora-cortadora multifunción

Cuerpo: acero inoxidable y aleación especial. Potencia: HP 0,75. Motor: monofásico 230 V. Peso 20 kg. Producción: 150-300 kg/h

Multi purpose grater-slicer machine
Body: stainless steel with special alloy. Power: 0,75 HP. Engine: One phase 230 V. Weight: 20 Kg. Production: 150/300 kg/h

*Machine à râpe-découpoir multifonction
Corps: acier inoxydable et alliage spécial. Puissance: 0,75 HP. Moteur: monophasé 230V. Poids: 20 kg. Production : 150-300 kg/h*

Ref.	Euros
MPQV-5-M	1100,00



Despiece / Quartering / Dépeçage

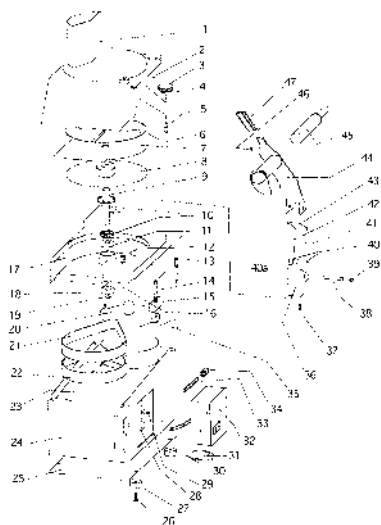

Medidas / Size / Dimensions

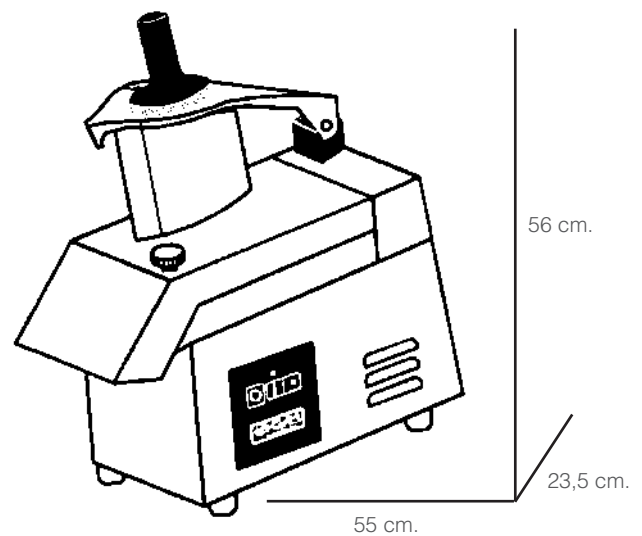

DISCOS RALLADORES HILO-POLVO PARA QUESO, VERDURAS, PAN Y FRUTOS SECOS | STRING-FINE SHRED GRATER DISKS FOR CHEESE, VEGETABLES, BREAD CRUMBS AND NUTS | DISQUES À RÂPER FIL POUDRE POUR FROMAGE, LÉGUMES, PAIN ET FRUITS SECS



Disco para hilo

Disk for slices

Disque pour rondelles

Ref.	Tipo Type	Euros
DZ-2	2 mm	75,00
DZ-3	3 mm	75,00
DZ-4	4 mm	75,00
DZ-7	7 mm	75,00

Disco para polvo

Fine shred disk

Disque pour poudre

Ref.	Euros
DV	75,00

DISCO PARA CORTE EN RODAJAS | SLICING DISKS | DISQUES POUR COUPER EN RONDELLES

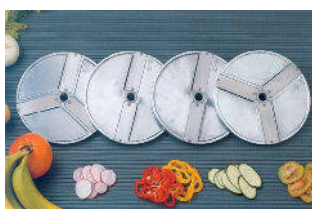

Disco para rodajas

Disk for slice

Disque pour rondelles

Ref.	Tipo Type	Euros
DE-1	1 mm	74,00
DE-2	2 mm	74,00
DE-3	3 mm	74,00
DE-4	4 mm	78,00



Disco para rodajas

Disk for slice

Disque pour rondelles

Ref.	Tipo Type	Euros
DE-6	6 mm	78,00
DE-8	8 mm	78,00
DE-10	10 mm	78,00
DE-14	14 mm	78,00

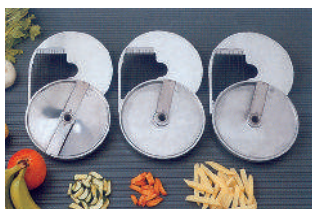

Accesorios rejilla a tiras (patatas fritas)

Strip slicer accessories (fried chips)

Accessoires grille en lamelles (frites)

Ref.	Tipo Type	Euros
DB-6	6 mm (DE-6)	100,00
DB-8	8 mm (DE-8)	100,00
DB-10	10 mm (DE-10)	100,00



Accesorios rejilla cubos

Dicing accessories

Accessoires grille dés

Ref.	Tipo Type	Euros
DD-8	8 x 8 mm (DE-8)	128,00
DD-10	10 x 10 (DE-10)	128,00
DD-20	20 x 20 mm (DE-14)	128,00

DISCO CURVO CORTE BLANDO EN RODAJAS TOMATES, NARANJA, LIMÓN, PLÁTANO, ETC | CURVED DISK, SLFT CUT IN SLICES, TOMATOES, ORANGE, LEMON, BANANA, ETC. | DISQUE COURBE DÉCOUPE TENDRE EN RONDELLES, TOMATES, ORANGE, CITRON, BANANE, ETC.



Disco curvado corte blando

Curved disk soft cut

Disque courbe découpe tendre

Ref.	Tipo Type	Euros
DS-1	1 mm	78,00
DS-2	2mm	78,00
DE-5	5 mm	78,00

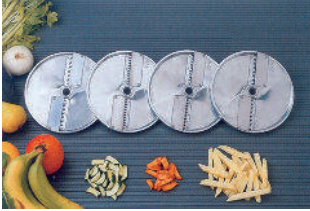

Disco para rodajas onduladas

Disk for wavy slices

Disque pour rondelles ondulées

Ref.	Diámetro Diameter Diamètre	Euros
DH-2,5	Ø 2,5 mm	110,00
DH-4	Ø 4 mm	110,00
DH-6	Ø 6 mm	110,00
DH-8	Ø 8 mm	110,00
DH-10	Ø 10 mm	110,00

DISCO DE CORTE REGULABLE | ADJUSTABLE SLICER DISK | DISQUE DÉCOUPE RÉGLABLE



Disco corte en rodajas regulable de 1 a 8 mm

Kisk for adjustable slices 1 to 8 mm

Disque pour rondelles réglable de 1 à 8 mm

Ref.	Euros
DX-1	180,00

ACCESORIOS DISCOS | DISKS ACCESSORIES | DISQUES ACCESSOIRES

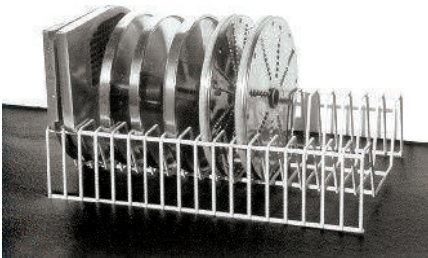

Soporte portadiscos

Disk-rack

Support porte-disques

Ref.	Medidas Size Dimensions	Euros
DA-18	39,5 x 25,6 x 10 cm	41,00

Disco expulsor para ref. MPQV-5

Disk remover for ref MPQV-5

Disque expulseur pour réf. MPQV-5

Ref.	Euros
DA-1	25,00



Cutter 3 L
Cuerpo: acero inoxidable. Potencia : 480W. Motor: monofásico 230 V. Velocidad variable: 900-2200 rpm. Peso: 11 kg. Dimensiones cubeta: 18 Ø x 10,5 cm altura. Incluye cuchilla lisa.

Cutter 3 L
 Body: stainless steel. Power 480W. Engine: one phase 230 V. Variable speed: 900/2200 rpm. Weight: 11 kg. Bowl sizes: 18 Ø x 10,5 cm height. Includes smooth blade

Cutter 3 L
 Corps: acier inoxydable. Puissance 480W. Moteur: monophasé 230 V. Vitesse variable: 900/2200 rpm. Poids: 11 kg. Dimensions bac: 18 Ø x 10,5 cm hauteur. Comprend lame lisse.

Ref.	Euros
MC-3	1022,00

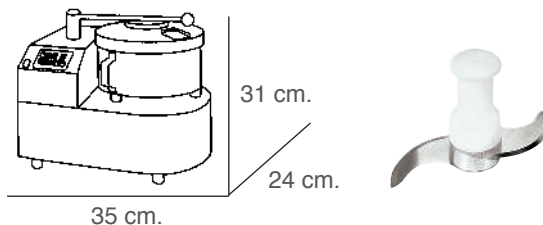

MC-CL-X - Cuchilla lisa afilada para triturar

MC-CL-X - Smooth blade sharpened for grinding

MC-CL-X - Lame lisse aiguisée pour triturer



MC-CD-X - Cuchilla dentada para triturar

MC-CD-X - Tooth blade for grinding

MC-CD-X - Lame dentelée pour triturer

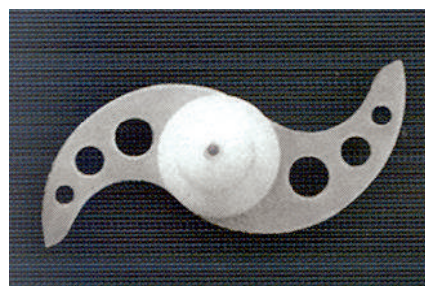

MC-CP-X - Cuchilla perforada para batir y amasar

MC-CP-X - Perforated blade for mixing and kneading

MC-CP-X - Lame perforée pour battre et pétrir

Ref.	Tipo Type Type	Euros
MC-CL-3	MC-3	86,00
MC-CL-5	MC-5, MC-8	129,00

Ref.	Tipo Type Type	Euros
MC-CD-3	MC-3	86,00
MC-CD-5	MC-5, MC-8	129,00

Ref.	Tipo Type Type	Euros
MC-CP-3	MC-3	86,00
MC-CP-5	MC-5, MC-8	129,00



Puré de tomate / Purée tomato / Purée de tomate: 60 seg.

Mayonesa / Mayonnaise / Purée de tomate: 130 seg.

Perejil, ajo, cebolla, pimiento triturado / Parsley, garlic, onion pepper grinded / Persil, ail, oignon et le poivron moulu: 15 seg.

Pan rallado / Breadcrumbs / Chapelure: 60 seg.

Chocolate / Chocolate / Chocolat : 60 seg.



Frutos secos triturados / Dried fruits grinded / Fruits secs broyés: 20 seg.

Mozzarella para pizza / Pizza mozzarella / Mozzarella pour pizza: 10 seg.

Carne triturada / Grinded meat / Viande broyée: 10 seg.

Amasijos tiernos para pastelería / Bakery mixture / Pâtisserie: 60 seg. / Puré de verduras / Purée vegetables / Purée de légumes: 5 seg.

**Cutter 5 L**

Cuerpo: acero inoxidable. Potencia : 960W. Motor: monofásico 230 V. Velocidad variable: 900-2200 rpm. Peso: 18 kg. Dimensiones cubeta: 24 Ø x 12 cm altura. Incluye cuchilla lisa.

Cutter 5 L

Body: stainless steel. Power 960W. Engine: one phase 230 V. Variable speed: 900/2200 rpm. Weight: 18 kg. Bowl sizes: 24 Ø x 12 cm height. Includes smooth blade

Cutter 5 L

Corps: acier inoxydable. Puissance 960W. Moteur: monophasé 230 V. Vitesse variable: 900/2200 rpm. Poids: 18 kg. Dimensions bac: 24 Ø x 12 cm hauteur. Comprend lame lisse.

Ref.	Euros
MC-5	1320,00

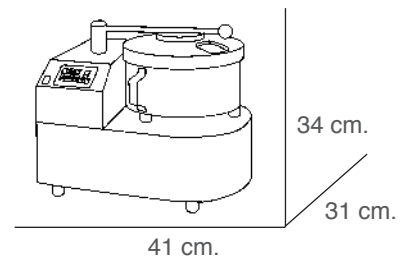
**Cutter 8 L**

Cuerpo: acero inoxidable. Potencia : 960W. Motor: monofásico 230 V. Velocidad variable: 900-2200 rpm. Peso: 19 kg. Dimensiones cubeta: 24 Ø x 18 cm altura. Incluye cuchilla lisa.

Cutter 8 L

Body: stainless steel. Power 960W. Engine: one phase 230 V. Variable speed: 900/2200 rpm. Weight: 19 kg. Bowl sizes: 24 Ø x 18 cm height. Includes smooth blade

Cutter 8 L

Corps: acier inoxydable. Puissance 960W. Moteur: monophasé 230 V. Vitesse variable: 900/2200 rpm. Poids: 19 kg. Dimensions bac: 24 Ø x 18 cm hauteur. Comprend lame lisse.

Ref.	Euros
MC-8	1455,00

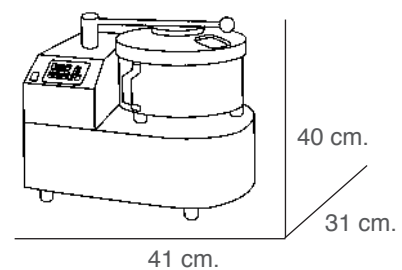

**Máquina enternecedor de carne
Cuchillas desmontables, fácil limpieza.**

**Potencia: 0,50 HP. Cuchillas acero-inox con 180 microcortes por
Dm². Motor monofásico 220 V.**

Meat tenderizer
Detachable blades, easy cleaning.

Power: 0,50 HP. Stainless steel blades with 180 micro cuts per Dm².
Motor: one phase 220 V.

Attendrisseur viande
Couteaux séparables, nettoyage facile.

Puissance: 0,50 HP. Couteaux acier inox avec 180 micro entailles par
Dm². moteur: monophasé 220 V.



Ref.	Medidas Size Dimensions	Peso Weight Poids	Euros
MPE-18	41 x 19 x 40 cm	17 kg	2120,00



Molino pimienta
Potencia: 1 HP. Producción: 12 kg/h

Pepper mill
 Power: 1 HP. Production: 12 kg/h

Moulin à poivre
Puissance: 1 HP. Production: 12 kg/h



Ref.	Medidas Size Dimensions	Peso Weight Poids	Euros
MPP-10	22 x 34 x 61 cm	12 kg	665,00



AFILADORA | SHARPENER | AIGUISEUR

Afilador mini
Afilado: 2 piedras: 1 afilado y 1 pulido

Mini sharpener
 Sharpening: 2 stones: 1 sharp. & 1 polish

Aiguiser mini
Aiguisage: 2 pierres: 1 aiguisée et 1 polie.



Ref.	Medidas Size Dimensions	Voltaje (V) Voltage (V) Voltage (V)	Euros
A-198	22 x 9 x 8 cm	220	120,00

Juego 2 piedras con eje para ref. A-198

Stone set for ref. A-198

Ensemble 2 pierres pour réf. A-198

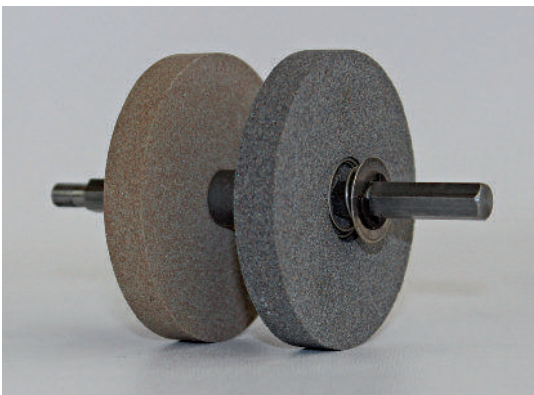

Ref.	Euros
A-198-1	32,00



0 3 AFILADORA | SHARPENER | AIGUISEUR

Máquina afilar banda

Potencia: 0,35 HP. Revoluciones: 2800 rpm. Motor: monofásico 220 V.

Band-sharpening machine

Power: 0.35 HP. Revoluciones: 2800 rpm. Engine: One phase 220 V.

Machine à aiguiser bande

Puissance: 0,35 HP. Révolutions: 2800 rpm. Moteur: Monophasé 220 V.

Ref.	Medidas Size Dimensions	Voltaje (V) Voltage (V) Voltage (V)	Peso Weight Poids	Euros
A-200	33 x 28 x 40 cm	220	9 kg	545,00

Afilar / Sharpen / Aiguiser



Pulir / Polish / Polir

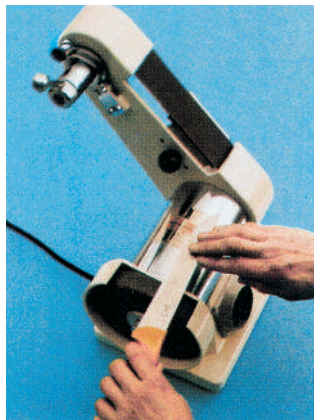

Banda afilar para ref. A-200

Sharpening band for ref. A-200

Bande aiguiser pour réf. A-200



Ref.	Euros
N A-200-13X Circonio	5,00
A-200-13	4,00

Disco pulir para ref. A-200

Polishing disk for ref. A-200

Disque polir pour réf. A-200



Ref.	Euros
A-200-33	50,00

Despiece / Quartering / Dépeçage

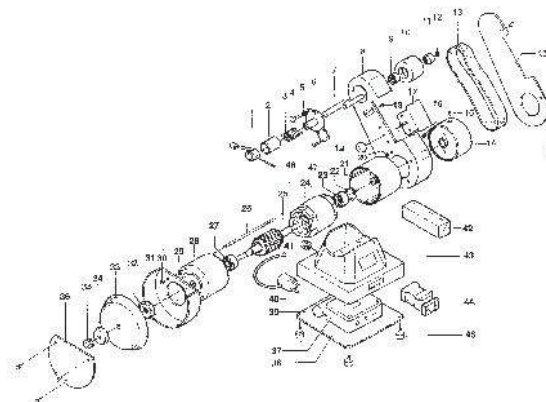

0

4

Maquinas retractilar, Film, Dispensadores de film, Dispensador papel aluminio, Soldadoras de bolsas, Máquina sellar, Máquina vacío, Parrilla envasadora, Bolsas vacío, Termoselladora.

Wrapping machines, Film, Film dispensers, Aluminium foil dispenser, Bag sealer, Sealer machine, Vacuum machine, Packaging grill, Vacuum bags, Thermo sealer.

Machine à retractiler, Film, Dispensateurs film, Dispensateur papier aluminium, Scelleuse de sacs, Machine à sceller, Machine vide, Grill à sceller, Sacs sous vide, Thermo machine.

87-100



Máquina retractilar, acero-inox
Con placa de calor. Interruptor para placa calor ON/OFF. Interruptor para resistencia corte ON/OFF.

Wrapping machine, stainless steel
 Featuring heat plate. Heat plate ON/OFF switch.ON/OFF switch for cut resistance.

Machine à rétractiler, acier-inox
Avec plaque de chauffage. Interrupteur pour plaque de chauffage ON/OFF. Interrupteur pour résistance découpe ON/OFF.

Ref.	Medidas Size Dimensions	Resistencia corte Cut resistance Résistance à la découpe	Bobina film Film roll Bobine film	Voltaje (V) Voltage (V) Voltage (V)	Euros
MR-4-ECO	59 x 48,5 x 13,5 cm	46 cm	MR-40/45	220	190,00
MR-4-500-ECO	59 x 52 x 13,5 cm	50 cm	MR-40/45/47	220	250,00



Máquina retractilar, acero-inox
Con placa de calor. Interruptor para placa calor ON/OFF. Interruptor para resistencia corte ON/OFF.

Wrapping machine, stainless steel
 Featuring heat plate. Heat plate ON/OFF switch.ON/OFF switch for cut resistance.

Machine à rétractiler, acier-inox
Avec plaque de chauffage. Interrupteur pour plaque de chauffage ON/OFF. Interrupteur pour résistance découpe ON/OFF.

Ref.	Medidas Size Dimensions	Resistencia corte Cut resistance Résistance à la découpe	Voltaje (V) Voltage (V) Voltage (V)	Bobina film Film roll Bobine film	Euros
MR-4	59 x 48,5 x 13,5 cm	45 cm	220	MR-40/45	235,00
MR-4-500	59 x 52 x 13,5 cm	50 cm	220	MR-40/45/47	280,00
MR-4-600	65 x 62 x 13,4 cm	60 cm	220	MR-40/45/46/47	380,00



Máquina retractilar
Con placa de calor. Interruptor para placa calor ON/OFF. Interruptor para resistencia corte ON/OFF. Ideal para espacios reducidos al llevar la bobina de film en su interior.

Wrapping machine
 Featuring heat plate. Heat plate ON/OFF switch.ON/OFF switch for cut resistance. Ideal for small spaces because it incorporates the film roll inside.

Machine à rétractiler
Avec plaque de chauffage. Interrupteur pour plaque de chauffage ON/Off. Interrupteur pur résistance découpe ON/OFF. Idéal pour les petits espaces car il intègre le rouleau de film à l'intérieur.

Ref.	Medidas Size Dimensions	Bobina film Film roll Bobine film	Resistencia corte Cut resistance Résistance à la découpe	Euros
MR-1	48 x 45 x 19 cm	MR-20/30	45 cm	255,00
MR-1-ECO	48 x 45 x 19 cm	MR-20/30	46 cm	220,00



Máquina retractilar
Sin placa de calor. Interruptor ON/OFF.

Wrapping machine
 Without heat plate. Heat plate ON/OfF.

Machine à rétractiler
 Sans plaque de chauffage. Interrupteur pour plaque de chauffage ON/OFF.

Ref.	Medidas Size Dimensions	Resistencia corte Cut resistance Résistance à la découpe	Bobina film Film roll Bobine film	Voltaje (V) Voltage (V) Voltage (V)	Euros
MR-2	48,5 x 27 x 17,5 cm	45 cm	MR-20	220	195,00



Máquina retractilar
Sin placa de calor. Interruptor ON/OFF.

Wrapping machine
 Without heat plate. Heat plate ON/OFF switch. **BOBINAS FILM | FILM ROLLS | BOBINES FILM**

Machine à rétractiler
 Sans plaque de chauffage. Interruteur pour plaque de chauffage ON/OFF.

Ref.	Medidas Size Dimensions	Resistencia corte Cut resistance Résistance à la découpe	Bobina film Film roll Bobine film	Voltaje (V) Voltage (V) Voltage (V)	Euros
MR-3	34,5 x 27 x 17,5 cm	30 cm	MR-30	220	160,00



Bobinas de film

Film rolls

Bobines film

Ref.	Medidas Size Dimensions	Euros
MR-20	40 x 500 cm	21,00
MR-30	30 x 500 cm	16,00
MR-40	40 x 1500 cm	42,00
MR-45	45 x 1500 cm	47,00
MR-47	50 x 1500 cm	53,00
MR-46	60 x 1500 cm	64,00
MR-49	90 x 1500 cm	94,00
MR-50	30 x 300 cm	6,50
MR-60	45 x 300 cm	9,60



Dispensador inox con cuchilla
Posición sobre mesa ó pared.

Stainless steel dispenser with cutter
Free standing or attached to wall.

Distributeur inox avec lame
Pose sur table ou mur.

Ref.	Medidas Size Dimensions	Bobina film Film roll Bobine film	Euros
MR-10	36 x 12,5 x 9 cm	MR-50	65,00
MR-11	50 x 12,5 x 9 cm	MR-60	77,00
MR-10-1	Cuchilla para / Blade for / Lame pour		7,00

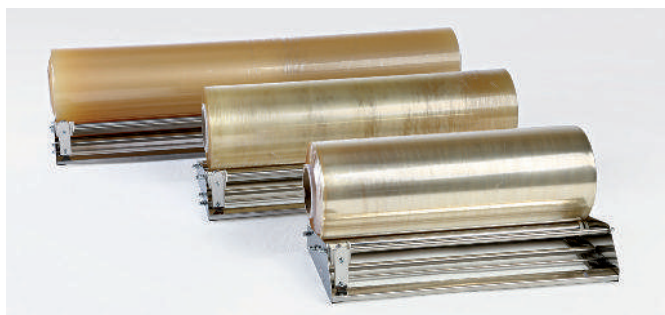

Dispensador inox con cuchilla
Posición sobre mesa ó pared.

Stainless steel dispenser with cutter
Free standing or attached to wall.

Distributeur inox avec lame
Pose sur table ou mur.

Ref.	Medidas Size Dimensions	Bobina film Film roll Bobine film	Euros
MR-12	50 x 22 x 9 cm	MR-45	155,00
MR-13	63 x 22 x 9 cm	MR-46/47	205,00
MR-14	95 x 22 x 9 cm	MR-49	405,00



Dispensador acero inox
Posición sobre mesa ó pared.

Stainless steel dispenser
Free standing or attached to wall.

Distributeur acier inox
Pose sur table ou mur.

Ref.	Medidas Size Dimensions	Bobina film Film roll Bobine film	Euros
MRI-5	34 x 16 x 9 cm	MR-50	63,00
MRI-6	49 x 16 x 9 cm	MR-60	67,00

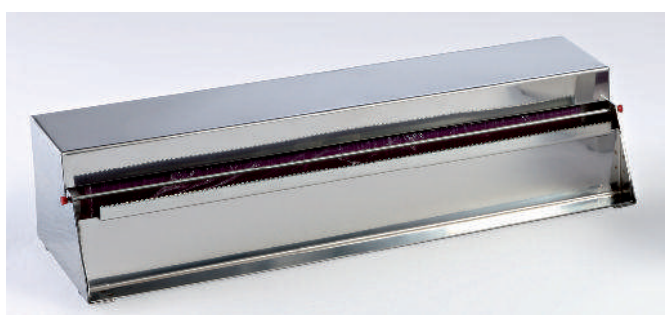

Dispensador con tapa acero-inox
Posición sobre mesa ó pared.

Dispenser with stainless steel top
Free standing or attached to wall.

Distributeur avec couvercle acier inox
Pose sur table ou mur.

Ref.	Medidas Size Dimensions	Bobina film Film roll Bobine film	Euros
MRIT-5	34 x 16 x 12 cm	MR-50	86,00
MRIT-6	46 x 16 x 12 cm	MR-60	92,00



MR-5_6 - Dispensador metálico
Con kit de cuchilla para corte.

MR-5_6 - Metal dispenser
With cutting blade kit.

MR-5_6 - Dispensador de metálico
Avec coupe kit de lame.

Ref.	Medidas Size Dimensions	Bobina film Film roll Bobine film	Euros
MR-5	34 x 16 x 9 cm	MR-50	40,00
MR-6	49 x 16 x 9 cm	MR-60	46,00



Dispensador inox papel aluminio 45 cm inox

Stainless steel dispenser for 45 cm aluminium

Dispensateur inox pour aluminium de 45 cm

Ref.	Euros
MR-9	28,00

Papel aluminio

Aluminium foil

Papier aluminium

Ref.	Medidas Size Dimensions	Euros
MR-80	29 x 300 cm	25,00
MR-90	40 x 300 cm	34,00



SOLDADORAS DE BOLSAS | BAG SEALER | SCELLEUSE DE SACS

Soldadora de bolsas

Con regulador de temperatura, posición sobremesa.

Bag sealer

With temperature regulator, positioning free standing.

Scelleuse de sacs

Régulateur de température, position surtable.

Ref.	Maximum seal Maximum seal Maximum seal	Voltaje (V) Voltage (V) Voltage (V)	Euros
SB-200	20 cm	220	155,00
SB-300	30 cm	220	170,00
SB-400	40 cm	220	200,00
SB-500	50 cm	220	325,00



Soldadora de bolsas

Con regulador de temperatura.

Bag sealer

With temperature regulator.

Scelleuse de sacs

Régulateur de température.

Ref.	Maximum seal Maximum seal Maximum seal	Voltaje (V) Voltage (V) Voltage (V)	Euros
SB-600	60 cm	220	595,00
SB-1000	100 cm	220	850,00



Soldadora de bolsas

Con regulador de temperatura, posición sobremesa.

Bag sealer

With temperature regulator, positioning free standing.

Scelleuse de sacs

Régulateur de température, position surtable.

Ref.	Maximum seal Maximum seal Maximum seal	Voltaje (V) Voltage (V) Voltage (V)	Euros
SB-400-ECO	40 cm	220	135,00



Soldador semiautomático con pedal
Pedal eléctrico, ancho sellado de 5 mm.

Semi-automatic sealer with pedal
 Electric pedal, seal wide a 5 mm.

Scelleuse semi automatique avec pédale
Pédale électrique, largeur scellée 5 mm.

Ref.	Medidas Size Dimensions	Maximum seal Maximum seal Maximum seal	Voltaje (V) Voltage (V) Voltage (V)	Euros
SBPA-450	53,5 x 38 x 88 cm	45 cm	220	1175,00
SBPA-600	68 x 38 x 88 cm	60 cm	220	1475,00

MÁQUINA SELLAR | SEALER MACHINE | MACHINE À SCELLER



Máquina selladora en "U"
Regulador de temperatura, acero-inox - epoxi blanco, posición sobre mesa.

U- sealer machine
 Temperature regulator, stainless steel, positioning free standing.

Machine à sceller en forme de U
Régulateur de température, acier inox époxy blanc, pose sur table.

Ref.	Medidas Size Dimensions	Voltaje (V) Voltage (V) Voltage (V)	Euros
MR-15	35 x 33 x 35 cm	220	475,00



Soldadora de bolsas magnético
Soporte pared opcional. Especial para entrada hipermercados.
Barra de soldadura de 50 cm.

Magnetic bag sealer
 Optional wall bracket. Special for supermarkets entrance. Welding rod 50 cm.

Scelleuse de sacs magnétique
Support mural optionnel. Spécial pour l'entrée des hypermarchés.
Baguette de soudure 50 cm.

Ref.	Voltaje (V) Voltage (V) Voltage (V)	Maximum seal Maximum seal Maximum seal	Euros
SBM-500	220 V	500 mm	871,00

Mesa de trabajo colgada a la pared

Work table hanging on the wall

Table de travail suspendue au mur

Ref.	Euros
SBM-505	338,00



**Máquina envasadora al vacío
Estructura + cuba en acero inox.**

10 programas memoria.

Vacuum packaging machine
Stainless steel structure + cuba.

Memory 10 programs.

*Machine d'emballage sous vide
Estructura + Cuba en acier inoxydable.*

Mémoire 10 programmes.

Ref.	Dimensiones máquina Machine size Dimensions machine	Dimensiones cámara Chamber size Dimensions chambre	Soldadura Seal Soudure	Peso Weight Poids	Bomba vacío Vacuum pump Pompe à vide	Voltaje (V) Voltage (V) Voltage (V)	Euros
MV-6	440 x 360 x 400 mm	300 x 260 x 140 mm	250 mm	30 kg	6 mc/h	230	1975,00
MV-10	440 x 400 x 400 mm	310 x 250 x 190 mm	300 mm	38 kg	10 mc/h	230	2375,00
MV-16	530 x 470 x 450 mm	450 x 410 x 220 mm	400 mm	48 kg	20 mc/h	230	2800,00
MV-21	560 x 610 x 480 mm	500 x 460 x 220 mm	500 mm	60 kg	20 mc/h	230	3475,00



**Máquina envasadora al vacío sin cámara
Estructura acero-inox. Bolsa gofrada.**

10 programas memoria.

Vacuum packaging machine without chamber
Stainless steel body. Embossed bag.

Memory 10 programs.

*Machine d'emballage sous vide sans chambre
Structure en acier inox. Sac gofré.*

Mémoire 10 programmes.

Ref.	Medidas Size Dimensions	Barra soldadura Seal bar Barre soudure	Bomba vacío Vacuum pump Pompe à vide	Peso Weight Poids	Voltaje (V) Voltage (V) Voltage (V)	Euros
MVS-960	50 x 33 x 19 cm	500 mm	30 Lt/min.	12 kg	220	730,00



Máquina envasadora al vacío sin cámara
Estructura acero-inox. Bolsa gofrada.

Vacuum packaging machine without chamber
Stainless steel body. Embossed bag.

Machine d'emballage sous vide sans chambre
Structure en acier inox. Sac gaufré.

Ref.	Medidas Size Dimensions	Barra soldadura Seal bar Barre soudure	Bomba vacío Vacuum pump Pompe à vide	Voltaje (V) Voltage (V) Voltage (V)	Euros
MVS-330	38 x 18 x 11 cm	330 mm	16 Lt/min.	220V	240,00



Máquina envasadora al vacío
Estructura de ABS y PVC

Vacuum packaging machine
ABS and PVC structure

Machine d'emballage sous vide
Structure en ABS et PVC

Ref.	Medidas Size Dimensions	Barra soldadura Seal bar Barre soudure	Bomba vacío Vacuum pump Pompe à vide	Peso Weight Poids	Voltaje (V) Voltage (V) Voltage (V)	Euros
MVS-100	35,7 x 14,8 x 7,3 cm	300 mm	10 Lt/min.	1,5 kg	220V	140,00

PARRILLA ENVASADORA | PACKAGING GRILL | GRILL À EMBALLER

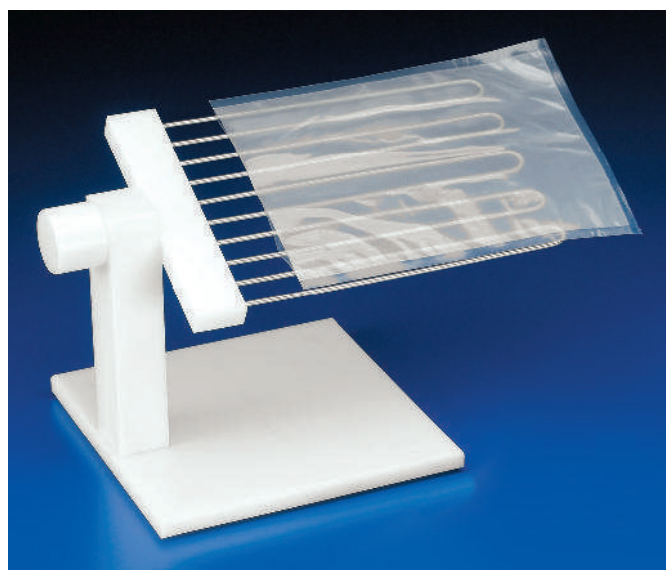

Parrilla envasadora para bolsa vacío
Base polietileno. Varillas acero inox. Pomo giratorio

Packing grill for vacuum bags
Polyethylene base. Stainless steel rods. Rotating knob

Grill à emballer pour sacs sous vide
Base polyéthylène. Tiges acier inox. Pommeau giratoire

Ref.	Euros
A-75	77,00



Paloenvasadora para bolsa vacío
Base polietileno.

Packing grill for vacuum bags
Polyethylene base.

Grill à emballer pour sacs sous vide
Base polyéthylène.

Ref.	Medidas Size Dimensions	Euros
A-76	38 x 18 cm	9,50
A-77	34 x 15 cm	8,50

BOLSAS VACIO | VACUUM BAGS | SACS SOUS VIDE



Bolsa vacío gofrada

Economic embossed vacuum bag

Sac sous vide gaufré économique

Ref.	Medidas Size Dimensions	Unidades Units Unités	Euros
BVX-1525	15 x 25 cm	100	7,90
BVX-1535	15 x 35 cm	100	11,10
BVX-1545	15 x 45 cm	100	14,20
BVX-2020	20 x 20 cm	100	8,50
BVX-2030	20 x 30 cm	100	12,70
BVX-2040	20 x 40 cm	100	16,90
BVX-2535	25 x 35 cm	100	18,40
BVX-3040	30 x 40 cm	100	25,30
BVX-3050	30 x 50 cm	100	31,60



Rollo gofrado 20 x 600

Embossed roller 20 x 600

Rouleau gaufré 20 x 600

Ref.	Medidas Size Dimensions	Unidades Units Unités	Euros
BVX-R20	20 x 600 cm	2	9,00

Bolsa vacío gofrada cocción

Embossed vacuum bag boiling

Sac sous vide gaufré cuisson

Ref.	Medidas Size Dimensions	Unidades Units Unités	Euros
BVXC-200300	20 x 30 cm	100	33,00



Bolsa vacío galga 90

Gauge 90 vacuum bags

Sacs sous vide gale 90

Ref.	Medidas Size Dimensions	Unidades Units Unités	Euros
BV-140450	14 x 45 cm	1000	87,00
BV-150200	15 x 20 cm	1000	42,00
BV-150250	15 x 25 cm	1000	52,00
BV-175250	17,5 x 25 cm	1000	60,00
BV-180300	18 x 30 cm	1000	74,00
BV-200200	20 x 20 cm	1000	55,00
N BV-200250	20 x 25 cm	1000	69,00
BV-200300	20 x 30 cm	1000	83,00
N BV-200350	20 x 35 cm	1000	96,00
BV-200400	20 x 40 cm	1000	110,00
BV-250350	25 x 35 cm	1000	120,00
BV-300400	30 x 40 cm	500	83,00
BV-350500	35 x 50 cm	500	120,00
BV-350600	35 x 60 cm	500	144,00
N BV-400500	40 x 50 cm	500	138,00
N BV-400600	40 x 60 cm	500	165,00



Bolsas vacío plata y oro

Gold vacuum bags

Sacs sous vide d'or

Ref.	Medidas Size Dimensions	Tipo Type Type	Unidades Units Unités	Euros
BVPO-200300	20 x 30 cm	Oro	1000	219,00
BVPP-200300	20 x 30 cm	Plata	1000	192,00

Bolsa vacío galga 150

Gauge 150 vacuum bags

Sacs sous vide gale 150

Ref.	Medidas Size Dimensions	Unidades Units Unités	Euros
BVE-200300	20 x 30 cm	500	77,00
BVE-250350	25 x 35 cm	500	113,00
BVE-300400	30 x 40 cm	500	154,00
BVE-350450	35 x 45 cm	300	122,00
BVE-350600	35 x 60 cm	300	162,00



Bolsas vacío plata-transparente

Transparent-silver vacuum bags

Sacs sous vide argent transparent

Ref.	Medidas Size Dimensions	Unidades Units Unités	Euros
BVP-175250	17,5 x 25 cm	1000	94,00
BVP-175300	17,5 x 30 cm	1000	112,00
BVP-200250	20 x 25 cm	1000	107,00
BVP-200300	20 x 30 cm	1000	128,00

Bolsa vacío cocción a 121° C

Vacuum bag boiled at 121° C

Sacs sous vide cuisson à 121° C

Ref.	Medidas Size Dimensions	Unidades Units Unités	Euros
BVC-150200	15 x 20 cm	1000	72,00
BVC-185250	18,5 x 25 cm	1000	111,00
BVC-200300	20 x 30 cm	500	72,00
BVC-250350	25 x 35 cm	500	105,00
BVC-300400	30 x 40 cm	500	144,00
BVC-350500	35 x 50 cm	500	209,00



**Bolsa asado con asa para microondas
Troquel zipper**

Roasted microwave bag with handle
Troquel zipper

Sac rôti avec poignée micro-ondes
Fermeture éclair découpée

Ref.	Medidas Size Dimensions	Unidades Units Unités	Euros
BVA-1	30,5 x 25 + 7,5 cm	400	106,00
BVA-2	35 x 29 + 7,5 cm	400	124,00
BVA-3	35 x 29 + 10 cm	400	130,00



**Bolsa de pescado con asa
Troquel zipper**

Fish bag with handle
Troquel zipper

Sac à poisson avec poignée
Fermeture éclair découpée

Ref.	Medidas Size Dimensions	Unidades Units Unités	Euros
BVA-4	30 x 25 + 5 cm	500	175,00

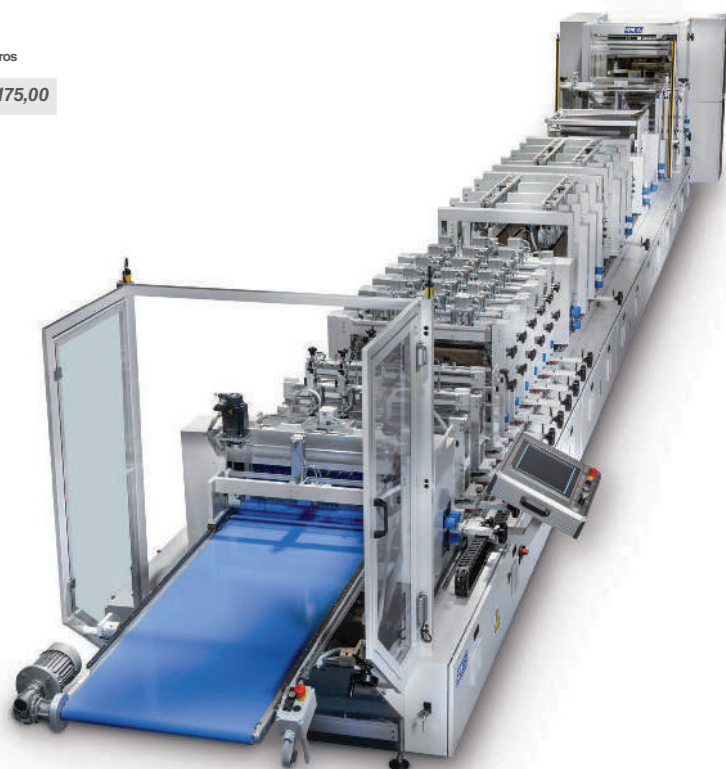

Nota: **Fabricamos bolsas a medida**



Termoselladora de barquetas 400 W
Incluye molde 95 x 135 y 135 x 195

Tray packaging thermo sealer 400 W
 Includes mold 95 x 135 and 135 x 195

Thermo machine à sceller de barquettes 400 W
Comprend moules 95 x 135 et 135 x 195

Ref.	Medidas Size Dimensions	Voltaje (V) Voltage (V) Voltage (V)	Euros
MT-152	18,7 x 40 cm	230	1090,00



Termoselladora de barquetas 600 W 1/4 GASTRONORM

Tray packaging thermo sealer 600 W GASTRONORM

Thermo machine à sceller de barquettes 600 W GASTRONORM

Ref.	Medidas Size Dimensions	Voltaje (V) Voltage (V) Voltage (V)	Euros
MT-192	22,8 x 49 cm	230	1470,00



Termoselladora de barquetas 1200 W 1/2 GASTRONORM

Tray packaging thermo sealer 1200 W GASTRONORM

Thermo machine à sceller de barquettes 1200 W GASTRONORM

Ref.	Medidas Size Dimensions	Voltaje (V) Voltage (V) Voltage (V)	Euros
MT-270	34,5 x 53,5 mm	230	3950,00



**Molde medidas
GN-1/4 barquetas para MT-192**

Mold sizes
GN-1/4 tray for MT-192

Moule mesures
GN-1/4 Barquettes for MT-192

Ref.	Euros
MTM-1/4	298,00

**Molde medidas
GN-1/2 barquetas para MT-270**

Mold sizes
GN-1/2 tray for MT-270

Moule mesures
GN-1/2 Barquettes for MT-270

Ref.	Euros
MTM-1/2	375,00

Bobina film termosellar

Termo packaging film roll

Boines film thermo-sceller

Ref.	Medidas Size Dimensions	Euros
MTB-15	15 x 300 cm	16,00
MTB-20	20 x 250 cm	15,00
MTB-27	27 x 400 cm	104,00



0

5

Secamanos, Dispensadores papel celulosa, Papel celulosa, Dosificadores jabón, Grifos - caño electrónico, Grifos ducha, Lavamanos, Portacuchillos - Papeleras, Esterilizadores de cuchillos, Contenedores plástico, Contenedores papeleras acero-inoxidable.

Hand dryer, Cellulose paper dispenser, Cellulose paper, Soap dispensers, Tap with electronic spout, Shower tap, Washbin, Knife holder - Waste baskets, Knives sterilizer, Plastic container, Stainless steel containers-bins.

Sèche-mains, Dispensateur papier cellulose, Papier cellulose, Doseurs de savon, Robinet électronique, Robinet douche, Lave - mains, Porte couteaux - Poubelles, stérilisateur de couteaux, Conteneurs plastique, Conteneur-poubelle acier inox.

101 - 120



Secamanos alta velocidad
Carcasa ABS blanco. Potencia 2050W. Velocidad 95 m/sg

High speed hand dryer
 White ABS frame. Power 2050W. Speed 95 m/sg.

Sèche-mains à grande vitesse
 Carcasse ABS blanc. Puissance 2050W. Vitesse 95 m/sg.

Ref.	Medidas Size Dimensions	Euros
SM-700	30 x 22 x 68,5 cm	765,00

SECAMANOS | HAND DRYER | SÈCHE MAINS



Secamanos
Control: célula de infrarrojos por proximidad. Caudal Aire : 225 m3/h. Interruptor aire: frío-caliente

Hand dryer
 Control: Infra-red cell proximity control. Air-flow: 225 m3/h. Switch: cold or hot air.

Sèche-mains
 Control: cellule infrarouges par proximité. Débit air: 225 m3/h.
 Interrupteur: air froid ou chaud.



Secamanos
Control: célula de infrarrojos por proximidad. Caudal aire: 270 m3/h. Carcasa: acero satinado

Hand dryer
 Infra-red cell proximity control. Air-flow: 270 m3/h. Frame: Satin finish steel

Sèche mains
 Contrôle: cellule infrarouges par proximité. Débit air: 270m3/h.
 Carcasse: acier satiné

Ref.	Medidas Size Dimensions	Voltaje (V) Voltage (V) Voltage (V)	Peso Weight Poids	Euros	Ref.	Medidas Size Dimensions	Voltaje (V) Voltage (V) Voltage (V)	Peso Weight Poids	Euros
SM-5	14 x 27 x 22 cm	220	2,4 kg	110,00	SM-6	20 x 26 x 21 cm	220	6,26 kg	230,00



Portabobinas plegable suelo acero-inox
Tipo de papel celulosa ref. PB-10

Stainless steel foldable standing paper reel holder
 Paper type : cellulose ref. PB-10

Porte bobines pliant sol acier inox
Type papier: cellulose réf. PB-10

Ref.	Medidas Size Dimensions	Euros
PB-1	40 x 45 x 83 cm	35,00



Portabobinas mural y sobremesa acero-inox
Tipo de papel : celulosa ref. PB-10

Stainless steel foldable standing paper reel holder
 Paper type: cellulose ref. PB-10

Porte bobines mural/dessus de table acier inox
Type papier: cellulose réf. PB-10

Ref.	Euros
PB-1-M	35,00



Portarrollos higiénico inox

Cellulose paper dispenser
 Stainless steel hygienic paper roll holder

Porte rouleaux hygiénique inox

Ref.	Diámetro Diameter Diamètre	Largo Long Longueur	Euros
PB-2	Ø 25 cm	11,5 cm	30,00



Portarrollos higiénico epoxi blanco
Eje 4,5. Tipo de papel : celulosa ref. PB-30

White epoxy hygienic paper roll holder
 Axis 4,5 cm. Paper type : cellulose ref. PB-30

Porte rouleaux hygiénique époxy blanc
Axe 4,5 cm. Type papier : cellulose réf. PB-30

Ref.	Diámetro Diameter Diamètre	Largo Long Longueur	Euros
PB-3	Ø 25 cm	11,5 cm	30,00



Portarrollos higiénico WC
Con visor.

Hygienic paper roll holder
 With visor.

Porte rouleaux hygiénique
Avec viseur.

Ref.	Medidasz Size Dimensions	Color Colour Couleur	Euros
PB-21	32,5 x 30,5 x 13 cm	○	17,50
PB-21N	32,5 x 30,5 x 13 cm	●	22,50



Dispensador de papel tipo mecha
Tipo de papel : celulosa ref. PB-50

Mecha paper dispenser
 Paper type : cellulose ref. PB-50

Distributeur de papier de type mèche
Type papier : cellulose réf. PB-50

Ref.	Medidas Size Dimensions	Euros
PB-9	26,5 x 35 cm	37,00



Dispensador papel tipo mecha
Con visor.

Mini mecha paper dispenser
 With viewer.

Dispensateur de papier de type mèche
Avec viseur

Ref.	Medidas Size Dimensions	Color Colour Couleur	Euros
PB-24	32 x 21 x 22 cm	○	23,00
PB-24N	32 x 21 x 22 cm	●	28,00



Dispensador papel tipo mecha
Tipo papel: ref. PB-50

Mecha paper dispenser

Distributeur de papier de type mèche
Type papier : cellulose ref. PB-50

Ref.	Diámetro Diameter Diamètre	Altura Height Hauteur	Euros
PB-12	Ø 32 cm	25 cm	130,00



Dispensador toallitas Z/Z acero inox
Tipo de papel : ref. PB-70

Z/Z folded towel dispenser
 Paper type : ref. PB-70

Distributeur lingettes Z/Z
Type papier: ref. PB-70

Ref.	Medidas Size Dimensions	Euros
PB-8	33 x 26,5 x 12 cm	39,00



Dispensador toallitas Z/Z epoxi blanco
Tipo de papel : ref. PB-70

Z/Z folded towel dispenser
 Paper type : ref. PB-70

Distributeur lingettes Z/Z
Type papier : ref. PB-70

Ref.	Medidas Size Dimensions	Euros
PB-7	31 x 26,5 x 12 cm	39,00



Dispensador toallitas Z/Z ABS
Con visor.

Z/Z towels dispenser ABS
 With viewer.

Dispensateur lingettes ZZ ABS
Avec viseur.

Ref.	Medidas Size Dimensions	Color Colour Couleur	Euros
PB-22	37 x 27,5 x 13,5 cm	○	17,00
PB-22N	37 x 27,5 x 13,5 cm	●	22,00



Dispensador de papel tipo mecha mini
Con visor

Mini mecha paper dispenser
 With viewer

Dispensateur de papier de type mèche mini
Avec viseur

Ref.	Medidas Size Dimensions	Color Colour Couleur	Euros
PB-23	14 x 16 x 29 cm	○	17,50
PB-23N	14 x 16 x 29 cm	●	21,00



Dispensador de papel tipo mecha mini
Tipo de papel : celulosa ref. PB-40

Mini mecha paper dispenser
 Paper type : cellulose ref. PB-40

Distributeur de papier de type mèche
Type papier : cellulose réf. PB-40

Ref.	Medidas Size Dimensions	Euros
PB-11	15 x 27 cm	33,00

PAPEL CELULOSA | CELLULOSE PAPER | PAPIER CELLULOSE



Bobina mecha 2 capas

Roll of 2-layer cellulose paper

Bobine cellulose 2 épaisseurs

Ref.	Largo Long Longueur	Unidades Units Unités	Euros
PB-40	65 m	12	30,00
PB-50	180 m	6	32,00

Bobina celulosa industrial 2 capas

Roll of 2-layer industrial paper

Rouleau cellulose industrielle 2 épaisseurs

Ref.	Largo Long Longueur	Unidades Units Unités	Euros
PB-10	500 m	2	35,00

Rollo papel higiénico dos capas

Reel of 2-layer hygienic paper

Bobine cellulose hygiénique 2 épaisseursZ

Ref.	Largo Long Longueur	Unidades Units Unités	Euros
PB-30	150 m	18	35,00

Totallitas Z/Z
200 uds x 20 paquetes

Z/Z folded towel
 200 units x 20 packs

Lingettes Z/Z
200 units x 20 paquet

Ref.	Euros
PB-70	34,00



Dosificador de jabón luxe

Deluxe soap dispensers

Doseur de savon luxe

Ref.	Medidas Size Dimensions	Capacidad Capacity Capacité	Euros
D-1	12 x 11 cm	1 l	19,00



Dosificador de jabón

Soap dispenser

Doseur de savon

Ref.	Diámetro Diameter Diamètre	Altura Height Hauteur	Capacidad Capacity Capacité	Euros
D-2	Ø 13 cm	24 cm	2 l	22,00



**Dosificador de jabón
Color blanco**

Soap dispenser
White colour

*Doseur de savon
Couleur blanc*

Ref.	Medidas Size Dimensions	Capacidad Capacity Capacité	Euros
D-4-B	9 x 10 x 22,5 cm	1 l	22,00



Dosificador jabón cromado

Soap dispenser chrome

Doseur de savon chromé

Ref.	Medidas Size Dimensions	Capacidad Capacity Capacité	Euros
D-4-C	9 x 10 x 22,5 cm	1 l	33,00



**Dosificador jabón
Color blanco o negro. Con visor**

Soap dispenser
White or black colour. With viewer

*Doseur de savon
Couleur blanc ou noir. Avec viseur*

Ref.	Medidas Size Dimensions	Capacidad Capacity Capacité	Euros
D-7	13 x 9,5 x 21,5 cm	0,8 l	15,50
D-7-N	13 x 9,5 x 21,5 cm	0,8 l	20,00



Dosificador jabón

Soap dispenser

Doseur de savon

Ref.	Medidas Size Dimensions	Capacidad Capacity Capacité	Euros
D-8	11,6 x 5,8 x 17,5 cm	0,8 l	41,00



Dosificador de jabón electrónico
Color blanco

Electronic soap dispenser
White colour

Doseur de savon
Couleur blanc

Ref.	Medidas Size Dimensions	Capacidad Capacity Capacité	Euros
D-11	14 x 11,8 x 23,4 cm	1 l	44,00

GRIFO-CAÑO ELECTRÓNICO | TAP WITH ELECTRONIC SPOUT | ROBINET ÉLECTRONIQUE



Grifo con kit electrónico
Sensor infrarrojo.

Tap with electronic kit
Infrared sensor.

Robinet avec kit électronique
Senseur infrarouge.

Ref.	Voltaje (V) Voltage (V) Voltage (V)	Tensión de trabajo (V) Working voltage (V) Tension de travail (V)	Euros
LM-10	220	12	240,00

Grifo con kit electrónico pilas
Grifo un agua. Sensor infrarrojo. 4 pilas AA de 1,5V

Tap with battery powered electronic kit
Single water tap. Infrared sensor. Four 1,5V AA batteries.

Robinet avec kit électronique à piles
Robinet 1 eau. Senseur infrarouge. 4 piles AA de 1,5V

Ref.	Tensión de trabajo (V) Working voltage (V) Tension de travail (V)	Euros
LM-10-P	6	255,00





Caño giratorio eco

Eco swivel spout

Bec giratoire éco

Ref.	Euros
LM-1-2	24,00

Válvula mezcladora 2 aguas

Double water mixer valve

Valve mélangeuse 2 eaux

Ref.	Euros
LM-1-1	24,00

Caño giratorio

Swivel spout

Bec giratoire

Ref.	Euros
LM-1-3	45,00

Pedal 1 agua

Single water pedal

Pédale 1 eau

Ref.	Euros
LM-2-1	47,00

Pedal 2 aguas

Double water pedal

Pédale 2 eaux

Ref.	Euros
LM-2-2	82,00

Pulsador temporizador

Press button timer

Bouton poussoir minuterie

Ref.	Euros
LM-1-1	34,00



**Grifo ducha extensible de un agua.
Piña blanca.**

Single extendable shower tap.
White shower head

*Robinet douche extensible une eau.
Pomme blanche.*

Ref.	Euros
LM-21	190,00



**Grifo ducha extensible de dos aguas.
Piña blanca.**

Double extendable shower tap.
White shower head

*Robinet douche extensible deux eaux.
Pomme blanche.*

Ref.	Euros
LM-22	207,00



**Grifo ducha extensible de un agua
Piña negra**

Single extendable shower tap
White shower head

*Robinet douche extensible une eau
Pomme noire.*

Ref.	Euros
LM-23	199,00



Mural dos aguas

Double water wall tap

Robinet mural deux eaux

Ref.	Euros
LM-26	57,00

**Grifo ducha extensible de dos aguas
Piña negra**

Double extendable shower tap
White shower head

*Robinet douche extensible deux eaux.
Pomme noire*

Ref.	Euros
LM-24	211,00



**Caño giratorio con monomando codo
Acoplable para grifos ducheta**

Single lever mixer wall tap with swivel spout

Robinet mural à bec giratoire mitigeur

Ref.	Euros
LM-27	190,00

Flexo ducheta, 120 cm

Hose, 120 cm

Tuyau, 120 cm

Ref.	Para For Pour	Euros
LM-21-2	LM-21, LM-22	22,00

Flexo ducheta, 120 cm, transparente

Hose, 120 cm, transparent

Tuyau, 120 cm, transparent

Ref.	Para For Pour	Euros
LM-23-2	LM-23, LM-24	22,00

Soporte pared y piña

Wall holder and head shower

Support de mur et robinet de douche

Ref.	Para For Pour	Euros
LM-21-3	LM-21, LM-22, LM-23, LM-24	31,00

Muelle para flexo ducha

Spring for hose

Ressort pour tuyau

Ref.	Para For Pour	Euros
LM-21-4	LM-21, LM-22, LM-23, LM-24	33,00

Piña ducheta para ref. LM-21 y LM-22

Shower head adaptable to ref. LM-21 and LM-22

Pomme de douche pour ref. LM-21 et LM-22

Ref.	Euros
LM-21-1	73,00

Piña ducheta para ref. L-23 y LM-24

Shower head for ref. LM-23 and LM-24

Pomme de douche pour réf. LM-23 et LM-24

Ref.	Euros
LM-23-1	75,00

Caño giratorio acoplable para grifos ducha.

Revolving spout can be fitted to shower taps

Bec giratoire adaptable pour robinets douche

Ref.	Euros
LM-25	75,00

LAVAMANOS | WASHBASIN | LAVE-MAINS

Lavamanos inox con pulsador de pie Mezclador agua fría y caliente. Caño giratorio. Alto mas 30 cm de PETO

Stainless steel washbasin with foot operated push button
Cold and hot water mixer. Swivel spout.

*Lave-mains inox avec bouton-poussoir actionné par le pied
Mélangeur eau froide et chaude. Bec giratoire.*

Ref.	Medidas Size Dimensions	Euros
LM-1	45 x 45 x 86 cm	398,00



**Lavamanos inox con pedal
Mezclador agua fría y caliente. Caño fijo.**

Stainless steel washbasin with pedal
Cold and hot water mixer. Fixed spout.

*Lave-mains inox avec pédale
Mélangeur eau froide et chaude. Bec fixe.*

Ref.	Medidas Size Dimensions	Euros
LM-2	45 x 45 x 85 cm	427,00

**Lavamanos inox con 2 pedales
Mezclador agua fría y caliente.**

Stainless steel washbasin with 2 pedals
Cold and hot water mixer.

*Lave-mains inox. avec 2 pédale
Mélangeur eau froide et chaude*

Ref.	Medidas Size Dimensions	Euros
LM-2-P	45 x 45 x 85 cm	452,00



**Lavamanos inox mural
Con mezclador. Pulsador de rodilla. Caño giratorio**

Wall stainless steel washbasin
With mixer. Knee push button. Swivel spout.

*Lave-mains inox mural
Avec mixeur. Bouton poussoir genou. Bec
giratoire.*

Ref.	Medidas Size Dimensions	Euros
LM-4	40 x 30 x 20 cm	232,00

Peto para ref. LM-4

Guard for ref. LM-4

Plastron pour réf. LM-4

Ref.	Euros
LMP-4	32,00



**Lavamanos inox mural
Pulsador de rodilla. Mezclador agua fría y
caliente. Caño fijo.**

Wall stainless steel washbasin
Knee push button. Cold and hot water
mixer. Fixed spout.

*Lave-mains inox mural avec mélangeur
Bouton poussoir genou. Mélangeur eau
froide et chaude. Bec fixe.*

Ref.	Medidas Size Dimensions	Euros
LM-5	45 x 45 x 20 cm	265,00

Peto para ref. LM-2, LM-5

Guard for ref. LM-2, LM-5

Plastron pour réf. LM-2, LM-5

Ref.	Euros
LMP-5	32,00

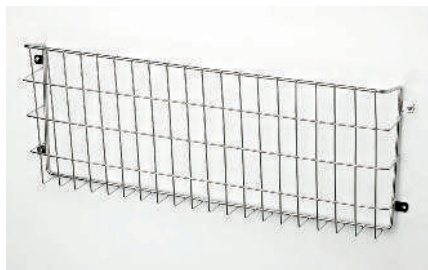

Papelera rejilla, acero-inox

Grille waste paper basket, stainless steel

Poubelle rejilla, acier-inox

Ref.	Medidas Size Dimensions	Euros
A-95	60 x 7,5 x 22 cm	35,00



**Portacuchillos protegido, acero-inox
Con tres ranuras para cuchillos y chaira
ovalada-redonda**

Encased knife holder, stainless steel
Three grooves for knives and oval
professional sharpener

*Porte couteaux et fusil ovale rond, acier inox
Avec trois rainures pour couteaux et fusil
ovale rond*

Papelera, acero inox

Waste paper bin, stainless steel

Poubelle, acier inox

Ref.	Medidas Size Dimensions	Euros	Ref.	Medidas Size Dimensions	Euros
EC-10	38 x 9 x 38 cm	105,00	A-90	33 x 13 x 27,5 cm	77,00



**Esterilizador de cuchillos por ozono
Acero-inox, Duración aconsejable 15 minutos**

Ozone Knife steriliser
Stainless steel, Recommended time 15 minutes

*Stérilisateur de couteaux par ozono
Acier inox, recommandé 15 minutes*

Ref.	Medidas Size Dimensions	Voltaje (V) Voltage (V) Voltage (V)	Euros
EC-1	60 x 10 x 35 cm	220 V	337,00



Esterilizador de cuchillos por agua caliente
De acero-inox, resistencia de 750 W estanco y una temperatura aconsejable de 82°.

Hot water knife steriliser
Stainless steel, resistance a 750 W watertight and a recommended temperature of 82°.

Stérilisateur de couteaux par eau chaude
Acier inox, résistance 750 W étanche, température recommandée 82°.

Ref.	Medidas Size Dimensions	Voltaje (V) Voltage (V) Voltage (V)	Euros
EC-5-45	35 x 10 x 45 cm	220	505,00

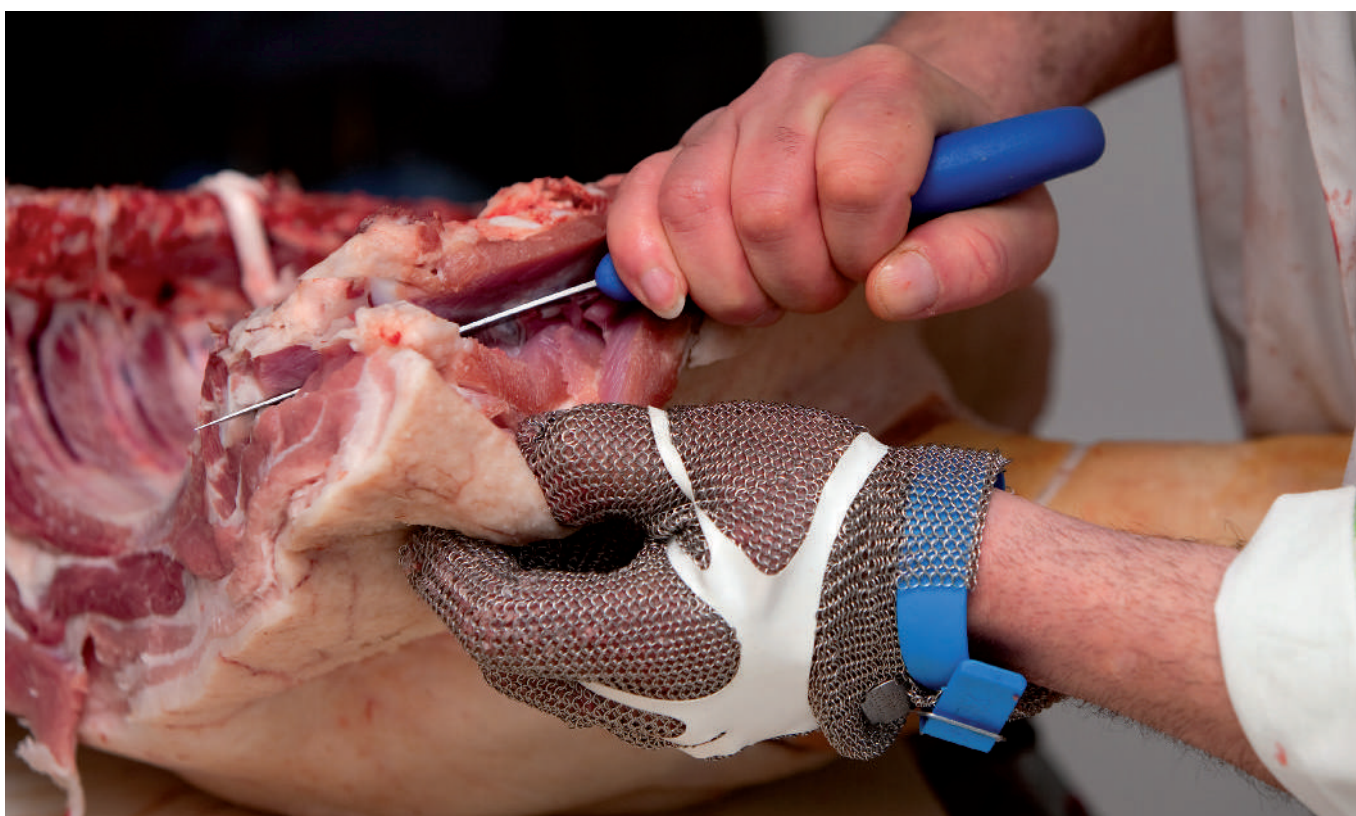



**Armario esterilizador por lámpara de ozono
2 barras de imán. Puerta de metacrilato transparente para poder acceder totalmente a su interior, acero inox**

Ozone lamp steriliser cabinet
Two-bar magnet. Transparent methacrylate door for easy access, stainless steel.

*Armoire stérilisation par lampe d'ozone
2 barre aimant. Porte en méthacrylate transparent pour pouvoir accéder complètement à l'intérieur, acier inox.*

Ref.	Medidas Size Dimensions	Voltaje (V) Voltage (V) Voltage (V)	Euros
EC-35	35 x 58 x 12 cm	220	460,00

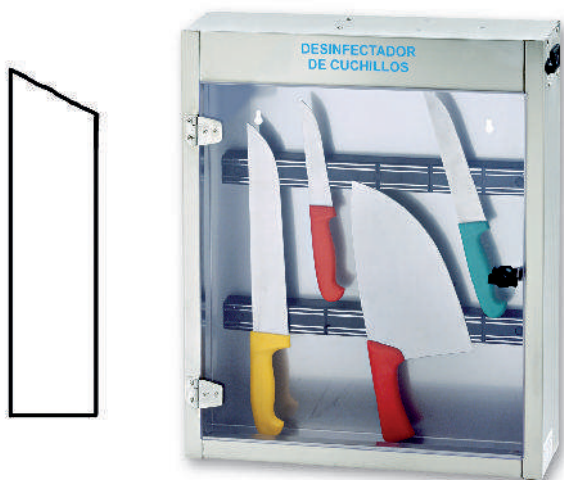

**Armario esterilizador por lámpara de ozono
2 barras de imán. Puerta de metacrilato para poder acceder totalmente a su interior, acero-inox.**

Techo inclinado

Ozone lamp steriliser cabinet
Two-bar magnet. Transparent methacrylate door for easy access, stainless steel.

Sloping top

*Armoire stérilisation par lampe d'ozone
2 barre aimant. Porte en méthacrylate transparent pour pouvoir accéder complètement à l'intérieur, acier-inox.*

Toit incliné

Ref.	Medidas Size Dimensions	Voltaje (V) Voltage (V) Voltage (V)	Euros
EC-55	47 x 58 x 12 cm	220	550,00



**Armario esterilizador por lámpara de ozono
4 barras de imán. Puerta de metacrilato transparente para poder acceder totalmente a su interior, acero inox.**

Techo inclinado

Ozone lamp steriliser cabinet
4-bar magnet. 2 transparent methacrylate door for easy access, stainless steel.

Sloping top

*Armoire stérilisation par lampe d'ozone
4 barre aimant. 2 porte en méthacrylate transparent pou pouvoir accéder complètement à l'intérieur, acier-inox*

Toit incliné

Ref.	Medidas Size Dimensions	Voltaje (V) Voltage (V) Voltage (V)	Euros
EC-105	100 x 59 x 12 cm	220	792,00



Armario esterilizador ultravioleta
Soporte inox 10 cuchillos. Puerta: plexiglas transparente ahumado. Lámpara: UVC 15W. Temporizador: reloj 0 a 2 horas. Duración aconsejada 1h 30. Acero-inox.

UUV steriliser cabinet
 Stand: stainless steel 10 knives. Door: transparent smoked Plexiglas.
 Lamp: UVC 15W. Timer: 0 to 2 hrs clock. Recommended duration: 1h 30. Stainless steel.

Armoire stérilisatrice ultraviolette
Support: inox 10 couteaux. Porte: plexiglas transparent teinté.
Lampe: UVC 15W. Minuterie: horloge 0 à 2h. Durée recommandée: 1h 30. Acier-inox

Ref.	Medidas Size Dimensions	Voltaje (V) Voltage (V) Voltage (V)	Euros
ECU-25	35 x 12,5 x 57,5 cm	220	310,00



Armario esterilizador ultravioleta
Soporte: inox 20 cuchillos. Puerta: plexiglas transparente ahumado. Lámpara: UVC 15W. Temporizador: reloj 0 a 2h. Duración aconsejada: 1h 30. Acero-inox.

UV steriliser cabinet
 Stand: stainless steel 20 knives. Door: transparent smoked plexiglas.
 Lamp: UVC 15W. Timer: 0 to 2 h clock. Recommended duration: 1h 30. Stainless steel.

Armoire stérilisatrice ultraviolette
Support: inox 20 couteaux. Porte: plexiglas transparent teinté.
Lampe: UVC 15W. Minuterie : horloge 0 à 2h. Durée recommandée 1h 30. Acier Inox.

Ref.	Medidas Size Dimensions	Voltaje (V) Voltage (V) Voltage (V)	Euros
EC-50	44 x 12,5 x 57,5 cm	220	360,00

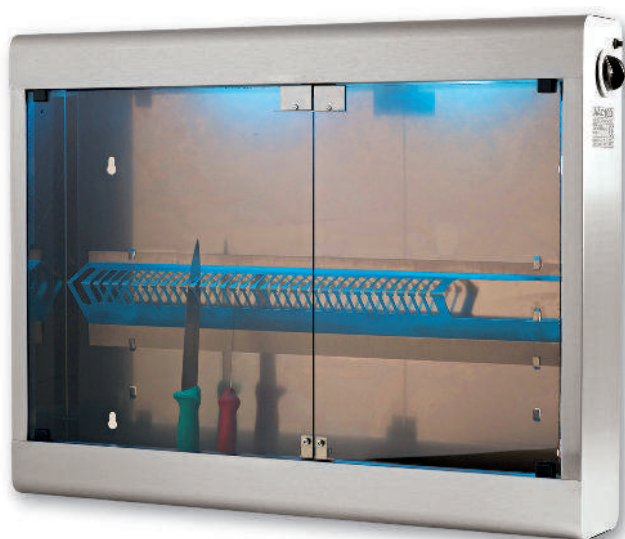

Armario esterilizador ultravioleta
Soporte: inox 30 cuchillos. Puerta: plexiglas transparente ahumado. Lámpara 2x15W. Temporizador: reloj 0 a 2 horas. Duración aconsejada: 1h 30. Acero-inox.

UUV steriliser cabinet
 Stand: stainless steel 30 knives. Door: transparent smoked plexiglas.
 Lamp: 2x15W. Timer: 0 to 2 h clock. Recommended duration: 1h 30. Stainless steel.

Armoire stérilisatrice ultraviolette
Support: inox 30 couteaux. Porte: plexiglas transparent teinté.
Lampe: 2x15W. Minuterie: horloge 0 à 2h. Durée recommandée: 1h 30. Acier inox.

Ref.	Medidas Size Dimensions	Voltaje (V) Voltage (V) Voltage (V)	Euros
ECU-100	75 x 12,5 x 57,5 cm	220	595,00



**Carro contenedor de basura
Tapa abatible con pedal.**

Two-wheel mobile garbage bin
Pedal lift-top

*Chariot conteneur de déchets
Couvercle rabattable avec pédale.*

Ref.	Medidas Size Dimensions	Capacidad Capacity Capacité	Color Colour Couleur	Euros
W-60	50,5 x 44,5 x 70 cm	60 l	○ ● ●	99,00



**Carro contenedor de basura
Tapa abatible con pedal.**

Two-wheel mobile garbage bin
Pedal lift top.

*Chariot conteneur de déchets
Couvercle rabattable avec pédale.*

Ref.	Medidas Size Dimensions	Capacidad Capacity Capacité	Color Colour Couleur	Euros
W-80	50,5 x 44,5 x 84,5 cm	80 l	● ●	99,00



**Carro contenedor de basura
Tapa abatible con pedal.**

Two-wheel mobile garbage bin
Pedal-lift top.

*Chariot conteneur de déchets
Couvercle rabattable avec pédale.*



Ref.	Medidas Size Dimensions	Capacidad Capacity Capacité	Color Colour Couleur	Euros
W-120	55 x 58 x 93 cm	120	○ ● ● ● ● ● ● ●	99,00



**Carro contenedor de basura
Tapa abatible con pedal.**

Two-wheel mobile garbage bin
Pedal-lift top.

*Chariot conteneur de déchets
Couvercle rabattable avec pédale.*

Ref.	Medidas Size Dimensions	Capacidad Capacity Capacité	Color Colour Couleur	Euros
W-240	74 x 58 x 107 cm	240 l	● ●	130,00



**Cubo de basura con pedal
Con aro sujeta bolsas. 28 l**

Pedal bin
With hoop holds bags. 28 l

*Poubelle à pédale
Avec cerceau détient des sacs. 28 l*

Ref.	Medidas Size Dimensions	Color Colour Couleur	Euros
W-28	33 x 35 x 49,5 cm	○	26,00



**Carro contenedor de basura
Tapa abatible con pedal.**

Two-wheel mobile garbage bin
Pedal lift top.

*Chariot conteneur de déchets
Couvercle rabattable avec pédale.*

Ref.	Medidas Size Dimensions	Capacidad Capacity Capacité	Color Colour Couleur	Euros
W-81	55 x 58 x 93 cm	80 l	○	99,00

CONTENEDORES - PAPELERAS ACERO-INOXIDABLE | BINS - STAINLESS STEEL CONTAINERS-BINS | CONTENEUR-POUBELLE ACIER INOX



**Papelera basculante acero-inox
Tapa basculante. Parte superior extraíble**

Stainless steel container
Lift-top. Removable upper part

*Conteneur acier inox
Couvercle basculant. Partie supérieure amovible*

Ref.	Medidas Size Dimensions	Capacidad Capacity Capacité	Euros
WI-35	30 x 20 x 70 cm	35 l	225,00



Papelera basculante acero-inox
Tapa basculante. Parte superior extraíble

Stainless steel container
 Lift-top. Removable upper part

Conteneur acier inox
Couvercle basculant. Partie supérieure amovible

Ref.	Medidas Size Dimensions	Capacidad Capacity Capacité	Euros
WI-75	40 x 30 x 90 cm	75 l	248,00



Contenedor acero-inox
Tapa con pedal. Puerta frontal para extraer bolsa. Asa H72

Stainless steel container
 Pedal-lift top. Frontal door for bag removal. Handle H 72

Conteneur acier inox
Couvercle avec pédale. Porte avant pour extraire le sac. Asa H 72

Ref.	Medidas Size Dimensions	Capacidad Capacity Capacité	Euros
WI-70	46 x 36 x 72 cm	70 l	340,00



Contenedor acero-inox
Tapa con pedal. Puerta frontal para extraer bolsa. Asa H92

Stainless steel container
 Pedal-lift top. Frontal door for bag removal. Handle H 92

Conteneur acier inox
Couvercle avec pédale. Porte avant pour extraire le sac. Asa H 92

Ref.	Medidas Size Dimensions	Capacidad Capacity Capacité	Euros
WI-90	46 x 36 x 92 cm	90 l	393,00



Contenedor acero-inox
Tapa con pedal

Stainless steel container
 Pedal-lift top

Conteneur acier inox
Couvercle avec pedale

Ref.	Díámetro Diameter Diamètre	Altura Height Hauteur	Capacidad Capacity Capacité	Euros
WI-110	Ø 40 cm	86 cm	110 l	250,00



Contenedor acero-inox
Tapa con pedal. Tapa extraíble

Stainless steel container
 Pedal-lift top. Removable top

Conteneur acier inox
Couvercle avec pédale. Couvercle amovible

Ref.	Díámetro Diameter Diamètre	Altura Height Hauteur	Capacidad Capacity Capacité	Euros
WI-60	Ø 40 cm	60 cm	60 l	306,00



Indicadores de turno, Expendedores de tickets, Impresora de tickets, Rollo tickets, Exterminadores de insectos, Detector contador billetes - monedas, Reloj-temperatura

Queue indicators, Ticket dispenser, Tickets printer, Ticket roll, Insect exterminator, Counter detector bill - coin, Clock - temperature

Indicateur de numero, Dispensateu tickets, Imprimante tickets, Rouleaux de tickets, Exterminateur d'insectes, Compteur détecteur billets - monnaie, Horloge - température

121 - 134



Indicador de turno
Visor de dos dígitos con mando a distancia.

Queue indicator
Two-digit screen with remote control.

Indicateur de numéro
Visseur à deux chiffres avec commande à distance

Ref.	Medidas Size Dimensions	Altura dígitos (cm) Digits height (cm) Hauteur chiffres (cm)	Voltaje (V) Voltage (V) Voltage (V)	Euros
IT-5-MD	30 x 26 cm	13	220	243,00



Indicador de turno
Visor de dos dígitos y mando a distancia con visor.

Queue indicator
Two-digit screen with remote control with screen.

Indicateur de numéro
Visseur à deux chiffres et commande à distance avec viseur

Ref.	Medidas Size Dimensions	Altura dígitos (cm) Digits height (cm) Hauteur chiffres (cm)	Voltaje (V) Voltage (V) Voltage (V)	Euros
IT-5-MDV	30 x 32 cm	13	220	270,00



Indicador de turno
Visor de dos dígitos con mando con cable.

Queue indicator
Two-digit screen with control pad with cable

Indicateur de numéro
Visseur à deux chiffres et commande avec fil

Ref.	Medidas Size Dimensions	Altura dígitos (cm) Digits height (cm) Hauteur chiffres (cm)	Voltaje (V) Voltage (V) Voltage (V)	Euros
IT-6	34,5 x 24 cm	12,5	220V	278,00

Indicador de turno
Visor de dos dígitos con mando con cable estanco



Queue indicator
Two-digit viewfinder with remote control with waterproof cable

Indicateur de numéro
Visseur à deux chiffres avec télécommande avec câble étanche

Ref.	Medidas Size Dimensions	Altura dígitos (cm) Digits height (cm) Hauteur chiffres (cm)	Voltaje (V) Voltage (V) Voltage (V)	Euros
IT-6-E	34,5 x 24 cm	12,5	220V	294,00

Indicador de turno
Visor de dos dígitos con mando con cable. Conexión balanzas Dibal



Queue indicator
Two-digit screen with control pad with cable. Dibal balance connection

Indicateur de numéro
Visseur à deux chiffres et commande avec fil. Connexion balance Dibal

Ref.	Medidas Size Dimensions	Altura dígitos (cm) Digits height (cm) Hauteur chiffres (cm)	Voltaje (V) Voltage (V) Voltage (V)	Euros
IT-6-B	34,5 x 24 cm	12,5	220V	263,00



Indicador de turno
Visor dos dígitos con mando a distancia

Queue indicator
Two-digit screen with remote control

Indicateur de numéro
Viseur à deux chiffres et commande à distance

Ref.	Medidas Size Dimensions	Altura dígitos (cm) Digits height (cm) Hauteur chiffres (cm)	Voltaje (V) Voltage (V) Voltage (V)	Euros
IT-6-MD	34,5 x 24 cm	12,5	220	306,00



Indicador de turno
Visor dos dígitos con cable y visor, adelanta, retrocede

Queue indicator
Two-digit screen with remote control pad with cable and screen, goes forward and back and can select numbers

Indicateur de numéro
Viseur à deux chiffres et commande à distance avec fil et viseur, avance et recule et sélection numérique

Ref.	Medidas Size Dimensions	Altura dígitos (cm) Digits height (cm) Hauteur chiffres (cm)	Voltaje (V) Voltage (V) Voltage (V)	Euros
IT-6-X	34,5 x 24 cm	12,5	220	444,00



Indicador de turno
Batería 12v. Visor dos dígitos. Mando a distancia

Queue indicator
Battery 12V. Two digit-screen. Remote control

Indicateur de numéro
Viseur à deux chiffres batterie 12 V télécommande.

Ref.	Medidas Size Dimensions	Voltaje (V) Voltage (V) Voltage (V)	Altura dígitos (cm) Digits height (cm) Hauteur chiffres (cm)	Euros
IT-7-MD	28 x 24,5 cm	220V/12V	15	243,00



Indicador de turno
Visor dos dígitos. Mando con cable.

Queue indicator
Two-digit screen with control pad with cable

Indicateur de numéro
Viseur à deux chiffres et commande avec fil

Ref.	Medidas Size Dimensions	Altura dígitos (cm) Digits height (cm) Hauteur chiffres (cm)	Voltaje (V) Voltage (V) Voltage (V)	Euros
IT-8	24,5 x 15 cm	9,5	220	220,00



Indicador de turno
Visor dos dígitos. Mando a distancia.

Queue indicators
2 digits screen remote control

Indicateur de numéro
Viseur à deux chiffres. Télécommande.

Ref.	Medidas Size Dimensions	Altura dígitos (cm) Digits height (cm) Hauteur chiffres (cm)	Voltaje (V) Voltage (V) Voltage (V)	Euros
IT-8-MD	24,5 x 15 cm	9.50	220	235,00

Indicador de turno. Visor 2 dígitos. Mando a distancia.
Kit: pantalla + mando + dispensador rojo + 1 rollo + cartel



Queue indicators. Two digit screen remote control.
Kit: screen + control + red dispenser + 1 roll + poster

Indicateur de numéro. Viseur à deux chiffres. Télécommande.
Kit: écran + contrôle + distributeur rouge + 1 rouleau + poster



Ref.	Medidas Size Dimensions	Altura dígitos (cm) Digits height (cm) Hauteur chiffres (cm)	Voltaje (V) Voltage (V) Voltage (V)	Euros
IT-9-MD	30 x 20 cm	10	220 V	210,00

Indicador de turno.
Visor 3 dígitos, mando con cable

Queue indicator
Three-digit screen, control pad with cable.

Indicateur de numéro
Viseur 3 chiffres, commande avec fil



Ref.	Medidas Size Dimensions	Altura dígitos (cm) Digits height (cm) Hauteur chiffres (cm)	Voltaje (V) Voltage (V) Voltage (V)	Euros
IT-4	34,5 x 24 cm	12.5	220	357,00

Indicador de turno
Visor 3 dígitos con mando a distancia

Queue indicator
3 digits screen with remote control

Indicateur de numéro
Viseur 3 chiffres avec télécommande



Ref.	Medidas Size Dimensions	Altura dígitos (cm) Digits height (cm) Hauteur chiffres (cm)	Voltaje (V) Voltage (V) Voltage (V)	Euros
IT-4-MD	34,5 x 24 cm	12.5	220	432,00



Indicador de turno
Visor 3 dígitos, mando con cable y visor. Adelanta, retrocede y selección numérico

Queue indicator
 Three digits screen, control cable pad, goes back and forward.

Indicateur de numéro
Viseur 3 chiffres, commande avec fil, avance et recule

Ref.	Medidas Size Dimensions	Altura dígitos (cm) Digits height (cm) Hauteur chiffres (cm)	Voltaje (V) Voltage (V) Voltage (V)	Euros
IT-4-X	34,5 x 24 cm	12,5	220	584,00



Indicador de turno
Visor 2 dígitos + 1 dígito punto atención. Mando con visor.

Queue indicator
 2+1 digit screen. Control pad with screen.

Indicateur de numéro
Viseur 2 chiffres avec lieu d'attention

Ref.	Medidas Size Dimensions	Altura dígitos (cm) Digits height (cm) Hauteur chiffres (cm)	Voltaje (V) Voltage (V) Voltage (V)	Euros
IT-10	34,5 x 24 cm	12,95 / 9,5	220	905,00



Mando con visor para ref. IT-10

Control pad with screen for ref. IT-10

Commande avec viseur pour réf. IT-10

Ref.	Euros
IT-10-1	105,00



Indicador de turno con punto de atención
Visor 3+1 dígitos. Mando con visor. Base telefónica.

Queue indicator displaying free counter number
 3+1 digit screen. Control pad with screen.

Écran indicateur de numéro avec lieu d'attention
Viseur à 3+1 chiffres.

Ref.	Medidas Size Dimensions	Altura dígitos (cm) Digits height (cm) Hauteur chiffres (cm)	Voltaje (V) Voltage (V) Voltage (V)	Euros
IT-11	34,5 x 24 cm	12,5 x 9,5	220	1015,00



Mando con visor para ref. IT-11

Control pad with screen for ref. IT-11

Commande avec viseur pour réf. IT-11

Ref.	Euros
IT-11-1	108,00



Indicador de turno
Panel 3 secciones. Visor 2+4 dígitos. Mando con cable.

Queue indicator
3-section panel. 2+4 digits screen. Control pad with cable.

Indicateur de numéro
Panneau 3 sections. Viseur à 2+4 chiffres. Commande avec fil.

Ref.	Medidas Size Dimensions	Altura dígitos (cm) Digits height (cm) Hauteur chiffres (cm)	Voltaje (V) Voltage (V) Voltage (V)	Euros
IT-30	54 x 40 cm	12,5 + 9,5	220	727,00



Indicador de turno
Panel de 3 secciones. Visor 2+4 dígitos. Mando a distancia.

Queue indicator
Panel 3 secciones. 2+4 digit screen. Remote control.

Panel 3 sections. Viseur à 2+4 chiffres. Commande à distance.

Ref.	Medidas Size Dimensions	Altura dígitos (cm) Digits height (cm) Hauteur chiffres (cm)	Voltaje (V) Voltage (V) Voltage (V)	Euros
IT-30-MD	54 x 40 cm	12,5 x 9,5	220	788,00

INDICADOR TEMPERATURA | TEMPERATURE WARNING | INDICATEUR DE TEMPÉRATURE



Panel temperatura / humedad
Dígitos 9,5 cm

Temperature warning
Temperature / humidity noticeboard. Digits 9,5 cm

Indicateur de température
Tableau de température / humidité. Chiffres 9,5 cm.

Ref.	Medidas Size Dimensions	Euros
ITH-95	7 x 32 x 48 cm	840,00



Reloj - temperatura
Carcasa metálica. 4 dígitos 12,5 rojos. Mando a distancia

Clock - temperature
Metal housing. 4 red digits 12.5. Remote control

Horloge - température
Boîtier en métal. 4 chiffres rouges 12.5. Télécommande

Ref.	Medidas Size Dimensions	Euros
ITR-125	63,5 x 30,5 cm	785,00



**Columna epoxi negro para expendedor ET-1
Incluye cartel.**

Black epoxy stand for ET-1 ticket dispenser

Colonne époxy noir pour dispensateur ET-1

Ref.	Euros
ET-15	143,00



**Expendedor impresora térmica
Ticket hasta 4 secciones**

Thermal printer dispenser
Ticket up to 4 sections

Dispensateur d'imprimante thermique
Ticket jusqu'à 4 sections

Ref.	Euros
ET-100	1350,00



Expendedor de tickets

Ticket dispenser

Dispensateur tickets

Ref.	Color Colour Couleur	Euros
ET-1-A	●	19,00
ET-1-AZ	●	19,00
ET-1-B	○	19,00
ET-1-N	●	19,00
ET-1-R	●	19,00
ET-1-V	●	19,00



Soporte pie expendedor ET-100

Food stand dispenser ET-100

Support pied dispensateur ET-100

Ref.	Euros
ET-100-S	210,00



Soporte pared expendedor ET-100

Wall stand dispenser ET-100

Support mural dispensateur ET-100

Ref.	Euros
ET-100-P	103,00

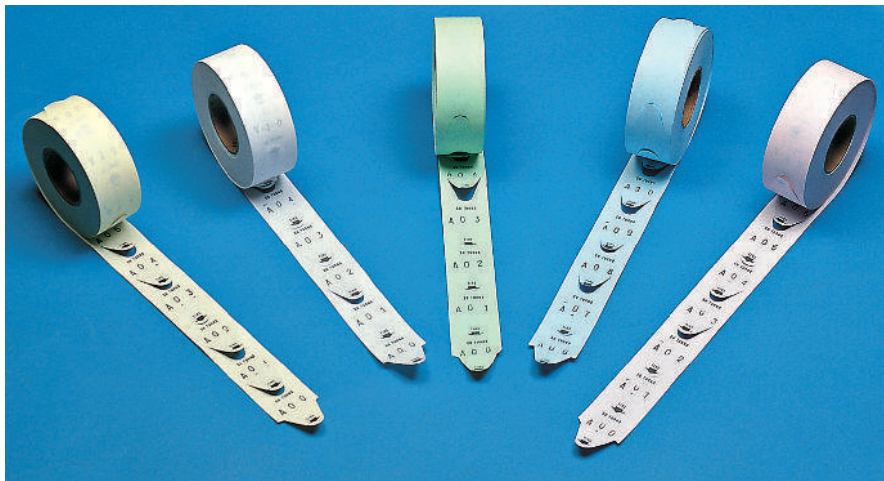

Rollos tickets dos dígitos (2000 números)

Two digits tickets rolls (2000 numbers)

Rouleaux de tickets deux chiffres (2000 numéros)

Ref.	Color Colour Couleur	Unidades Units Unités	Euros
RT-5-A	●	10	18,00
RT-5-AZ	●	10	18,00
RT-5-B	○	10	18,00
RT-5-R	●	10	18,00
RT-5-V	●	10	18,00

Rollos de tickets tres dígitos (2000 números)

Three digit ticket roll (2000 numbers)

Rouleaux de tickets (2000 numéros)

Ref.	Color Colour Couleur	Unidades Units Unités	Euros
RT-6-A	●	10	19,00
RT-6-AZ	●	10	19,00
RT-6-B	○	10	19,00
RT-6-R	●	10	19,00
RT-6-V	●	10	19,00

EXTERMINADORES DE INSECTOS DESCARGA ELÉCTRICA | ELECTRIC INSECT EXTERMINADOR | EXTERMINATEUR D'INSECTES DÉCHARGE ÉLECTRIQUE



Exterminador de insectos

Posición suspendido ó sobre su base, material de policarbonato.

Electric insect exterminator

Positioning hanging or standing on its base, material a polycarbonate.

Exterminateur d'insectes décharge électrique

Pose suspendu ou sur sa base, matériel polycarbonate.

Ref.	Medidas Size Dimensions	Voltaje Voltage Voltage	Tensión reja (V) Grid voltage (V) Tension grille (V)	Tubo luz actínica Actinic light tube Tube éclairage actinique	Superficie máxima (m ²) Tube maximum surface (m ²) Surface maximum (m ²)	Euros
Z-151	13 x 16 x 34,5 cm	220 V 50Hz	4000	1 x 11W	110	38,50



Exterminador de insectos por descarga eléctrica
Con mando a distancia, posición suspendido ó sobre su base, material ABS-Aluminio.

Electric insect killer
 With remote control, positioning can hang on wall or stand on its base, material ABS-Aluminium.

Exterminateur d'insectes décharge électrique
 Avec télécommande, pose suspendu ou sur sa base, matériel ABS-Alumin.

Ref.	Medidas Size Dimensions	Voltaje Voltage Voltage	Tensión reja (V) Grid voltage (V) Tension grille (V)	Tubo luz actínica Actinic light tube Tube éclairage actinique	Superficie máxima (m²) Tube maximum surface (m²) Surface maximum (m²)	Euros
Z-420-MD	39 x 30 x 10 cm	220-240 V	2000	2 x 10 W	300	75,00
Z-430-MD	49 x 34 x 10 cm	220-240 V 50 HZ	2000	2 x 15W	380	98,00
Z-440-MD	64 x 39 x 10 cm	220-240 V 50 HZ	2000	2 x 20W	451	125,00



Exterminador de insectos
Posición suspendido ó sobre su base, material acero-inox.

Insect exterminator
 Positioning can hang on wall or stand on its base, material stainless steel.

Exterminateur d'insectes
 Pose suspendu ou sur sa base, matériel acier-inox.

Ref.	Medidas Size Dimensions	Voltaje Voltage Voltage	Tensión reja (V) Grid voltage (V) Tension grille (V)	Tubo luz actínica Actinic light tube Tube éclairage actinique	Superficie máxima (m²) Tube maximum surface (m²) Surface maximum (m²)	Euros
Z-600	30 x 28 x 14 cm	220V 50/60Hz	2310V	2 x 11 W	300	98,00
Z-700	57 x 28 x 14 cm	220V 50/60Hz	5650	2 x 15W	380	119,00
Z-780	69 x 28 x 14 cm	220 V	4000	2 x 40W	600	145,00

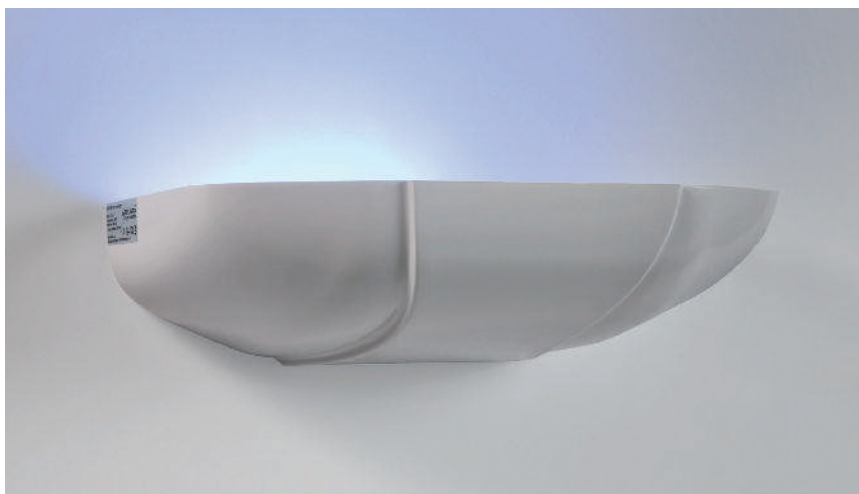

Trampa adhesiva
Para ref. Z-911. Paquete 6 unidades

Adhesive trap
For ref. Z-911. Pack 6 units

Piège adhésif
Pour réf. Z-911. 6 unités

Ref.	Unidades Units Unités	Euros
Z-911-A	6	20,00

Exterminador de insectos con trampa adhesiva
Lámpara 1x20 W bajo consumo, ABS blanco

Adhesive insect trap
Lamp 1x20 V, low energy, white ABS

Exterminateur d'insectes piège adhésif
Lampe 1x20 W, basse consommation, ABS blanc

Ref.	Color Colour Couleur	Medidas Size Dimensions	Voltaje Voltage Voltage	Lámpara luz actínica Actinic light lamp Lampe éclairage actinique	Euros
Z-911	○	49 x 19,7 x 10 cm	220 V	1 x 20 W	39,00
Z-911-N	●	49 x 19,7 x 10 cm	220 V	1 x 20 W	39,00

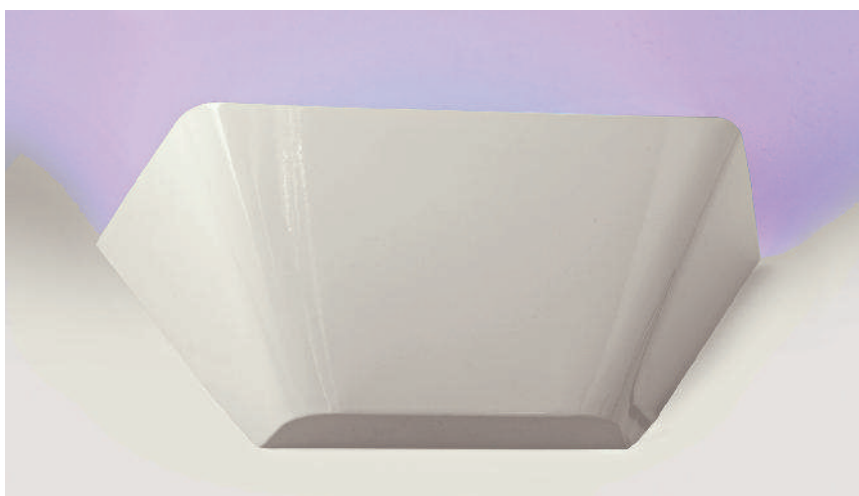

Lamina adhesiva
Para ref. Z-918. Paquete 6 unidades

Adhesive replacement
For Ref. Z-918, pack 6 units

Rechange adhésif
Pour réf. Z-918.

Ref.	Unidades Units Unités	Euros
Z-918-A	6	20,00

Exterminador de insectos con trampa adhesiva
Posición pared (aplique), material metálico Epoxi.

Recambio adhesiva : ref. Z-918-A

Adhesive insect trap
Positioning wall light, material metallic epoxy.

Adhesive replacement : ref. Z-918-A

Exterminateur d'insectes piège adhésif
Pose mur (applique), matériel métalloque époxy.

Rechange adhésif : réf. Z-918-A

Ref.	Color Colour Couleur	Medidas Size Dimensions	Voltaje Voltage Voltage	Lámpara luz actínica Actinic light lamp Lampe éclairage actinique	Euros
Z-918	○	45,5 x 18,7 x 15,5 cm	220 V	1 x 20W	79,00
Z-918-N	●	45,5 x 18,7 x 15,5 cm	220	1 x 20W	79,00

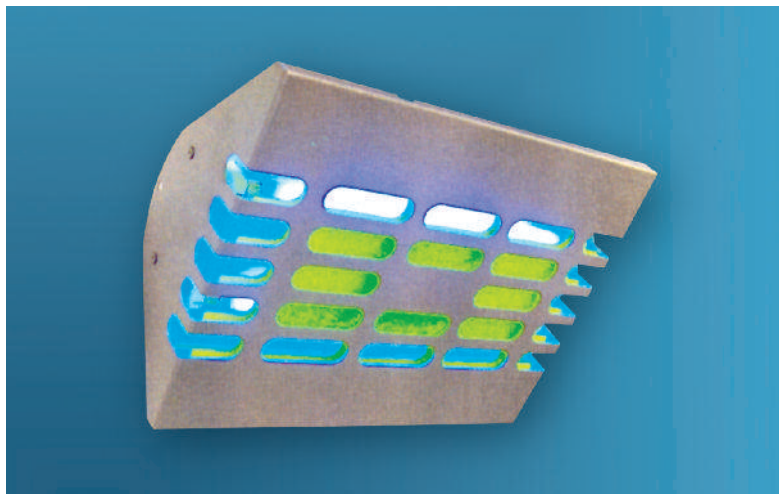

Exterminador de insectos con trampa adhesiva
Posición suspendido pared, material acero-inox.

Recambio adhesiva : ref. Z-950-A

Adhesive insect trap
 Positioning hung on wall, material stainless steel.

Adhesive replacement : ref. Z-950-A

Exterminateur d'insectes piège adhésif
Pose suspendu mur, matériel acier-inox.

Rechange adhésif : réf. Z-950-A

Ref.	Medidas Size Dimensions	Voltaje Voltage Voltage	Tubo luz actínica Actinic light tube Tube éclairage actinique	Euros
Z-950	47 x 35,5 x 18,5 cm	220	2 x 15W	175,00

Lamina adhesiva
Para ref. Z-950/Z-955. Paquete 6 unidades

Adhesive replacement
 For ref. Z-960. Pack 6 units

Réchange adhésif
Pour ref. Z-960-A. 6 unités.

Ref.	Unidades Units Unités	Euros
Z-950-A	6	30,00



Exterminador de insectos con trampa adhesiva.
Estanco IP65. Para ambientes con alto nivel de humedad. Posición suspendido, material acero-inox.

Recambio adhesivo: ref. Z-960-A

Adhesive insect trap.
 Waterproof. Suitable to work under high humidity ambient. Hung position. Stainless Steel made.

Adhesive replacement: ref. Z-960-A

Exterminateur d'insectes piège adhésif
Imperméable. Adéquat pour fonctionner dans ambient avec haut humidité. Position suspendu.
Fabriqué en acier inoxydable.

Réchange adhésif: réf. Z-960-A

Ref.	Medidas Size Dimensions	Voltaje Voltage Voltage	Tubo luz actínica Actinic light tube Tube éclairage actinique	Euros
Z-960	67 x 32,5 x 18,5 cm	220	2 x 20 W	198,00

Lamina adhesiva
Para ref. Z-960. Paquete 6 unidades

Adhesive replacement
 For ref. Z-960-A. Pack 6 units

Réchange adhésif
Pour ref. Z-960-A. 6 unités

Ref.	Unidades Units Unités	Euros
Z-960-A	6	32,00



Lamina adhesiva
Para ref. Z-930. Paquete 6 unidades

Adhesive replacement
 For ref. Z-940. Pack 6 units

Réchange adhésif
 Pour ref. Z-940. 6 unités.

Ref.	Unidades Units Unités	Euros
Z-930-A	6	24,00

Exterminador de insectos con trampa adhesiva dos caras.
Acabado acero inox / ABS



Posición suspendido o sobre su base

Recambio adhesivo: Z-930-A

Insect exterminator with two-sided adhesive trap.
 Stainless steel / ABS made

Position suspended or on its base

Adhesive refill: Z-930-A

Exterminateur d'insectes avec piège adhésif double face.
 Fabriqué en acier inoxydable / ABS

Position suspendue ou sur son socle

Recharge adhésive: Z-930-A

Ref.	Medidas Size Dimensions	Voltaje Voltage Voltage	Tubo luz actínica Actinic light tube Tube éclairage actinique	Euros
Z-930	57 x 28 x 14 cm	220	2 x 15W	125,00

DETECTOR CONTADOR BILLETES - MONEDAS | COUNTER DETECTOR BILL - COIN | COMPTEUR DÉTECTEUR BILLETS - MONNAIE



Detector de billetes electrónico arrastre automático, batería

Electronic note detector with automatic drag / détecteur, batterie

Détecteur de billets électronique avec déplacement automatique,
 batterie

Ref.	Voltaje (V) Voltage (V) Voltage (V)	Euros
A-530	220 V	173,00

Detector de billetes electrónico arrastre automático

Electronic note detector with automatic drag

Détecteur de billets électronique avec déplacement automatique

Ref.	Voltaje (V) Voltage (V) Voltage (V)	Euros
A-531	220 V	142,00



Contador separador monedas EURO

Coin serter EURO

Compteur séparateur de monnaie EURO

Ref.	Voltaje (V) Voltage (V) Voltage (V)	Euros
A-540	220 V	365,00



Detector contador billetes distinto valor EURO

Counteur detector different value bill EURO

Compteur detecteur billets de valeur différente EURO

Ref.	Voltaje (V) Voltage (V) Voltage (V)	Euros
A-550	220 V	865,00



Detector contador billetes igual valor EURO

Counteur detector equal value bill EURO

Compteur detecteur billets du même valeur EURO

Ref.	Voltaje (V) Voltage (V) Voltage (V)	Euros
A-555	220 V	355,00



0

7

**Hamburgueseras, Papel celofán, Embutidoras,
Jamoneras, Jamonero rotatorio 360°, Ganchos,
Libradores, Pinzas, Molde brochetas,
Enternecedor carne, Malla y anillas elásticas,
Protector hueso, Termómetros**

Hamburger presses, Cellophane foil, Sausage
filler, Jamoneras, Rotary Ham holder 360°,
Hooks, Scoops, Tongs, Brochette mold, Meat
tenderizer, Elastic mesh and rings, Bone
protector, Thermometer

*Hachoirs, Papiers cellophane, Emboutisseuses,
Jamoneras, Support de jambon rotatif 360°,
Crochets, Pelles à main, Pincas, Moule brochettes,
Attendrisseur, Maille et anneaux élastiques,
Protecteur d'os, Thermomètre*

135 - 148



Hamburguesera carcasa aluminio de 1 unidad ovalada 11x8

Aluminium hamburger press, 1 oval shaped unit 11x8

Hachoir carcasse aluminium pour 1 unité ovale 11x8

Ref.	Diámetro Diameter Diamètre	Euros
MH-1	OVAL 11 x 8 cm	54,00



Hamburguesera aluminio 1 unidad redonda 10 cm diámetro

Aluminium hamburger 1 unit rounded 10 cm diameter

Hachoir aluminium 1 unité ronde 10 cm diamètre

Ref.	Diámetro Diameter Diamètre	Euros
MH-1-R	Ø 10 cm	61,00



Hamburguesera carcasa aluminio de 2 unidades ovalada 11x8

Aluminium hamburger press, 2 oval shaped units 11x8

Hachoir carcasse aluminium pour 2 unités ovales 11x8

Ref.	Diámetro Diameter Diamètre	Euros
MH-2	OVAL 11 x 8 cm	198,00



Hamburguesera acero-inox de 2 unidades ovalada 11x8

Stainless steel hamburger press, 2 oval shaped units 11x8

Hachoir acier inox pour 2 unités ovale 11x8

Ref.	Diámetro Diameter Diamètre	Euros
MH-3	OVAL 11 X 8	255,00



Hamburguesera acero-inox de 4 unidades ovalada 11x8

Stainless steel hamburger 11x8

Hachoir acier inox pour 4 unités ovale 11x8

Ref.	Diámetro Diameter Diamètre	Euros
MH-4	OVAL 11 x 8 cm	310,00



Hamburguesera acero-inox 2 unidades redonda

Stainless steel hamburger press, 2 round units

Hachoir acier inox pour 2 unités rondes

Ref.	Diámetro Diameter Diamètre	Euros
MH-5	Ø 10 cm	265,00



Hamburguesera aluminio 2 unidades.

Aluminium hamburger press 2 units.

Hachoir aluminium 2 unités.

Ref.	Diámetro Diameter Diamètre	Euros
MH-8	Ø 10 cm	220,00



Máquina hamburgesas aluminio 2 unidades. Redonda 6,5 cm diámetro

Aluminum hamburger machine 2 round units 6,5 cm diameter

Machine à hamburger aluminium 2 unités ronde 6,5 cm diameter

Ref.	Diámetro Diameter Diamètre	Euros



Máquina hamburguesa semi-automática
Molde acero 1 unidad inox. Tipo papel celofán ref. PH-6. Contenedor para papel celofán incorporado. Funcionamiento: mediante brazo de mando que permite de modo sincronizado la compresión y extracción de la hamburguesa.

Semi-automatic hamburger press
 Round stainless steel mold for one unit.
 Cellophane foil type ref. PH-6. Features cellophane foil container. Working: move lever for synchronised compression and removal from the hamburger press.

Hachoir semi-automatique
 Moule en acier inox rond pour 1 unité. Type papier cellophane réf.: PH-6. Conteneur pour papier cellophane incorporé. Fonctionnement: au moyen d'un bras qui permet de façon synchronisée la compression et l'extraction du hamburger.

Ref.	Diámetro Diameter Diamètre	Euros
MH-10	Ø 10 cm	358,00



Maquina hamburguesa semi-automática
1 unidad en acero inox. Tipo papel celofán ref. PH-7. Características igual ref. MH-10

Semi-automatic hamburger press
 Single round stainless steel mold.
 Cellophane foil type PH- 7. Features sam as ref. MH-10

Hachoir semi-automatique
 1 moule en acier inox rond. Type papier cellophane réf PH-7. Même caractéristiques ref. MH-10

Ref.	Diámetro Diameter Diamètre	Euros
MH-13	Ø 13 cm	385,00



Maquina hamburguesa semi-automática
1 unidad en acero inox. redonda. Tipo papel celofán ref. PH-8. Características igual ref. MH-10

Semi-automatic hamburger press
 Single round stainless steel mold.
 Cellophane foil type PH- 8. Features sam as ref. MH-10

Hachoir semi-automatique
 1 moule en acier inox rond. Type papier cellophane réf PH-8. Même caractéristiques ref. MH-10

Ref.	Diámetro Diameter Diamètre	Euros
MH-15	Ø 15 cm	410,00



Hamburguesa 1 unidad

Hamburger press
 1 unit.

Hachoir
 1 unité.

Ref.	Diámetro Diameter Diamètre	Euros
MH-6	Ø 13 cm	255,00



Hamburguesa 2 unidades.

Hamburger press
 2 units.

Hachoir
 2 unités.

Ref.	Diámetro Diameter Diamètre	Euros
MH-7	Ø 13 cm	335,00

Molde 1 unidad redonda con expulsor hamburguesa

1 unit round mould

Moule 1 unité ronde

Ref.	Diámetro Diameter Diamètre	Euros
MH-25	Ø 5 cm	71,00
MH-20	Ø 6,5 cm	71,00
MH-21	Ø 10 cm	93,00
MH-22	Ø 13 cm	122,00
MH-23	Ø 15 cm	146,00



Paquete papel celofán redondo

Packet of round cellophane foil

Paquet papier cellophane rond

Ref.	Diámetro Diameter Diamètre	Unidades Units Unités	Euros
PH-3	Ø 5 cm	900	4,25
PH-4	Ø 6,5 cm	450	2,75
PH-6	Ø 10 cm	350	4,00
PH-5	OVAL 11 x 8 cm	450	3,30
PH-7	Ø 13 cm	350	7,65
PH-8	Ø 15 cm	350	9,75



Separador Interloncheados

Separator slices

Tranches de séparateur

Ref.	Medidas Size Dimensions	Unidades Units Unités	Euros
PS-60	160 x 60 mm	500	5,60
PS-70	160 x 70 mm	500	6,20
PS-80	160 x 80 mm	500	7,20



Embutidoras inox

Stainless steel sausage fillers

Emboutisseuses acier inoxydable

Ref.	Medidas Size Dimensions	Capacidad Capacity Capacité	Euros
ME-L5	55 x 19 x 21,5 cm	5 kg	340,00
ME-L8	65 x 19 x 21,5 cm	8 kg	365,00
ME-L8V	30 x 32 x 79 cm	8 kg	440,00

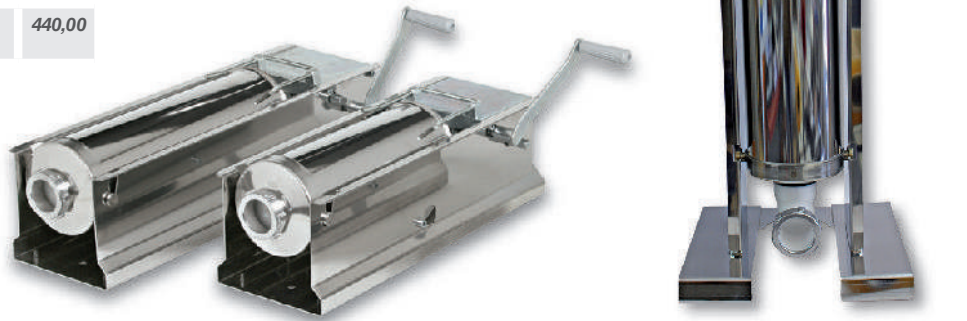

Embutidoras inox

Stainless steel sausage fillers

Emboutisseuses en acier inoxydable

Ref.	Medidas Size Dimensions	Peso Weight Poids	Capacidad Capacity Capacité	Euros
ME-L7	69 x 24 x 24 cm	27 kg	7 l	795,00
ME-L14	84 x 28 x 29 cm	35 kg	14 l	975,00



Despiece / Quartering / Dépeçage

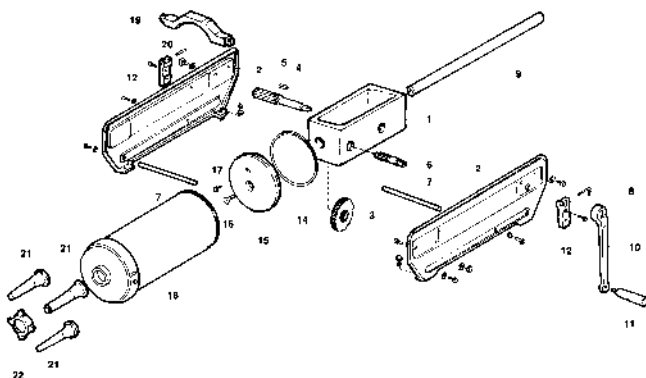

Medidas / Size / Dimensions

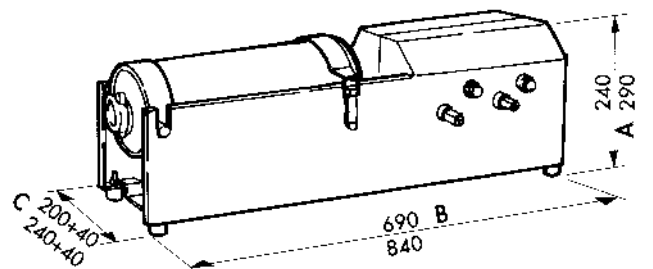

Juego 4 embudos inyección embutidora

Set of 4 injection filler funnels

Ensemble 4 entonnoirs injection emboutisseuses

Ref.	Euros
A-37	25,00



**Sujeta jamones
Rústico, base madera**

Ham holder
Rustic wooden base

*Présentoir jambons
Rustique base bois*

Ref.	Euros
SJ-4	69,00



**Sujeta jamón
Sobremesa o pared - base polietileno**

Ham holder
Free standing or fixed to wall - polyethylene base

*Serre-jambon
Sur table ou mur - base polyéthylène*

Ref.	Euros
SJ-5-M	99,50



**Sujeta jamones
Base y brazo polietileno blanco**

Ham holder
White polyethylene base

*Présentoir jambons
Base en polyéthylène blanche*

Ref.	Euros
SJ-6-B	49,00



**Sujeta jamones
Acero inox, soporte regulable**

Ham holder
Stainless steel fittable support

*Présentoir jambons
Inox. pied réglable*

Ref.	Euros
SJ-8	90,00



**Sujeta jamones
Fijo soporte madera**

Ham holder
Black removable arm, wooden base

*Présentoir jambons
Bras démontable bois, base bois*

Ref.	Euros
SJ-9	28,00



**Expositor jamones 20 unidades con
ruedas**

Wheel exhibitor ham 20 units

Présentoir jambons 20 unités avec roulettes

Ref.	Altura Height Hauteur	Euros
SJ-20	225 cm	196,00



Sujeta jamones Articulado giratorio inox base madera

Ham holder
Articulated rotating inox base wood

*Présentoir jambons
Base articulée tournante inox, base en bois*

Ref.	Euros
SJ-10	160,00



Sujeta jamones giratorio inox con base madera.

Subject based steel rotating wooden ams

Acier à base de bois objet rotatif jambons

Ref.	Euros
SJ-15	265,00



Sujeta jamones Articulado giratorio 360° inox base polietileno negro

Ham holder
Articulated rotating 360° inox base black polyethylene

*Présentoir jambons
Base articulée tournante 360° inox, base en polyéthylène noir*

Ref.	Euros
SJ-16	425,00



Sujeta jamones giratorio 360° inox base madera de encina

Subject based steel rotating 360° oak wooden ams

Acier à base de bois de chêne objet rotatif 360° pour jambons

Ref.	Euros
SJ-18	440,00

Mesa jamonera con soporte jamón inox giratorio

Ham table with stainless rotary ham holder

Table avec porte-jambon rotatif inox

Ref.	Medidas Size Dimensions	Euros
SJ-500	60 x 50 x 85 cm	475,00



Mesa jamonera con soporte jamón inox giratorio 360° Encimera madera de encina con dos estantes

Ham table with stainless rotary 360° ham holder
Oak wood countertop with two shelves

*Table jambon avec porte-jambon rotatif inox, 60 x 50 x 85 / 120
Comptoir en chêne avec deux tablettes*

Ref.	Medidas Size Dimensions	Euros
SJ-600	60 x 50 x 85 cm	740,00

Mesa jamonera con soporte jamón inox giratorio 360° Encimera madera de encina con dos estantes y dos ruedas giratorias con freno

Ham table with stainless rotary 360° ham holder
Oak wood countertop with two shelves and two rotating wheels with brake

*Table jambon avec porte-jambon rotatif inox, 60 x 50 x 85 / 120
Comptoir en chêne avec deux tablettes et deux roues tournantes avec frein*

Ref.	Medidas Size Dimensions	Euros
SJ-600-R	60 x 50 x 85 cm	775,00





Cono escurrejamonos

Ham drain cone
Cône égouttoir à jambon

Ref.	Unidades Units Unités	Euros
A-3	6	7,50



**Colgador jamones
12 unidades**

Ham hanger
12 units
Porte jambons
12 unités

Ref.	Euros
SJ-12	3,90



Cala jamón hueso de vaca

Ham piercer
Cale jambon

Ref.	Euros
A-27	15,50



Cala jamón mango madera

Ham piercer
Cale jambon

Ref.	Euros
A-28	14,50



Cala jamones bolígrafo

Ham piercer
Cale jambon

Ref.	Euros
A-29	15,00

GANCHOS ACERO-INOX | STAINLESS STEEL HOOKS | CROCHETS ACIER-INOX



Ganchos acero-inox

Stainless steel hooks
Crochets acier-inox

Ref.	Largo Long Longueur	Varilla Rod Tige	Unidades Units Unités	Euros
G-00	8 cm	4 mm	10	5,20
G-0	10 cm	4 mm	10	5,40
G-1	12 cm	5 mm	10	7,50
G-2	14 cm	5 mm	10	8,40
G-3	16 cm	5 mm	10	9,80
G-4	18 cm	5 mm	10	10,50

Ganchos acero-inox

Stainless steel hooks
Crochets acier-inox

Ref.	Largo Long Longueur	Varilla Rod Tige	Unidades Units Unités	Euros
G-5	20 cm	5 mm	10	13,20
G-6	22 cm	6 mm	10	15,00
G-7	20 cm	8 mm	10	30,00
G-8	30 cm	8 mm	10	42,00
G-9	18 cm	8 mm	10	28,00

Ganchos giratorio acero-inox

Stainless steel rotating hooks
Giratoire crochets acier-inox

Ref.	Largo Long Longueur	Varilla Rod Tige	Euros
G-10	25 cm	11 mm	18,00
G-11	30 cm	11 mm	19,00
G-12	25 cm	12 mm	12,00
G-13	30 cm	12 mm	14,00

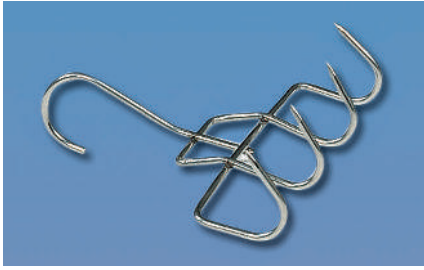

Gancho 4 puntas

4-spike hook

Crochet 4 pointes

Ref.	Euros
G-14	6,50



Gancho de pared

Wall hook

Crochet mural

Ref.	Medidas Size Dimensions	Euros
G-18	120 x 10	14,00
G-19	120 x 12	15,00



Gancho salchichero giratorio de 22 cms de altura con 4 brazos de 10 cms.

Revolving sausage hook of 22 cms height with 10 cms arms

Crochet à saucisses giratoire de 22 cms d'hauteur avec 4 bras de 10 cms

Ref.	Euros
G-15	29,00

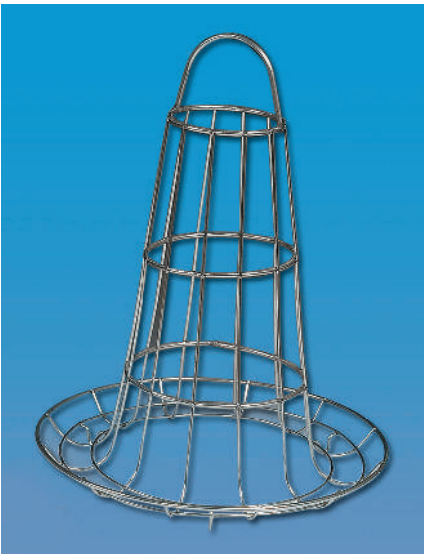

Torre pirámide salchichera

Pyramid sausage tower

Tour pyramide à saucisses

Ref.	Altura Height Hauteur	Diámetro Diameter Diamètre	Euros
G-20	39 cm	Ø 28 cm	48,00



Librador-cogedor, inox

Stainless steel scoops

Pellesà main, inox

Ref.	Medidas Size Dimensions	Euros
A-5-10	19 / 10 x 5 cm	12,50
A-5-12	21 / 12 x 6 cm	15,00
A-5-16	25 / 16 x 9 cm	16,50
A-5-20	29 / 18 x 10 cm	21,00
A-5-24	31 / 20 x 11 cm	25,50



Librador - cogedor inyectado

Plastic scoop

Pelle à main, plastique

Ref.	Medidas Size Dimensions	Euros
A-4-11	18 / 12 x 6 cm	2,40
A-4-14	24 / 16 x 8 cm	2,80
A-4-16	28 / 19 x 10 cm	3,30
A-4-20	33 / 22 x 11 cm	4,15
A-4-24	38 / 26 x 13 cm	5,10

PINZAS, PORTA ROLLS, SOPORTE TICKETS | TONGS, ROLL HOLDERS, TICKET HOLDER | PINCES, PORTE ROLEAUX, SUPPORT TICKET



Pinza acero inox con muelle

Stainless steel tong with spring

Pince acier inox avec ressort

Ref.	Euros
A-8	2,75



Pinza acero inox. para embutido

Stainless steel tong for cold meats

Pince acier inox pour charcuterie

Ref.	Euros
A-20	5,00



Pinza acero inox espina pescado

Stainless steel tong for fish bone

Pince acier inox arête poisson

Ref.	Euros
A-23	6,00



Pinza acero inox

Stainless steel tong

Pince acier inox

Ref.	Largo Long Longueur	Euros
A-24	24 cm	14,50

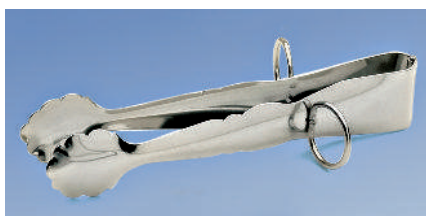

Pinza acero-inox con anillas

Stainless steel tong with rings

Pince acier inox avec anneaux

Ref.	Euros
A-26	9,50

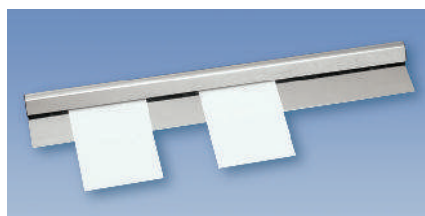

Porta-notas acer-inox, 60 cm con bolitas

Stainless steel note holder 60 cm, little balls system

Porte-notes acier inox 60 cm, système boules

Ref.	Euros
T-360	29,00

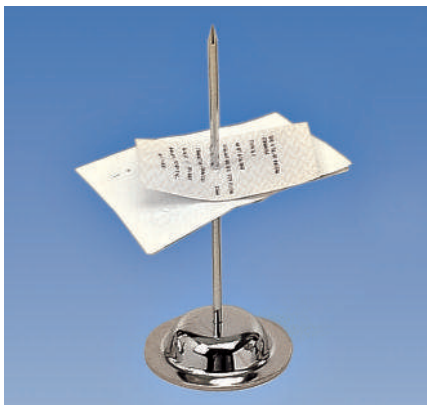

Soposte para pinchar tickets

Ticket holder

Support pour piquer les tickets

Ref.	Euros
PR-25	11,00



Porta rollo hilo

Thread roll holder

Porte rouleau fil

Ref.	Euros
PR-20	78,00

MÁQUINA MANUAL PINCHOS | MANUAL BROCHETTE MAKER | MACHINE MANUELLE POUR BROCHETTES

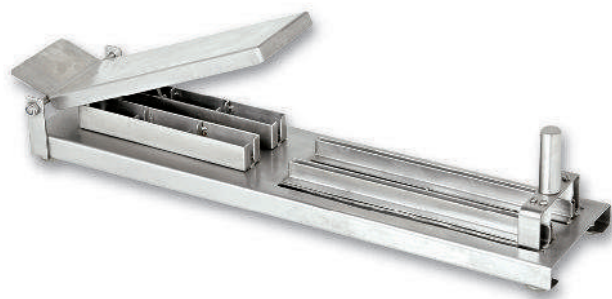

Máquina manual pinchos acero inox 2 unidades

Stainless steel maual brochette maker 2 units

Machine manuelle inox. pour brochettes 2 unités

Ref.	Euros
A-49	380,00

MOLDE BROCHETAS. PALILLOS | BROCHETTE MOLD. SKEEWERS | MOULE BROCHETTES. BROCHETTES

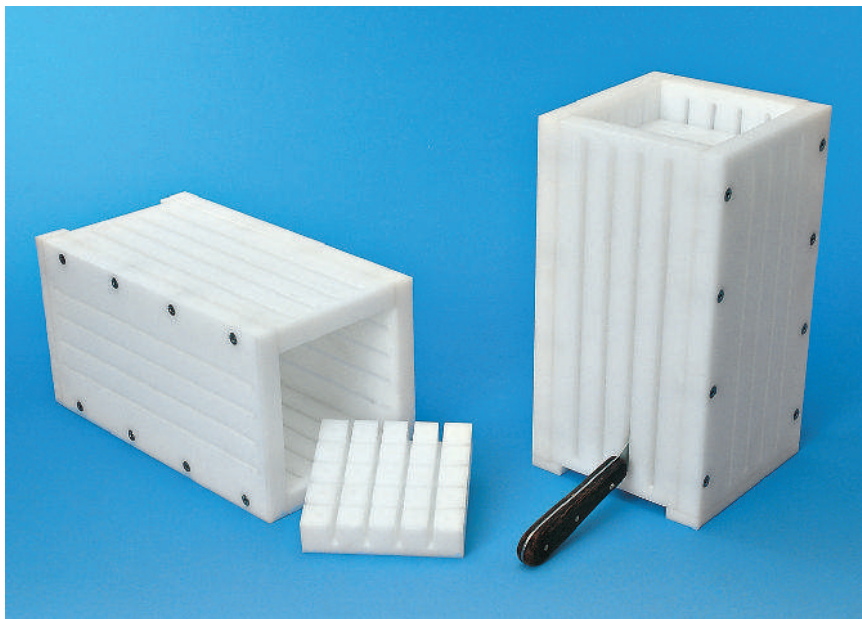

Molde brochetas polietileno para 25 unidades

Brochette polyethylene mold 25 units

Moule brochettes de polyéthylène

Ref.	Medidas Size Dimensions	Euros
A-50	16,5 x 16,5 x 31 cm	115,00



Palillos

Skewers

Brochette

Ref.	Largo Long Longueur	Unidades Units Unités	Euros
A-50-15	15 cm	200	1,35
A-50-25	25 cm	100	1,45
A-50-30	30 cm	100	1,85



Enternecedor carne minibla

Meat tenderizer

Attendrisseur manuel

Ref.	Euros
A-15	55,00

MALLA Y ANILLAS ELÁSTICAS | ELASTIC MESH AND RINGS | MAILLE ET ANNEAUX ÉLASTIQUES



Malla elástica

Elastic mesh

Maille élastique

Ref.	Tipo Type	Largo Long Longueur	Euros
H-12SR	12	50 m	8,50
H-14SR	14	50 m	9,85
H-16SR	16	50 m	10,00
H-18SR	18	50 m	10,50
H-20SR	20	50 m	12,00

Ref.	Tipo Type	Largo Long Longueur	Euros
H-22R	22	50 m	17,20
H-24R	24	50 m	17,70
H-26R	26	50 m	19,20
H-28R	28	50 m	20,80



Anillas elásticas

Elastic rings

Anneaux élastiques

Ref.	Tipo Type	Peso Weight Poids	Euros
H-120NV	120	3 kg	73,00
H-140NV	140	3 kg	73,00

TUBO PLÁSTICO | PLASTIC TUBE | TUBE EN PLASTIQUE



Tubo plastico naranja

Orange plastic tube

Orange tube en plastique

Ref.	Tipo Type	Euros
H-E10	10/86	36,50
H-E12	12/92	36,50
H-E14	14/110	36,50
H-E16	16/125	38,00
H-E18	18/140	38,00





Protector hueso

Bone protector

Protecteur d'os

Ref.	Tipo Type Type	Largo Long Longueur	Euros
H-P23	23	100 m	55,00
H-P33	33	100 m	81,00

Protector hueso pre-corte 7,5

Precut 7,5 bone protector

Protector 7,5 hueso pre-corte

Ref.	Tipo Type Type	Largo Long Longueur	Euros
H-P23-C	23	100 m	55,00
H-P33-C	33	100 m	81,00

TERMOMETROS | THERMOMETERS | THERMOMÈTRES |

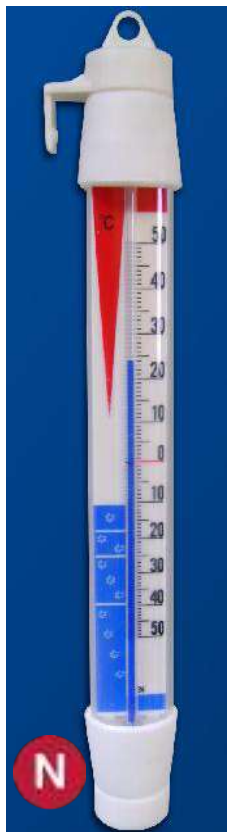

Termómetro para Frigorífico o Congelador vertical (-50+50°)

Vertical Thermometer for Refrigerator or Freezer (-50 + 50°)

Thermomètre vertical pour réfrigérateur ou congélateur (-50 + 50°)

Ref.	Euros
T-002	4,00

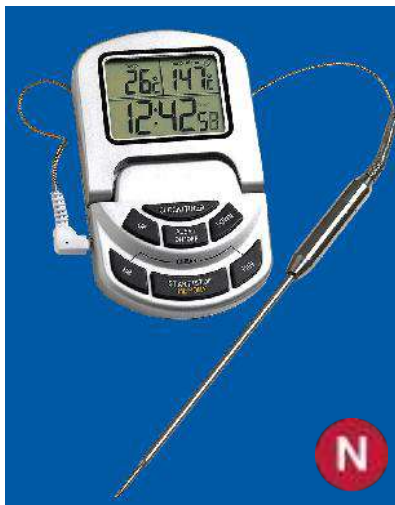

Termómetro Digital Horno con Sonda (0-300°)

Digital Thermometer Oven with Probe (0-300°)

Thermomètre numérique Four avec sonde (0-300°)

Ref.	Euros
T-003	50,00



Termometro Asado con Pincho (+55+88°)

Roast Thermometer with Pin (+55+88°)

Thermomètre Rôti avec Pique (+55+88°)

Ref.	Euros
T-005	17,50



Termometro Aceite con Gancho (0-300°)

Oil Thermometer with Hook (0-300°)

Thermomètre à huile avec crochet (0-300°)

Ref.	Euros
T-007	17,00



Termómetro Digital para Frigorífico o Congelador con Sonda (-50-70°)

Digital Thermometer for Refrigerator or Freezer with Probe (-50-70°)

Thermomètre numérique pour réfrigérateur ou congélateur avec sonde (-50-70°)

Ref.	Euros
T-009	25,00



Termómetro Laser de bolsillo (-50+300°)
 Pocket-Size Laser Thermometer (-50 + 300°)
 Thermomètre à laser de poche (-50 + 300°)

Ref.	Euros
T-012	70,00



Termómetro laser modelo Extra (-50+280°)
 Laser thermometer Extra model (-50 + 280°)
 Thermomètre laser modèle supplémentaire (-50 + 280°)

Ref.	Euros
T-008	92,00



Termómetro Frigorífico (-50 +50°)
 Refrigerator Thermometer (-50 + 50°)
 Thermomètre de réfrigérateur (-50 + 50°)

Ref.	Euros
T-050	14,00

Testador de Aceite (set de 2 tests)

Oil Tester (set of 2 tests)

Testeur d'huile (ensemble de 2 tests)

Ref.	Euros
TA-002	12,00



0

8

**Cierra bolsas - rollos, Etiquetadoras-rollos,
Naveteadoras, Caja cobro, Espejos vigilancia,
Carro servicio - Bandejero, Cestos - carros
autoservicio, Dispensadores bolsas, Carros
Gastronorm**

Bag-roll sealer, Labellers-rolls, Labelling gun,
Cash box, Vigilance mirror, Service trolley - tray,
Self-service basket - trolley, Bags dispensers,
Gastronorm trolley

*Machines ferme sacs, Étiquetteuses-rolls, Pistolet
à étiqueter, Caisses entregistreuses, Miroir de
surveillance, Chariot service - Plateau, Panier -
chariot self-service, Dispensateurs sacs, Chariot
Gastronorm*

149 - 160

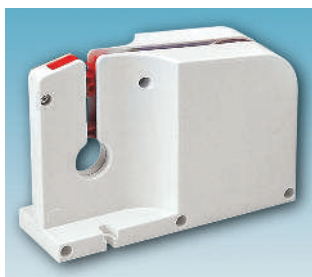

Máquina cierra bolsas plástico blanco

Bag sealer white plastic

Machine pour fermer les sacs plastique blanc

Ref.	Euros
CB-606	18,00



**Máquina cierra bolsas acero inox
Con cuchilla para cortar bolsa**

Bag sealer stainless steel
With bag cutter blade

*Machine pour fermer les sacs acier inox
Avec lame pour couper le sac*

Ref.	Euros
CB-101	25,00



Rollo de PVC 66 x 12

PVC Rolls 66 x 12

Rouleaux PVC 66 x 12

Ref.	Color Colour Couleur	Unidades Units Unités	Euros
RB-4-B	○	24	30,00
RB-4-A	●	24	30,00
RB-4-AZ	●	24	30,00
RB-4-R	●	24	30,00
RB-4-V	●	24	30,00
RB-4-T	⊕	24	28,00



Dispensador celo inyección para referencias RB-4

Cello tape dispenser injection for references RB-4

Distributeur scotch injection pour références RB-4

Ref.	Euros
CB-800	8,00

ETIQUETADORAS | LABELLERS | ÉTIQUETTEUSES



Etiquetadora una línea 8 dígitos

Labeller 1 line 8 digits

Étiquetteuse 1 ligne chiffres

Ref.	Euros
E-4	87,00



Etiquetadora una línea 6 dígitos

Labeller 1 line 6 digits

Étiquetteuse 1 ligne 6 chiffres

Ref.	Euros
E-5	73,00



Etiquetadora una línea 6 dígitos

Labeller 1 line 6 digits

Étiquetteuse 1 ligne 6 chiffres

Ref.	Euros
E-5-ECO	47,00



Etiquetadora dos líneas 8 dígitos

Labeller 2 line 8 digits

Étiquetteuse 2 lignes 8 chiffres

Ref.	Euros
E-6	135,00



Etiquetadora dos líneas 8 dígitos

Labeller 2 line 8 digits

Étiquetteuse 2 ligne 8 chiffres

Ref.	Euros
E-6-ECO	90,00

ROLLOS ETIQUETADORAS | LABELLERS | ÉTIQUETTEUSES



Rollos etiquetas

Label rolls

Rouleaux d'etiquettes

Ref.	Medidas Size Dimensions	Color Colour Couleur	Tipo Type Type	Unidades Units Unités	Euros
RE-5-B	26 x 12 mm	○	1	8	8,00
RE-5-N	26 x 12 mm	●	1	8	12,00
RE-6-B	26 x 16 mm	○	2	8	8,00
RE-6-N	26 x 16 cm	●	2	8	12,00

Rollo etiquetas dos líneas lote-caducidad

Label rolls 2 lines expiry date

Labell rolls 2 lines date de péremtion

Ref.	Medidas Size Dimensions	Unidades Units Unités	Euros
RE-7	26 x 16 mm	8	9,00

Rollos etiquetas dos líneas fecha envasado-fecha caducidad

Label rolls 2 lines packaging date and expiry date

Rouleaux d'etiquettes 2 lignes date d'envaser et péremtion

Ref.	Medidas Size Dimensions	Unidades Units Unités	Euros
RE-8	26 x 16 mm	8	9,00





Naveteadora Dennison homologada

Labelling gun Dennison approved

Pistolet à étiquetter Dennison homologué

Ref.	Euros
N-3	55,00

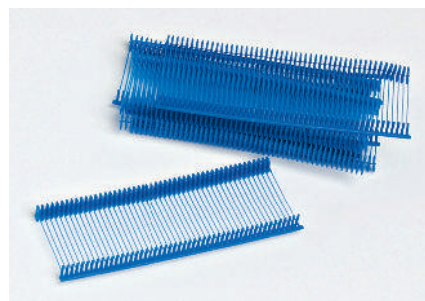

Navet cárnico standard 25 mm caja 10.000 unidades

Standard meat tag 25 mm

Étiquetteuse à viande standard 25 mm

Ref.	Unidades Units Unités	Euros
N-21	10000	25,00



Naveteadora Arrow standard

Labelling gun Arrow standard

Pistolet à étiquetter Arrow standard

Ref.	Euros
N-9	21,00

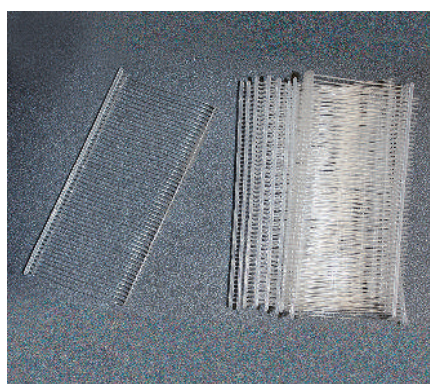

Naveteadora P.P. blanco caja 5.000 unidades

White P.P. tag 40 mm

Étiquetteuse P.P. blanc 40 mm

Ref.	Unidades Units Unités	Euros
N-22	5000	10,00

Navet cárnico homologado 25 mm caja 5000 unidades

Approved meat tag 25 mm

Étiquetteuse à viande homologuée 25 mm

Ref.	Unidades Units Unités	Euros
N-20	5000	45,00

Aguja Dennison standard 5 unidades

Standard meat pin Dennison 5 units

Aiguille à viande Dennison standard 5 unités

Ref.	Unidades Units Unités	Euros
N-30	5	14,00

Aguja Dennison homologada 5 unidades

Standard meat pin Dennison 5 units

Aiguille à viande Denisson standard 5 unités

Ref.	Unidades Units Unités	Euros
N-31	5	55,00

Aguja arrow standard 5 unidades

Standard meat pin arrow 5 units

Aiguille à viande arrow standard 5 unités

Ref.	Unidades Units Unités	Euros
N-32	5	14,00

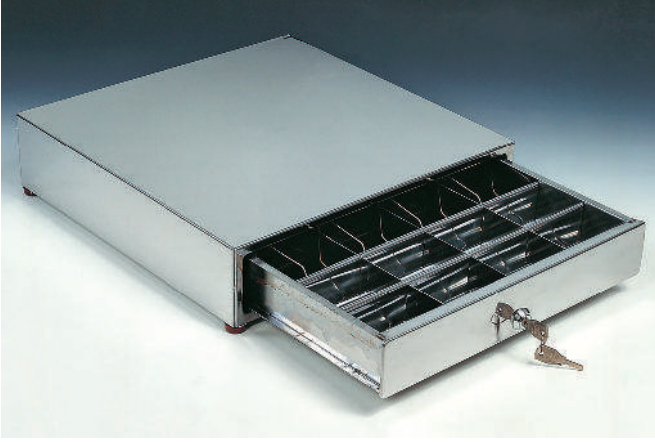

Caja monedero acero inox
Con 8 departamentos portamonedas y 4 portabilletes

Stainless steel cash box
 With 8 coin compartments and 4 for notes

Caisse enregistreuse acier inox
Avec 8 départements porte-monnaie et 4 porte-billets

Ref.	Medidas Size Dimensions	Euros
A-13	38 x 38 x 9 cm	195,00

ESPEJOS VIGILANCIA | VIGILANCE MIRROR | MIROIR DE SURVEILLANCE



Espejo de vigilancia para interiores
Con fijación a techo ó pared de orientación variable.

Indoor invigilation mirror
 Can be fitted to ceiling or wall, adjustable angle.

Miroir de surveillance pour espaces intérieurs
Avec fixation au plafond ou murale avec orientation variable.

Ref.	Diámetro Diameter Diamètre	Euros
A-19	Ø 60 cm	195,00

Espejo de vigilancia para exteriores
Con fijación a techo ó pared de orientación variable.

Outdoor invigilation mirror
 Can be fitted to ceiling or wall, adjustable angle.

Miroir de surveillance pour espaces extérieurs
Avec fixation au plafond ou murale avec orientation variable.

Ref.	Diámetro Diameter Diamètre	Euros
A-19-EX	Ø 60 cm	270,00



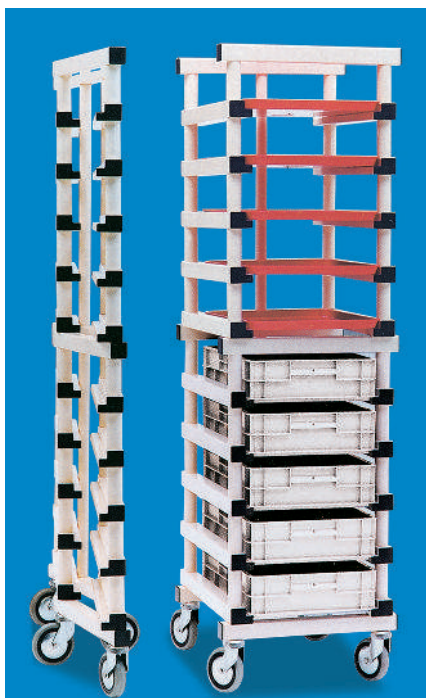

Carro bandejero plegable
Plegable: 10 guías. 2 ruedas giratorias. 2 ruedas giratorias con stop. Ruedas cincadas. Ideal para bandeja BI-15 ó cubeta CC-9/19/21

Foldable tray trolley
 Foldable: 10 rails. 2 swivel wheels. Wheels: zinc coated. Ideal for BI-15 tray or CC-9/19/21 deep tray

Chariot à plateaux-bacs plian
 Pliant: 10 guides. 2 roulettes giratoires. 2 roulettes giratoires avec stop. Roulettes: zinguées. Idéal pour plateau BI-15 ou cuvette CC-9/19/21

Ref.	Medidas Size Dimensions	Color Colour Couleur	Euros
R-10-G	54 x 65 x 179 cm	●	665,00
R-10-BE	54 x 65 x 179 cm	○	665,00

Carro bandejero plegable
Plegable: 10 guías. 2 ruedas giratorias. 2 ruedas giratorias con stop. Ruedas poliamida. Ideal para bandeja BI-15 ó cubeta CC-9/19/21

Foldable tray trolley
 Foldable: 10 rails. 2 swivel wheels. Wheels: polyamide. Ideal for BI-15 tray or CC-9/19/21 deep tray

Chariot à plateaux-bacs plian
 Pliant: 10 guides. 2 roulettes giratoires. 2 roulettes giratoires avec stop. Roulettes: polyamide. Idéal pour plateau BI-15 ou cuvette CC-9/19/21

Ref.	Medidas Size Dimensions	Color Colour Couleur	Euros
R-10-GP	54 x 65 x 179 cm	●	740,00
R-10-BEP	54 x 65 x 179 cm	○	740,00



Carro bandejero inox Tipo 60 x 40
20 guías. 2 ruedas giratorias. 2 ruedas giratorias con stop. Incluido ruedas. Embalaje desmontado. Ideal para bandeja BI-15

Stainless steel tray trolley Type 60 x 40
 20 rails. 2 swivel wheels. Wheels included. Packaged disassembled. Ideal for BI-15 tray

Chariot à plateaux-bacs inox Type 60 x 40
 20 guides. 2 roulettes giratoires. 2 roulettes giratoires avec stop. Compris roulettes. Emballage démonté. Idéal pour plateau BI-15

Ref.	Medidas Size Dimensions	Euros
R-20	46,5 x 63 x 186 cm	350,00

Carro bandejero inox 1/1
20 guías. 2 ruedas giratorias. 2 ruedas giratorias con stop. Incluido ruedas. Embalaje desmontado. Ideal para bandeja BI-15

Stainless steel tray trolley 1/1
 20 rails. 2 swivel wheels. Wheels included. Packaged disassembled. Ideal for BI-15 tray

Chariot à plateaux-bacs inox 1/1
 20 guides. 2 roulettes giratoires. 2 roulettes giratoires avec stop. Compris roulettes. Emballage démonté. Idéal pour plateau BI-15

Ref.	Medidas Size Dimensions	Euros
R-21	38 x 55 x 186 cm	342,00

Carro bandejero inox 2/1
20 guías. 2 ruedas giratorias. 2 ruedas giratorias con stop. Incluido ruedas. Embalaje desmontado.

Stainless steel tray trolley 2/1
 20 rails. 2 swivel wheels. Wheels included. Packaged disassembled.

Chariot à plateaux-bacs inox 2/1
 20 guides. 2 roulettes giratoires. 2 roulettes giratoires avec stop. Compris roulettes. Emballage démonté.

Ref.	Medidas Size Dimensions	Euros
R-22	58,5 x 67,5 x 186 cm	360,00

Bandejas ABS para carros R-10/R-20

ABS tray

Plateau ABS



Ref.	Medidas Size Dimensions	Color Colour Couleur	Euros
BI-15-B	58,5 x 41 x 2,5 cm	○	15,00
BI-15-R	58,5 x 41 x 2,5 cm	●	16,00
BI-15-N	58,5 x 41 x 2,5 cm	●	16,00



Bandejas Pasteleras Acero Inox. / Aluminio

Stainless steel / aluminum pastry trays

Ref.	Medidas Size Dimensions	Euros
BAC-1	60 x 40 x 1 cm	33,00
BAL-1	60 x 40 x 1 cm	27,00



**Carro de servicio, acero-inox
2 estanterías. Ruedas: 2 giratorias,
2 giratorias con stop. Embalaje:
desmontado**

Service trolley, stainless steel
2 Shelves. 2 revolving wheels, 2 revolving
wheels with brake. Package: disassembled

Chariot service, acier inox
2 Étagères. Roulettes 2 giratoires, 2
giratoires avec stop. Embalage: démonté

Ref.	Medidas Size Dimensions	Euros
R-30	80 x 50 x 93 cm	195,00



**Carro de servicio, acero-inox
3 estanterías. Ruedas: 2 giratorias,
2 giratorias con stop. Embalaje:
desmontado**

Service trolley, stainless steel
3 Shelves. 2 revolving wheels, 2 revolving
wheels with brake. Package: disassembled

Chariot service, acier inox
3 Étagères. Roulettes 2 giratoires, 2
giratoires avec stop. Embalage: démonté

Ref.	Medidas Size Dimensions	Euros
R-31	80 x 50 x 93 cm	228,00



Cesto un asa
Alta resistencia. Opciones: logotipos y/o otros colores : min. 720 unidades.

1-handle basket
High resistance. Options: logotypes and/or other colours: min 720 units

Panier 1 anses
Haute resistance. Optionnel: logotypes et/ou autres couleurs: min 720 unités

Ref.	Medidas Size Dimensions	Capacidad Capacity Capacité	Color Colour Couleur	Euros
R-2020-AZ	47 x 31 x 30 cm	28	●	14,00
R-2020-R	47 x 31 x 30 cm	28	●	14,00
R-2020-V	47 x 31 x 30 cm	28	●	14,00
R-2021	Carrito para apilar y mover R-2020			68,00
	Piling and transport kart R-2020			
	<i>Chariot pour empiler et déplacer R-2020</i>			



Cesto con 4 ruedas 2 fijas 2 giratorias
Asas abatibles

4-wheel basket with 2 fixed and 2 revolving wheels
Collapsible handles

Panier avec 4 roulettes 2 fixes 2 giratoires
Anses rabattables

Ref.	Medidas Size Dimensions	Color Colour Couleur	Capacidad Capacity Capacité	Euros
R-2032-AZ	50 x 34 x 36 cm	●	32 l	31,00
R-2032-R	50 x 34 x 36 cm	●	32 l	31,00
R-2032-V	50 x 34 x 36 cm	●	32 l	31,00



Cesto con 4 ruedas 2 fijas 2 giratorias
Asas abatibles

4-wheel basket with 2 fixed and 2 revolving wheels
Collapsible handles

Panier avec 4 roulettes 2 fixes
2 giratoires

Ref.	Medidas Size Dimensions	Color Colour Couleur	Capacidad Capacity Capacité	Euros
R-2054-AZ	55 x 39,5 x 44 cm	●	54 l	37,00
R-2054-R	55 x 39,5 x 44 cm	●	54 l	37,00
R-2054-V	55 x 39,5 x 44 cm	●	54 l	37,00



Carro autoservicio 110 l

110 l self-service trolley

Chariot self-service 110 l

Cadena inicio

Start chain

Chaîne démarrage

Ref.	Euros
R-CI110	38,50

Porta-monedas

Coin box

Porte monnaie

Ref.	Euros
R-PM110	30,00

Ref.	Medidas Size Dimensions	Capacidad Capacity Capacité	Euros
R-110	63,5 x 59 x 95,5 cm	110 l	222,00



Carro autoservicio 50 l

50 l self-service trolley

Chariot self-service 50 l

Ref.	Medidas Size Dimensions	Euros
R-50	57 x 47 x 91,5 cm	100,00



Carro autoservicio 75 l

75 l self-service trolley

Chariot self-service 75 l

Ref.	Medidas Size Dimensions	Euros
R-75	78 x 49,5 x 87,6 cm	140,00



Carro autoservicio 100 l

100 l self-service trolley

Chariot self-service 100 l

Ref.	Medidas Size Dimensions	Euros
R-100	85,5 x 51,5 x 101 cm	160,00



Cadena inicio

Start chain

Chaîne démarrage

Ref.	Euros
R-CI	34,00



Porta-monedas

Coin box

Porte monnaie

Ref.	Euros
R-PM	55,00



Dispensador porta guantes blanco

Glove dispenser for ref. W-12

Dispensateur port gants pour réf. W-12

Ref.	Color Colour Couleur	Euros
MR-104	○	80,00



Soporte para bolsas de bloque

Bag roll block holder

Support pour sacs en bloc

Ref.	Euros
MR-110	18,00

Soporte de fijación para réf. MR-103/104/117/119

Support stand for ref MR-103/104/117/119

Support de fixation pour réf. MR-103/104/117/119

Ref.	Color Colour Couleur	Euros
MR-105	○	78,00

Dispensador para bolsas en rollo de 500 unidades

Bag roll dispenser for MR-500 bags

Dispensateur pour sacs en rouleau réf. MR-500

Ref.	Color Colour Couleur	Euros
MR-103	○	92,00



Papelera blanca para réf MR-102/105

White epoxy paper bin for ref. MR-102/105

Support de fixation époxy blanc pour réf. MR-102/105

Ref.	Euros
MR-106	76,00

Soporte pared para ref. MR-117/119

White epoxy paper bin for ref. MR-102/105

Support mur époxy blanc pour réf. MR-117/119

Ref.	Color Colour Couleur	Euros
MR-116	○	32,00

Dispensador un brazo para rollo bolsas

One-arm white epoxy dispenser for ref. MR-500/505

Dispensateurs un bras époxy blanc pour réf. MR-500/505

Ref.	Color Colour Couleur	Euros
MR-117	○	38,00

Dispensador 2 brazos para rollo bolsas ref. MR-500/505

Two-arm white epoxy dispenser for ref. MR-500/505

Dispensateurs deux bras époxy blanc pour réf. MR-500/505

Ref.	Color Colour Couleur	Euros
MR-119	○	50,00



Dispensador porta guantes inox

Stainless steel glove dispenser for ref. W-12

Dispensateur porte-gants inox pour réf. W-12

Ref.	Euros
MR-104-I	51,00

Soporte de fijación inox. para réf. MR-103-I/104-I

Stainless steel support stand for ref MR-103-I/104-I

Support de fixation inox pour réf. MR-103-I/104-I

Ref.	Euros
MR-105-I	106,00

Papelera inox para ref. MR-105-I

Stainless steel paper bin for ref. MR-105-I

Poubelle inox pour réf. MR-105-I

Ref.	Euros
MR-106-I	95,00

Dispensador inox 2 brazos para rollo bolsos

Stainless steel dispenser 2 arms for bags roller

Dispensateur acier inox 2 bras pour rouleau sacs

Ref.	Euros
MR-119-I	48,00

Dispensador para bolsos en rollo de 500 unidades

Bag roll dispenser for MR-500 bags

Dispensateur pour sacs en rouleau réf. MR-500

Ref.	Euros
MR-103-I	77,00



Soporte para bolsos de bloque acero inox

Support for stainless steel block bags

Support pour sacs de bloc acier inox

Ref.	Euros
MR-115-I	34,00

ROLLOS BOLSAS | BAG ROLLS | ROULEAU SACS



**Rollo 500 bolsos 30x40
Para ref. MR-103 / MR-103-I / MR-117 / MR-119**

Bag roll 500 u. 30x40
For ref. MR-103, MR-103-I, MR-117, MR-119

*Rouleau 500 sacs 30x40
Pour réf. MR-103 / MR-103-I / MR-117 / MR-119*

Ref.	Unidades Units Unités	Euros
MR-500	500	6,75

**Rollo bolsos 1500 unidades (30x40)
Para ref. MR-117 / MR-119**

Bag roll 1500 units (30x40)
For ref. MR-117 / MR-119

*Rouleau sac 1500 un. (30x40)
Pour réf. MR-103 / 103I / 117 / 119*

Ref.	Unidades Units Unités	Euros
MR-505	1500	18,00

0

9

Cuchillería profesional, Afiladores, Chairas, Hachas, Tijeras, Espátulas, Bacaladera, Abre-Ostras, Sierras, Imanes, Guillotinas queso, Sacacorchos, Abrelatas, Guantes, Delantes, Material de un uso, Delantales protección, Guantes frío, Guantes malla acero-inox, Guantes y manoplas calor

Professional knives, Sharpeners, Axes, Scissors, Spatulas, Fish shears, Oyster sucker, Saws, Magnets, Cheese guillotines, Corkscrew, Can openers, Gloves, Aprons, Disposable material, Protective aprons, Cold gloves, Mesh steel-stainless gloves, Gloves and mittens heat

Couteaux professionnels, Aiguiseurs, Scies, Ciseaux, Spatules, Moorutiel manuel, Couteau à huitres, Scies, Aimants, Guillotines à fromage, Tire-Bouchon, Ouvre-Boîtes, Gants, Tabliers, Material d'un seul usage, Tabliers de protection, Gants froid, Gants en acier inoxydable, Gants et mitaines chaleur



Cuchillo carnicero alveolado
Mango inyectado

Indented butcher's knife
Plastic handle

Couteau de boucher alvéolé
Manche en plastique

Ref.	Largo Long Longueur	Color Colour Couleur	Euros
0151.310	310 mm	● ● ● ● ●	30,00
0151.355	355 mm	● ● ● ● ●	36,00
0151.395	395 mm	● ● ● ● ●	44,00



Cuchillo carnicero
Mango inyectado

Butcher's knife
Plastic handle

Couteau de boucher
Manche en plastique

Ref.	Largo Long Longueur	Color Colour Couleur	Euros
0170.155	155 mm	● ● ● ● ●	10,50
0170.185	185 mm	● ● ● ● ●	12,00
0170.210	210 mm	● ● ● ● ●	14,00
0170.260	260 mm	● ● ● ● ●	17,00
0170.310	310 mm	● ● ● ● ●	21,50
0170.355	355 mm	● ● ● ● ●	25,50
0170.395	395 mm	● ● ● ● ●	32,00



Cuchillo degollar
Mango inyectado

Sticking knife
Plastic handle

Couteau à égorger
Manche en plastique

Ref.	Largo Long Longueur	Color Colour Couleur	Euros
0370.165	165 mm	●	14,00
0370.195	195 mm	●	15,50
0370.225	225 mm	●	17,00



Cuchillo deshuesar
Mango inyectado

Boning knife
Plastic handle

Couteau à désosser
Manche en plastique

Ref.	Largo Long Longueur	Color Colour Couleur	Euros
0425.130	130 mm	● ● ● ● ●	9,50
0425.150	150 mm	● ● ● ● ●	10,50



Cuchillo deshuesar, hoja curva
Mango inyectado

Boning knife, cureve blade
Plastic handle

Couteau à désosser, lame courbe
Manche en plastique

Ref.	Largo Long Longueur	Color Colour Couleur	Euros
0430.150	150 cm	●●●●●	12,00



Cuchillo pescadero
Mango inyectado

Fish knife
Plastic handle

Couteau à poisson
Manche en plastique

Ref.	Largo Long Longueur	Color Colour Couleur	Euros
0701.320	320 mm	●●●●●	39,50
0701.350	350 mm	●●●●●	44,00
0701.370	370 mm	●●●●●	48,50



Cuchillo pescadero
L/vaca M/polietileno

Fish knife
Polyethylene handle

Couteau à poisson
Manche polyéthylène

Ref.	Largo Long Longueur	Color Colour Couleur	Euros
0720.350	350 mm	●	54,00
0720.380	380 mm	●	59,00



Cortante bacalao
Mango polietileno

Cod knife
Polyethylene handle

Couteau à morue
Manche polyéthylène

Ref.	Largo Long Longueur	Color Colour Couleur	Euros
0775.190	190 mm	●	43,00



Cuchillo jamonero
Mango polietileno. Hoja flexible

Ham knife
Polyethylene handle. Flexible blade

Couteau pour jambon
Manche polyéthylène. Lame flexible

Ref.	Largo Long Longueur	Color Colour Couleur	Euros
0500.305	305 mm	●	12,50



Cuchillo jamón
Mango inyectado

Ham knife
Plastic handle

Couteau pour jambon
Manche en plastique

Ref.	Largo Long Longueur	Color Colour Couleur	Euros
0526.250	250 mm	●	10,50
0526.300	300 mm	●	12,50



Cuchillo jamón
Hoja estrecha, mango polietileno

Ham knife
Narrow blade, polythylene handle

Couteau jambon
Lame étroite, manche polyéthylène

Ref.	Largo Long Longueur	Color Colour Couleur	Euros
0540.250	250 mm	●	12,00
0540.305	305 mm	●	13,00

Cuchillo jamonero
Mango polietileno. Hoja recia.

Ham knife
Polyethylene handle. Hard blade

Couteau pour jambon
Manche polyéthylène. Lame dure

Ref.	Largo Long Longueur	Color Colour Couleur	Euros
0521.250	250 mm	●	16,00

Cuchillo jamonero
Mango polietileno. Hoja recia.

Ham knife
Polyethylene handle. Hard blade

Couteau pour jambon
Manche polyéthylène. Lame dure

Ref.	Largo Long Longueur	Color Colour Couleur	Euros
0521.300	300 mm	●	17,50



Cuchillo cocinero forjado
Mango phenolkraff

Forged chef's knife
Phenolkraff handle

Couteau de cuisine forgé
Manche phenolkraff

Ref.	Largo Long Longueur	Color Colour Couleur	Euros
4000.100	100 mm	●●●●●	17,00
4000.150	150 mm	●●●●●	26,00
4000.200	200 mm	●●●●●	36,00
4000.250	250 mm	●●●●●	44,00
4000.300	300 mm	●●●●●	57,00

Cuchillo deshuesar
Mango phenoldraff

Boning knife
Phenoldraff handle

Couteau désosser
Manche phenolkraff

Ref.	Largo Long Longueur	Color Colour Couleur	Euros
4010.150	150 mm	●●●●●	24,00

Cuchillo jamonero
Mango phenolkraff

Ham knife
Phenolkraff handle

Couteau à désosser
Manche phenolkraff

Ref.	Largo Long Longueur	Color Colour Couleur	Euros
4020.300	300 mm	●●●●●	35,00

Trinchante cocinero
Mango phenolkraff

Carving knife
Phenolkraff handle

Couteau à découper
Manche phenolkraff

Ref.	Largo Long Longueur	Color Colour Couleur	Euros
4050.180	180 mm	●●●●●	29,50



Cuchillo Jamonero Mango Pom Alveolado

Ham indented knife handle pom

Couteau pour jambon alvéolé manche pom

Ref.	Largo Long Longueur	Color Colour Couleur	Euros
4120.250	250 mm	●	22,00
4120.300	300 mm	●	26,00



Cuchillo chef mango pom

Chef knife handle pom

Couteau de chef manche pom

Ref.	Largo Long Longueur	Color Colour Couleur	Euros
4100.250	250 mm	●	23,00



Cuchillo chef mango pom

Chef knife handle pom

Couteau de chef manche pom

Ref.	Largo Long Longueur	Color Colour Couleur	Euros
4100.200	200 mm	●	17,00



Cuchillo chef mango pom

Chef knife handle pom

Couteau de chef manche pom

Ref.	Largo Long Longueur	Color Colour Couleur	Euros
4100.150	150 mm	●	12,00



Cuchillo chef Santoku mango pom

Chef knife Santoku handle pom

Couteau de chef Santoku manche pom

Ref.	Largo Long Longueur	Color Colour Couleur	Euros
4105.180	180 mm	●	22,00



Cuchillo chef mango pom alveolado

Chef knife handle pom indented

Couteau de chef manche pom alvéolé

Ref.	Largo Long Longueur	Color Colour Couleur	Euros
4101.250	250 mm	●	28,00



Cuchillo chef para pan mango pom

Chef knife for bread handle pom

Couteau de chef pour pain manche pom

Ref.	Largo Long Longueur	Color Colour Couleur	Euros
4102.230	230 mm	●	15,00



Cuchillo Punta Aguda Mango Inyectado Anatomico y Antideslizante

Sharp Point Knife with Anatomical Injected Handle and Anti-Slip

Couteau à pointe fine avec manche injecté anatomique et antidérapant

Ref.	Largo Long Longueur	Color Colour Couleur	Euros
4200.150	150 mm	●●●●	11,00
4200.200	200 mm	●●●●	15,00
4200.250	250 mm	●●●●	20,00
4200.280	280 mm	●●●●	22,00



Cuchillo cocinero media luna

Half moon chef knife

Couteau de cuisine demi-lune

Ref.	Largo Long Longueur	Color Colour Couleur	Euros
4300.270	270 mm	●	38,00



Cuchillo de Golpe Mango Rallado Polipropileno

Hitting knife Polypropylene Grated Handle

Couteau à frapper Polypropylène Poignée Râpée

Ref.	Medidas Size Dimensions	Color Colour Couleur	Euros
0600.300	85 x 300 mm	●	40,00
0600.350	95 x 300 mm	●	52,00



Cuchillo cortante tallant
Mango inyectado

Cleaver knife
Plastic handle

Couperets
Manche en plastique

Ref.	Largo Long Longueur	Color Colour Couleur	Euros
0801.230	230 mm	● ● ● ● ●	35,50
0801.250	250 mm	● ● ● ● ●	44,00
0801.290	290 mm	● ● ● ● ●	55,00



Cuchillo cortante tallant
Cuchillo carnicero M/polietileno

Cleaver knife
Polyethylene handle

Couperets
Manche polyéthylène

Ref.	Largo Long Longueur	Peso Weight Poids	Color Colour Couleur	Euros
0820.240	240 mm	1000 gr	●	58,50
0820.260	260 mm	1200 gr	●	66,00



Cortante partir
Mango polietileno

Cleaver knife
Polyethylene handle

Couperet
Manche polyéthylène

Ref.	Largo Long Longueur	Color Colour Couleur	Euros
0840.320	320 mm	●	44,00



Cuchillo cortante tallant
Cuchillo carnicero M/inox

Cleaver knife
Stainless steel handle

Couperets
Manche inox

Ref.	Largo Long Longueur	Peso Weight Poids	Euros
0850.220	220 mm	1250 gr	97,00
0850.250	250 mm	1500 gr	116,00



**Cuchillo filetero
Mango inyectado**

Fillet knife
Plastic handle

*Couteau à fileter
Manche en plastique*

Ref.	Largo Long Longueur	Color Colour Couleur	Euros
0901.290	290 mm	● ● ● ● ●	37,00
0901.310	310 mm	● ● ● ● ●	42,00



**Cuchillo chuletero
Mango inyectado**

Chopping knife
Plastic handle

*Couteau à côtelettes
Manche en plastique*

Ref.	Largo Long Longueur	Color Colour Couleur	Euros
0905.290	290 mm	● ● ● ● ●	40,00
0905.310	310 mm	● ● ● ● ●	45,00

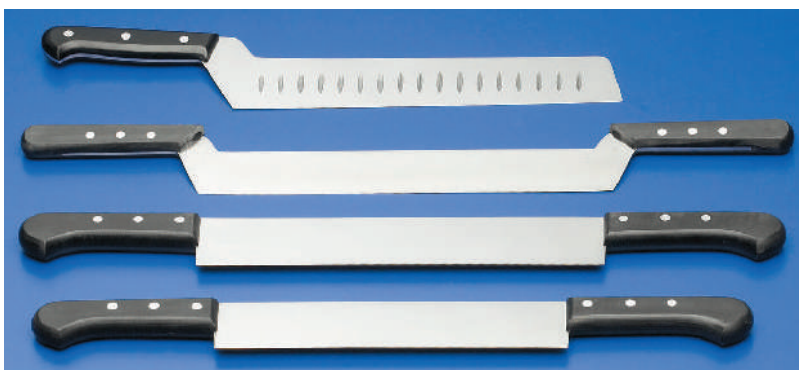

**Cuchillo queso
1 mango acodado con alveolos. Mango Phenolkruff**

Cheese knife
Phenolkruff handle

*Couteau à fromage
Manche Phenolkruff*

Ref.	Largo Long Longueur	Color Colour Couleur	Euros
1000.305	305 mm	●	42,00

**Cuchillo queso
2 mangos acodado. Mango polietileno**

Cheese knife
2 polyethylene handles

*Couteau à fromage
2 manches en polyéthylène*

Ref.	Largo Long Longueur	Color Colour Couleur	Euros
1001.320	320 mm	●	44,00

**Cuchillo queso
2 mangos polietileno**

Cheese knife
2 polyethylene handle

*Couteau à fromage
2 manches en poléthylène*

Ref.	Largo Long Longueur	Color Colour Couleur	Euros
1001.260	260 mm	●	25,00
1001.290	290 mm	●	31,00



Cuchillo queso curvado

Cheese curved knife

Fromage courbé couteau

Ref.	Largo Long Longueur	Color Colour Couleur	Euros
1000.450	45 cm	●	49,00



**Cuchillo queso
Sierra mango phenolkruff**

Cheese knife
Saw phenolkruff handle

*Couteau à fromage
Scie manche en phenolkruff*

Ref.	Largo Long Longueur	Color Colour Couleur	Euros
2002.250	250 mm	●	19,00
2002.310	310 mm	●	21,00



**Cuchillo charcutero salmón
Alveolado estrecho, mango polietileno**

Salmon charcuterie knife
Narrow indented, polythylene handle

*Couteau à Saumon
Alvólé étroite, manche polyéthylène*

Ref.	Largo Long Longueur	Color Colour Couleur	Euros
0560.250	250 mm	●	19,50
0560.310	310 mm	●	22,00



**Cuchillo charcutero-pastelero
Mango polietileno**

Carving-pastry knife
polyethylene handle

*Couteau de charcutier-pâtisser
Manche polyéthylène*

Ref.	Largo Long Longueur	Color Colour Couleur	Euros
0575.250	250 mm	●	20,00
0575.300	300 mm	●	26,00
0575.360	360 mm	●	33,00



**Aplasta filetes
Acero inox.**

Steak pounder
Stainless steel.

*Pelle pour aplatir les filets
Acier inox.*

Ref.	Peso Weight Poids	Euros
1705.150	1,5 kg	35,00



Gubia de bola m/polietileno blanco

Ball gouge m / polyethylene white ball

*Gouge à bille m / bille blanche en
polyéthylène*



Ref.	Largo Long Longueur	Color Colour Couleur	Euros
2401.260	260 mm	○	38,00



Aplasta filetes inox

Steak pounder

Pelle pour aplatir les filets

Ref.	Medidas Size Dimensions	Euros
1701.135	23 x 11 cm	29,00



Gubia recta

Gouge

Gouge

Ref.	Largo Long Longueur	Euros
2401.230	230 mm	27,50

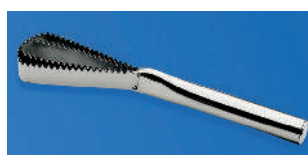

Escamador pescado profesional

Professional fish scaller

Écailleur à poisson professionnel

Ref.	Largo Long Longueur	Euros
2526.000	25 cm	14,50



**Cuchillo puntilla
Mango Penolkraff**

Pointed knife

Couteau pointu

Ref.	Largo Long Longueur	Euros
0010.100	100 mm	4,80



**Cuchillo serie clásica puntilla
curva mango pom**

Classic series knife curved sprig
handle pom

*Série Classic couteau courbe
branche manche pom*



Ref.	Largo Long Longueur	Color Colour Couleur	Euros
0015.065	65 mm	●	5,00



Afilador manual sobremesa

Table manual knife sharpener

Aigiseur manuel de table

Ref.	Euros
F-40	22,00

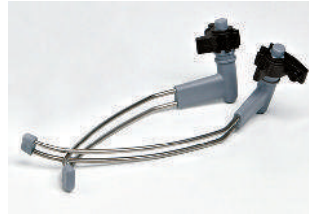

Juego varillas diamante para ref. F-35

Set of rods for ref. F-35

Lot de tiges pour réf. F-35

Ref.	Euros
F-36	40,00



Afilador manual diamante

Manual diamond knife sharpener

Aigiseur manuel diamant

Ref.	Euros
F-35	99,00

CHAIRAS PROFESIONAL | PROFESSIONAL SHARPENERS | FUSILS PROFESSIONNELS



Chairas profesional redonda

Professional sharpeners round

Fusils professionnels, rond

Ref.	Largo Long Longueur	Euros
3000.200	20 cm	7,50
3000.250	25 cm	16,00
3000.300	30 cm	17,00

Professional oval 30

Professional Oval

Professional Rond

Ref.	Largo Long Longueur	Euros
3050.300	30 cm	31,00



Professional redonda cruzeta inox 30 cm

Round 30 cm

Rond 30 cm

Ref.	Largo Long Longueur	Euros
3100.300	30 cm	36,00

Professional oval cruzeta inox

Oval

Ovale

Ref.	Largo Long Longueur	Euros
3150.300	30 cm	46,00



Professional redonda

Round

Rond

Ref.	Largo Long Longueur	Color Couleur Couleur	Euros
3200.300-N	30 cm	●	30,00
3200.300-AZ	30 cm	●	30,00
3200.300-A	30 cm	●	30,00
3200.300-R	30 cm	●	30,00
3200.300-V	30 cm	●	30,00



Oval profesional

Oval

Ovale

Ref.	Largo Long Longueur	Color Couleur Couleur	Euros
3250.300-N	30 cm	●	43,00
3250.300-AZ	30 cm	●	43,00
3250.300-A	30 cm	●	43,00
3250.300-R	30 cm	●	43,00
3250.300-V	30 cm	●	43,00



Professional oval acero inoxidable

Oval stainless steel

Ovale acier inox

Ref.	Largo Long Longueur	Color Couleur Couleur	Euros
3400.300	30 cm	●	89,00

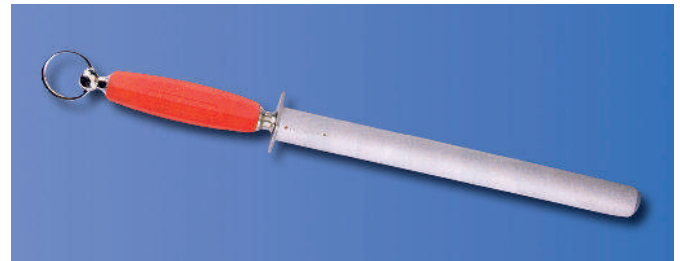

Lujo extra plana

Extra plane luxe

Luxe extra plat

Ref.	Largo Long Longueur	Color Couleur Couleur	Euros
3500.300	30 cm	●	86,00



Funda inyección para 4 cuchillos

Injection knife holder for 4 knives

Étui injection pour 4 couteaux

Ref.	Euros
F-10	37,00

Cinturón para funda inyección

Belt for réf. F-10

Ceinture pour réf. F-10

Ref.	Euros
F-11	14,00

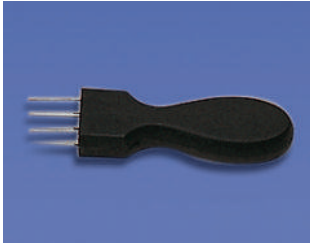

**Pincha salchichas 6 pinchos
Mango plástico, acero inox**

Sausage poker 6-spikes
Plastic handle, stainless steel

Pique saucisses 6 brochettes
Manche plastique, acier inox

Ref.	Euros
F-12	7,75



**Pincha salchichas redondo 16
pinchos inox**

Sausage poker 16-spikes
stainless steel. Plastic handle.

Pique saucisses 16 brochettes
inox. Manche plastique.

Ref.	Euros
F-17	6,00



Aguja de mechar

Stuffing needle

Aiguille à farcir

Ref.	Largo Long Longueur	Euros
F-13	30 cm	29,50



Aguja para hilo

Thread needle

Aiguille pour fil

Ref.	Largo Long Longueur	Euros
F-14	30 cm	22,50

PIEDRAS AFILAR - AFILADOR MANUAL | WHETSTONES - MANUAL SHARPENER | PIERRES À AIGUISER - AIGUISEUR MANUEL

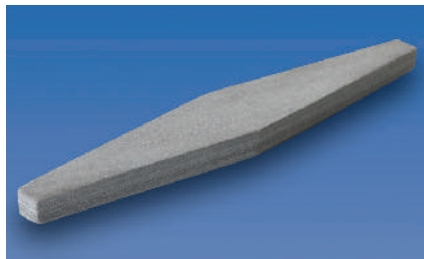

**Piedra de afilar natural. Grano negro.
Rombo**

Natural whetstone. Medium grain. Diamond shape

Pierre à aiguiser naturelle. Grain moyen. Losange.

Ref.	Largo Long Longueur	Euros
3900.700	23 cm	9,00

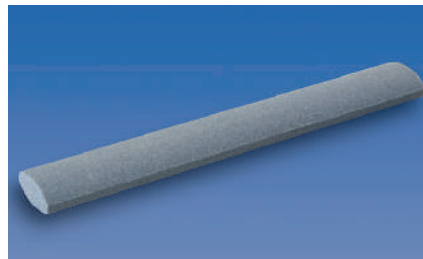

**Piedra de afilar corindón. Grano grueso.
Oval**

Natural whetstone. Rough grain. oval size

Pierre à aiguiser naturelle gros grain. Ovale

Ref.	Largo Long Longueur	Euros
3900.750	24 cm	8,00

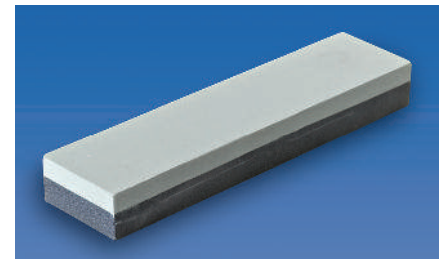

**Piedra de afilar silicar, 1 cara grano fino y
1 cara grano grueso**

Silicarb whetstone 1 side rough grain, 1 side fine grain

Pierre à aiguiser silicate, 1 face gros grain, 1 face grain fin

Ref.	Medidas Size Dimensions	Euros
3900.995	20 x 5 x 2 cm	30,00



Hacha de cámara
Mango polietileno

Axe

Scie

Ref.	Euros
A-6	116,00



Hacha de corte, 1kg
Mango polietileno

Axe, 1kg

Scie, 1kg

Ref.	Euros
A-16	100,00

TIJERAS MANUALES | MANUAL SCISSORS | CISEAUX MANUEL



Tijera pollero

Poultry scissors

Ciseaux volaille

Ref.	Largo Long Longueur	Euros
TP-210	21 cm	35,00
TP-230	23 cm	45,00
TP-250	25 cm	47,00



Tijera cocina-pescado
Con Tornillo

Kitchen-fish scissors

Ciseaux cuisine-poisson

Ref.	Largo Long Longueur	Euros
TC-180	18 cm	11,50
TC-200	20 cm	12,50
TC-220	22 cm	16,50
TC-240	24 cm	28,00
TC-280	28 cm	34,00



Tijera forjada

Forged scissors

Ciseaux forgés

Ref.	Largo Long Longueur	Euros
TF-200	20 cm	20,00
TF-225	22,5 cm	22,00



Tijera trinchar

Kitchen scissors

Ciseaux à découper

Ref.	Largo Long Longueur	Euros
TT-265	26,5 cm	16,00



Espátula plancha

Spatula

Spatule

Ref.	Largo Long Longueur	Euros
A-21	9 cm	12,00



Espátula pastelero

Spatula

Spatule

Ref.	Largo Long Longueur	Euros
A-51	20 cm	12,50



Espátula pastelero

Spatula

Spatule

Ref.	Largo Long Longueur	Euros
A-52	25 cm	17,00



Paleta charcutería

Spatula

Spatule

Ref.	Medidas Size Dimensions	Euros
A-14	12 x 6 cm	11,00



Paleta acodada

Spatula

Spatule

Ref.	Medidas Size Dimensions	Euros
A-22	15 x 8 cm	15,00



Paleta besugo ancha

Spatula

Spatule

Ref.	Medidas Size Dimensions	Euros
A-53	16 x 19 cm	23,50



Paleta besugo larga

Spatula

Spatule

Ref.	Medidas Size Dimensions	Euros
A-54	25 x 8 cm	22,00

BACALADERA - TIJERAS MOSTRADOR | MANUAL FISH SHEARS - COUNTER SCISSORS | MORUTIEL MANUEL - CISEAUX COMPTOIR



**Bacaladera manual
Base polietileno**

Manual fish shears
Polyethylene base

*Morutiel manuel
Base polyéthylène*

Ref.	Euros
A-25	117,00



**Tijera mostrador con soporte inox
Mango polietileno**

Counter scissors with stainless steel
Polyethylene handel

*Ciseaux comptoir avec support inox
Manche polyéthylène*

Ref.	Largo Long Longueur	Euros
TM-430	43 cm	171,00
TM-500	50 cm	197,00



Abre-ostras acero-inox con protector

Stainless steel oyster sucker

Couteau à huitres inox

Ref.	Euros
A-2	4,40



Rasqueta multiservicio

Multipurpose scarper

Raclette multiservice

Ref.	Medidas Size Dimensions	Euros
A-18	15 x 12 cm	11,00



Abre-ostras industrial

Industrial oyster sucker

Couteau à huitres industrial

Ref.	Euros
A-56	116,00

SIERRAS | SAWS | SCIES



**Sierra huesos
Inox, Mango negro**

Bones saw
Stainless steel, black handle

*Scie à os
Inox, anche noir*

Ref.	Largo Long Longueur	Euros
2460.400	40 cm	48,00
2460.450	45 cm	50,00
2460.500	50 cm	52,00

Hoja recambio sierra inox

Spare blade

Lame de rechange pour

Ref.	Largo Long Longueur	Euros
2476.420	40 cm	8,00
2476.450	45 cm	8,50
2476.500	50 cm	9,00

IMANES | MAGNETS | AIMANTS

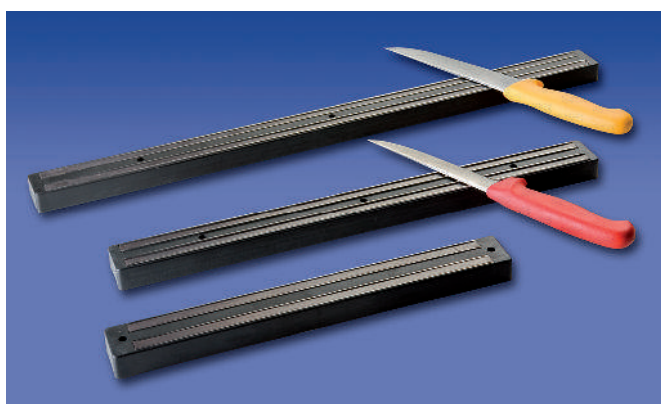

Imanes

Magnets

Aimants

Ref.	Largo Long Longueur	Euros
2500.330	33 cm	13,00
2500.450	45 cm	16,00
2500.600	60 cm	20,00



Guillotina queso blando
Base polietileno

Guillotine for slicing soft cheese
Polyethylene base

Guillotine pour découper le fromage à pâte
Base en polyéthylène

Ref.	Euros
F-20	132,00

Recambio guillotina ref. F-20
Pack 10 unidades

Spare lyre for ref. F-20
Pack 10 units

Fil pour réf. F-20
Pack 10 unités

Ref.	Unidades Units Unités	Euros
F-21	10	8,00

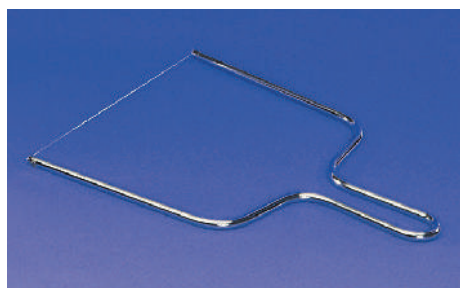

Lira queso blando de 21 cm

Lyre arch for slicing soft cheese

Arc lyre pour découper le fromage à pâte

Ref.	Euros
F-15	12,00

Recambio lira Ref. F-15
Pack 10 unidades

Spare lyre for ref. F-15
Pack 10 units

Fil pour réf. F-15
Pack 10 unités

Ref.	Unidades Units Unités	Euros
F-16	10	8,00



Rizador queso
Base madera 22 cm diametro

Cheese curling
Wood base 22 cm diameter

Fraiseur de fromage
Base de bois 22 cm diamètre

Ref.	Euros
F-22	25,00

ABRELATAS Y SACACORCHOS | CAN OPENERS - CORKSCREW | OUVRE-BOÎTES - TIRE-BOUCHON



Sacacorchos cromado pared

Chrome wall corkscrew

Tire-bouchon chromé mur

Ref.	Euros
A-65	181,00



Abrelatas industrial inox

Stainless steel industrial can opener

Ouvre-boîtes inox industriel

Ref.	Euros
A-70	130,00



Guantes 5 dedos inox banda nylon reversibles

Finger reversible stainless steel gloves nylon band

Gants 5 doigts inox bande nylon réversibles

Ref.	Color Colour Couleur	Tipo Type Type	Euros
A-1010	●	XS	94,00
A-1011	●	S	94,00
A-1012	○	M	94,00
A-1013	●	XM	94,00
A-1014	●	L	94,00
A-1015	●	XL	94,00



Sujeción de plástico para guantes inox

Plastic strap for stainless steel gloves

Fixation en plastique pour gants inox

Ref.	Unidades Units Unités	Euros
A-1001	100	35,00



Guantes 5 dedos inox banda plástico reversibles

5-finger reversibles stainless steel gloves plastic band

Gants 5 doigts inox bande plastique réversibles

Ref.	Color Colour Couleur	Tipo Type Type	Euros
A-1050	●	XS	98,00
A-1051	●	S	98,00
A-1052	○	M	98,00
A-1053	●	XM	98,00
A-1054	●	L	98,00
A-1055	●	XL	98,00

GUANTES ACERO-INOX CON MANGUITO | STAINLESS STEEL GLOVES WITH SLEEVE | GANTS ACIER INOX AVEC MANCHETTE

Guantes 5 dedos inox banda nylon con manguito policarbonato

5-finger stainless steel gloves with polycarbonate sleeve

Gants 5 doigts inox bande nylon avec manchette polycarbonate

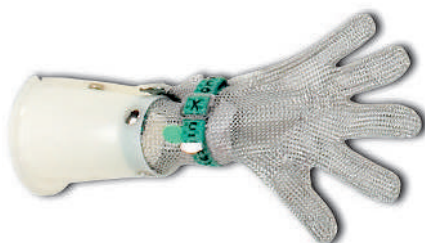

Ref.	Color Colour Couleur	Tipo Type Type	Euros
A-1020	●	XS	184,00
A-1021	●	S	184,00
A-1022	○	M	184,00
A-1023	●	XM	184,00
A-1024	●	L	184,00

Guantes 5 dedos inox banda nylon con manguito inox 16.5 cm reversible

5-finger stainless steel gloves nylon band with reversible 16.5 cm stainless steel sleeve

Gants 5 doigts inox bande nylon avec manchette inox 16.5 cm réversible



Ref.	Color Colour Couleur	Tipo Type Type	Euros
A-1110	●	XS	204,00
A-1111	●	S	204,00
A-1112	○	M	204,00
A-1113	●	XM	204,00
A-1114	●	L	204,00
A-1115	●	XL	204,00



Manguito plástico de 14 cm

Plastic sleeve 14 cm

Manchette plastique 14 cm

Ref.	Large Long Longueur	Euros
A-1000	14 cm	20,00



Guantes protección textil, 2 un. Talla pequeña. Banda de color blanco.

Textile cut-protection gloves. Size S. Band of white color.

Gants anti coupures textile. Taille S. Bande de couleur blanche.

Ref.	Tipo Type	Euros
A-2001	S	29,50



Guantes protección textil, 2 un. Talla mediana. Banda de color rojo.

Textile cut-protection gloves. Size M. Band of red color.

Gants anti coupures textile. Taille M. Bande de couleur rouge.

Ref.	Tipo Type	Euros
A-2002	M	29,50



Guantes protección textil, 2 un. Talla grande. Banda de color azul

Textile cut-protection gloves. Size L. Band of blue color

Gants anti coupures textile. Taille L. Bande de couleur bleue

Ref.	Tipo Type	Euros
A-2003	L	29,50



Guantes protección textil, 2 un. Talla muy grande. Banda de color naranja

Textile cut-protection gloves. Size XL. Orange band

Gants anti coupures textile. Taille XL. Bande orange

Ref.	Tipo Type	Euros
A-2004	XL	29,50

GUANTES-MANOPLAS PROTECCIÓN | CUT-PROTECTION GLOVES-MITTENS | GANTS-MITAINES ANTI COUPURES TEXTILE



Guantes anticolor con malla metálica 500°. Serraje vacuno amarillo, palma reforzada con malla metálica, forro aislante, longitud 33 cm.

Anti-heat gloves with metal mesh 500°. Yellow cow split leather, palm reinforced with metal mesh, insulating lining, length 33 cm.

Gants anti-chaleur avec maille métallique 500°. Cuir croûte de vache jaune, paume renforcée avec un treillis métallique, doublure isolante, longueur 33 cm.

Ref.	Unidades Units	Euros
A-8533	2	135,00



Manopla anticolor con malla metálica 500°. Serraje vacuno amarillo. Palma reforzada con malla metálica, forro aislante, longitud 40 cm

Anti-heat mitt with metal mesh 500°. Yellow cow split leather. Reinforced palm with metal mesh, insulating lining, length 40 cm

Gant anti-chaleur avec grille métallique 500°. Cuir croûte de vache jaune. Paume renforcée avec treillis métallique, doublure isolante, longueur 40 cm

Ref.	Unidades Units	Euros
A-8633	2	108,00



Guantes textil anticolor 350° Fibra meta-aramida de gran resistencia al calor y a la llama con forro algodón. Lavable. Ambidiestro

350° anti-heat textile gloves. Meta-aramid fiber of great resistance to heat and flame with cotton lining. Washable. Ambidextrous

Gants textiles anti-chaleur 350° Fibre méta-aramide de grande résistance à la chaleur et aux flammes avec doublure en coton. Lavable. Ambidextre

Ref.	Unidades Units	Euros
A-5548	2	29,00



Guantes textil anticolor 350°. Manguito 13 cm Fibra meta-aramida de gran resistencia al calor y a la llama con forro algodón. Lavable. Ambidiestro

350° anti-heat textile gloves. Sleeve 13 cm. Meta-aramid fiber of great resistance to heat and flame with cotton lining. Washable. Ambidextrous

Gants textiles anti-chaleur 350°. Manche 13 cm Fibre méta-aramide de grande résistance à la chaleur et aux flammes avec doublure en coton. Lavable Ambidextre

Ref.	Unidades Units	Euros
A-5548-13	2	34,00



A-760-10 - Guantes manipulación de alimentos congelados o refrigerados. Material poliéster con revestimiento de látex.

A-760-10 - Gloves handling frozen or refrigerated food. Polyester material with latex coating.

A-760-10 - Gants manipulant des aliments congelés ou réfrigérés. Matière polyester enduite de latex.

Ref.	Unidades Units Unités	Euros
A-760-8	2	9,00
A-760-9	2	9,00
A-760-10	2	9,00



Manopla silicona 300°

Silicon oven mitts 300°

Gant antichaleur silicone 300°

Ref.	Euros
A-3000	29,50



Manopla silicona 300° extra larga

Silicon oven mitts 300°

Gant antichaleur silicone 300° XL

Ref.	Euros
A-3005	44,00

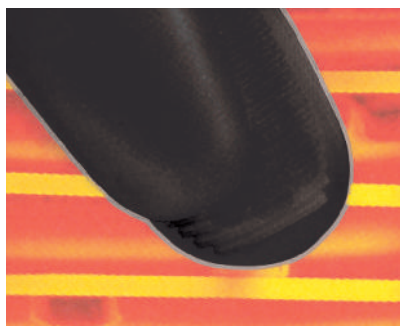

Delantal lamex plus

Lamex plus apron

Tablier lamex plus



Ref.	Medidas Size Dimensions	Euros
A-9-76	75 x 55 cm	163,00

Delantal malla acero
Medidas 75 x 55

Stainless steel mesh apron
Size 75 x 55

Tablier maille acier inox
Medidas 75 x 55

Ref.	Medidas Size Dimensions	Euros
A-9-76M	75 x 55 cm	185,00





Delantal PVC

PVC apron

Tablier PVC

Ref.	Medidas Size Dimensions	Color Colour Couleur	Euros
A-11-120-AZ	70 x 120	●	19,00
A-11-90	70 x 90	○	15,75
A-11-90-AZ	70 x 90	●	15,75
A-11-90-N	70 x 90	●	15,75
A-11-90-R	70 x 90	●	15,75



Delantal neopreno

PVC apron

Tablier PVC

Ref.	Medidas Size Dimensions	Color Colour Couleur	Euros
A-11-110	75 x 110	○	35,00



Delantal textil

Textile apron

Tablier textile

Ref.	Medidas Size Dimensions	Euros
A-17-B	75 x 90 cm	12,00
A-17-P	75 x 90 cm	12,00
A-17-BU	75 x 90 cm	12,00
A-17-F	75 x 90 cm	12,00
A-17-N	75 x 90 cm	12,00



Delantal textil rayado

Textil apron striped

Tablier textile rayé

Ref.	Medidas Size Dimensions	Euros
A-17-NV	75 x 90 cm	15,50
A-17-NBU	75 x 90 cm	15,50
A-17-BR	75 x 90 cm	15,50
A-17-BAZ	75 x 90 cm	15,50
A-17-BV	75 x 90 cm	15,50



**Guantes nitrilo
Paquete 100 uds.**

Nitrile gloves
100 units per box

Gants nitrile
Boîte 100 uts.

Ref.	Tipo Type Type	Euros
A-38-P	S	6,75
A-38-M	M	6,75
A-38-G	L	6,75



**Guantes plástico "un solo uso", paquete
100 und.**

Disposable plastic gloves, 100 uts box

Gants de plastique d'un seul usage, boîte
100 uts.

Ref.	Unidades Units Unités	Euros
A-12	100	0,85



**Guantes vinilo azul talla
Paquete 100 uds**

Vinyl gloves size
100 uts per box

Gants vinyle taille
Boîte 100 uts

Ref.	Tipo Type Type	Euros
A-39-P	S	5,40
A-39-M	M	5,40
A-39-G	L	5,40



Gorro circular blanco.
Paquete 100 uds

Round cap
100 uts box

Bonnet circulaire
Boîte 100 uts

Ref.	Euros
A-83	4,10

Bata blanca de polipropileno
Paquete 100 und

White polypropylene coat
10 uts box

Blouse blanche polypropylene
Boîte 10 uts

Ref.	Euros
A-82	12,00

Cubremanga polietileno
Paquete 100 und

Polyethylene sleeve cover
100 uts box

Polyéthylène couvre manches
Boîte 100 uts

Ref.	Euros
A-86	5,00

Cubrezapatos azul
Paquete 100 und

Shoes cover
100 uts box

Couvre chaussures
Boîte 100 uts

Ref.	Euros
A-84	3,10

Bata polietileno visitante
Paquete 10 und

Polyethylene visitor's coat
10 uts box

Blouse polyéthylène visiteur
Boîte 10 uts

Ref.	Euros
A-87	7,00

Kit visitante (gorro, bata, cubrezapatos, mascarilla)
Paquete 10 und

Visitor's kit (cap, coat, shoe covers, mask)
10 uts box

Ensemble visiteur (bonnet, blouse, couvre chaussures, masque)
Boîte 10 uts.

Ref.	Euros
A-88	8,50



Delantal polietileno 69 x 122
Paquete 100 und

Polyethylene apron 69 x 122
100 uts box

Tablier de polyéthylène 69 x 122
Boîte 100 uts

Ref.	Euros
A-85	7,50



Mascarilla polipropileno tres capas
Paquete 50 und

Mask in polypropylene three layers
50 uts box

Masque en polypropylène trois couches
Boîte 50 uts

Ref.	Euros
A-89	2,70



1

0

**Estanterias, Plataformas, Tarima antifatiga,
Palets, Losetas, Bancos de vestuario, Taquillas.**

Shelves, Platforms, Anti-fatigue mat, Pallets, Tiles,
Locker room bench, Lockers.

*Étagères, Plate-formes, Sol anti-fatigue, Palettes,
Carreaux, Banc vestiare, Casiers.*

183 - 196

HIGIÉNICAS

- Superficie lisa y no porosa.
- Fabricadas con resina de alta calidad.
- Evitan la condensación.
- No se oxidan.
- Cantos redondeados, para evitar accidentes.
- Colores: gris y beige.

RESISTENTES

- Resistencia a la carga 400 kg/m².
- Temperatura desde -40°C a 80°C.
- Inalterables a ácidos, aceites, grasa y humedades.
- No se manchan con el uso de detergentes.

VERSÁTILES

- Se amplían fácilmente con nuevos elementos.
- Se amoldan sin dificultad a diferentes alturas.
- Módulos especialmente diseñados para un máximo aprovechamiento de las esquinas.
- Pies regulables (opcionales), para suelos irregulares o inclinados.
- Ruedas (opcionales).

HYGIÉNIQUES

- Surface lisse et non poreuse.
- Fabriquées avec de la résine de grande qualité.
- Évitent la condensation.
- Ne se rouillent pas.
- Bords arrondis pour éviter les blessures.
- Couleurs: Gris et beige.

RÉSISTANTS

- Résistance à la charge 400 kg/m².
- Températures de -40°C à 80°C.
- Résistantes aux acides, huiles, graisses et à l'humidité.
- Ne se tachent pas avec l'utilisation de détergents.

VERSATILES

- Peuvent être facilement étendu avec de nouveaux éléments.
- Ils s'adaptent facilement à différentes hauteurs.
- Modules spécifiquement dessinées pour une utilisation optimale des coins.
- Pieds réglables (optionnels), pour terrains irréguliers ou inclinés.
- Roues (optionnelles).

MODULABLES

- Ils s'adaptent à toute organisation de l'espace.
- Ils sont construits sur mesure.

ADAPTABLES

- Modules dessinés pour convenir à tous les besoins.
- Ils se montent très facilement, sans avoir besoin d'outils grâce.
- Elles peuvent être déplacée aisément.

HYGIENIC

- Smooth non-porous surface.
- Manufactured with premium quality resin.
- They prevent condensation.
- Non rust.
- Rounded edges, to prevent accidents.
- Colours: Grey & beige.

HARDWEARING

- Withstand load of 400 kg/m².
- Temperatures from -40°C to 80°C.
- Unchanging to acids, oils, grease and moisture.
- Detergents doesn't stain it.

VERSATILE

- Easily extended with new elements.
- Adaptable to different heights.
- Modules specifically designed for optimal use of corners.
- Adjustable feet (optional), for uneven or sloping floor.
- Wheels (optional).

MODULAR

- They can fit at any pace allocation.
- They can be manufacture with any measure previous order.

ADAPTABLE

- Modules designed to suit any need.
- Very easy assembly without using metallic elements.
- Its lightness makes it very easy to move.

MODULARES

- Se acoplan a cualquier distribución de espacio.
- Sobre pedido se construyen en cualquier medida.

ADAPTABLES

- Módulos diseñados para adaptarse a cualquier necesidad.
- Se montan con mucha facilidad sin precisar elementos metálicos.
- Su ligereza permite desplazarlas fácilmente.



Estanterías de plástico 4 estantes cantos rectos

Plastic shelves 4 shelves straight edges

Etagères en plastique 4 étagères bords droits

Ref.	Medidas Size Dimensions	Color Colour Couleur	Euros
K-104	100 x 40 x 150 cm	OO●	390,00
K-105	100 x 50 x 150 cm	OO●	433,00
K-106	100 x 60 x 150 cm	OO●	480,00
K-124	120 x 40 x 150 cm	OO●	424,00
K-125	120 x 50 x 150 cm	OO●	472,00
K-126	120 x 60 x 150 cm	OO●	530,00
K-154	150 x 40 x 150 cm	OO●	528,00
K-155	150 x 50 x 150 cm	OO●	599,00
K-156	150 x 60 x 150 cm	OO●	663,00
K-204	200 x 40 x 150 cm	OO●	605,00
K-205	200 x 50 x 150 cm	OO●	682,00
K-206	200 x 60 x 150 cm	OO●	755,00



Rueda poliamida sin stop + refuerzo

Polyamide wheel without stop + reinforcement

Roue polyamide sans stop + reinforcement

Ref.	Euros
K-15-PS	78,00



Rueda cincada sin stop + refuerzo

Covered wheel without stop + reinforcement

Roue couverte sans stop + renfort

Ref.	Euros
K-15-S	58,00



Superficie lisa opcional polietileno 3 m/m
Optional 3 m/m polyethylene surface
Optionnel polyéthylène lisse 3 m/m



Desmontadas para transporte - Fácil manejo
Dismantled to be transported - Easy to use
Démonté pour le transport - Fonctionnement simple

Estantería de plástico 5 estantes cantos rectos

Plastic shelves 5 shelves

Étagères plastique 5 étages

Ref.	Medidas Size Dimensions	Color Colour Couleur	Euros
K-104-5	100 x 40 x 175 cm	OO●	488,00
K-105-5	100 x 50 x 175 cm	OO●	541,00
K-106-5	100 x 60 x 175 cm	OO●	601,00
K-124-5	120 x 40 x 175 cm	OO●	530,00
K-125-5	120 x 50 x 175 cm	OO●	590,00
K-126-5	120 x 60 x 175 cm	OO●	663,00
K-154-5	150 x 40 x 175 cm	OO●	660,00
K-155-5	150 x 50 x 175 cm	OO●	748,00
K-156-6	150 x 60 x 175 cm	OO●	828,00
K-204-5	200 x 40 x 150 cm	OO●	756,00
K-205-5	200 x 50 x 175 cm	OO●	852,00
K-206-5	200 x 60 x 175 cm	OO●	945,00



Pie regulable

Adjustable foot

Pied réglable

Ref.	Euros
K-10	4,15



Rueda cincada stop + refuerzo

Covered wheel

Roue couverte

Ref.	Euros
K-15	73,00



Rueda poliamida stop + refuerzo

Polyamide wheel

Roue polyamide

Ref.	Euros
K-15-P	91,00

ESTANTERÍAS RESISTENTES, HIGIÉNICAS, PLEGABLES Y VERSÁTILES

- Resistencia a la carga 250 kg/m².
- Temperatura desde -40°C a 80°C.
- Inalterable a la humedad, ácidos, aceites y grasas.
- No se mancha con el uso de detergentes.

HIGIÉNICAS

- Superficie no porosa.
- Fabricadas con resinas plásticas de alta calidad.
- Evitan la condensación.
- No se oxidan.
- Cantos romos para evitar accidentes.
- Baldas extraíbles para su lavado en lavavajillas.

VERSÁTILES

- Ampliables con nuevos elementos (modulares).
- Fácilmente amoldables a nuevas alturas.
- Módulos especialmente diseñados para un mejor aprovechamiento de las esquinas.
- Accesorios para diferentes utilidades.
- Plegables para el mejor aprovechamiento de espacios.
- Baldas rejadas o llenas.

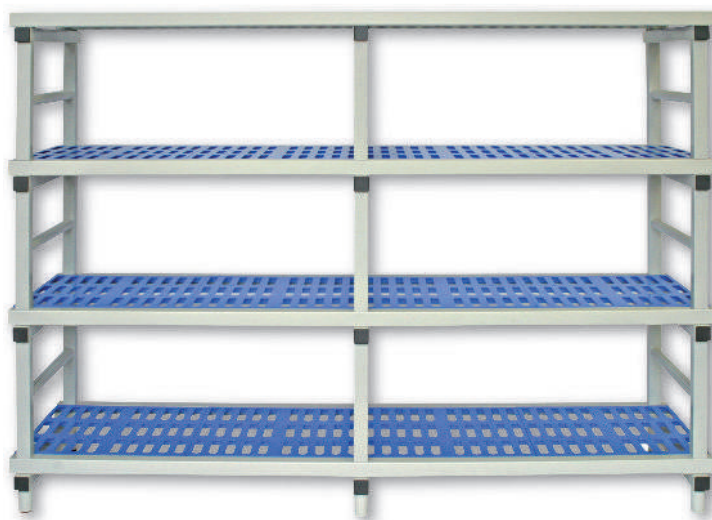

HARDWEARING , HYGIENIC, FOLDABLE AND VERSATILE SHELVES

- Withstand load of 250 kg/m².
- Temperatures from -40°C a 80°C.
- Not altered by humidity, acids, oils, grease.
- Are not stained by detergents.

HYGIENIC

- Non-porous surface.
- Made with high quality plastic resins.
- Avoid condensation.
- Will not rust.
- Blunt edges to avoid accidents.
- Shelves removable for washing in dishwasher.

VERSATILE

- Expandable with new elements (modular).
- Easily adaptable to new heights.
- Modules specifically designed for optimal use of corners.
- Accessories for different utilities.
- Foldables for better use of spaces.
- Shelves grilled or plain.



Baldas en tres formatos distintos que permiten montar estanterías de distintas profundidades / Three different formats shelves that allow assembling with different depth / Étagères dans trois formats différents qui permettent le montage de différentes profondeurs

ÉTAGÈRES RÉSISTANTES, HYGIÉNIQUES, PLIANTES ET VERSATILES

- Résistance à la charge 250 kg/m².
- Température de -40°C a 80°C.
- Inaltérables à l'humidité, aux acides, à l'huile et aux graisses.
- Ne se tachent pas avec l'utilisation de détergents.

HYGIÉNIQUE

- Surface non poreuse.
- Fabriquées avec de la résine de grande qualité.
- Évitent la condensation.
- Ne se rouillent pas.
- Bords arrondis pour éviter les accidents.
- Étagères amovibles pour le lavage en lave-vaisselle.

POLYVALENT

- Extensibles avec de nouveaux éléments (modulaires).
- Facilement adaptables à de nouvelles hauteurs.
- Modules spécialement dessinés pour une utilisation optimale des coins.
- Accessoires pour les différentes utilisations.
- Pliantes pour une meilleure utilisation de l'espace.
- Étagères en grillé ou lisses.

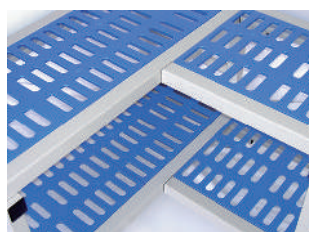

Encaje en "L" / "L" fitting / Lince "L"



Rueda / Wheel / Roues



Pata regulable / Adjustable foot / Pied réglable

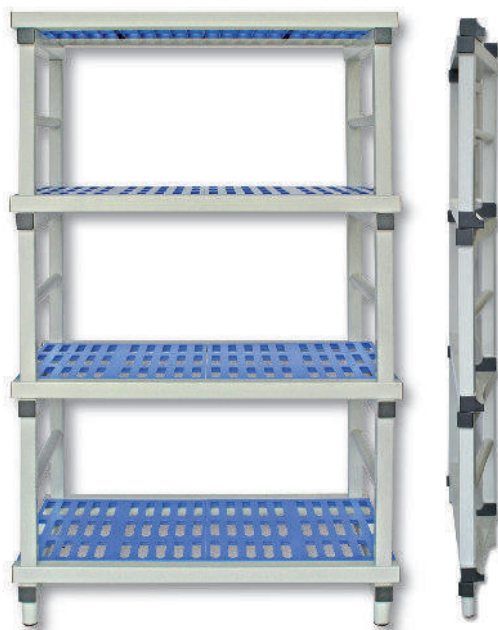

Sistema de encaje /
Fitting system /
Système de verrouillage



KML: Estante liso / Plain shelf /
Étagère lisse

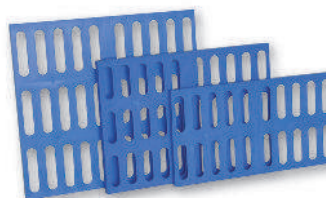

KM: Estante rejilla



El sistema de plegado permite optimizar el volumen de empaquetado y transporte /
Folding system makes improve packaging and transportation /
Le système de pliage permet d'optimiser le volume des emballages et des transports



Baldas extraíbles para facilitar su lavado, pueden lavarse en el lavavajillas /
Removable shelves to make them easy to wash, they can be cleaned in the dishwasher /
Étagères amovibles pour faciliter le ménage, peut être lavée dans le lave-vaisselle

Estantería de plástico plegable 5 estantes

Foldable plastic shelf 5 shelves

Étagère plastique pliante 5 étagères

Ref.	Medidas Size Dimensions	Color Colour Couleur	Euros
KM-104-5	100 x 40 x 175 cm	○○●	501,00
KM-105-5	100 x 50 x 175 cm	○○●	543,00
KM-106-5	100 x 60 x 175 cm	○○●	571,00
KM-124-S	120 x 40 x 175 cm	○○●	591,00
KM-125-5	120 x 50 x 175 cm	○○●	647,00
KM-126-5	120 x 60 x 175 cm	○○●	699,00
KM-154-5	150 x 40 x 175 cm	○○●	710,00
KM-155-5	150 x 50 x 175 cm	○○●	763,00
KM-156-5	150 x 60 x 175 cm	○○●	816,00
KM-204-5	200 x 40 x 175 cm	○○●	836,00
KM-205-5	200 x 50 x 175 cm	○○●	895,00
KM-206-5	200 x 60 x 175 cm	○○●	983,00

Estantería de plástico plegable 4 estantes

Foldable plastic shelf 4 shelves

Étagère plastique pliante 4 étagères

Ref.	Medidas Size Dimensions	Color Colour Couleur	Euros
KM-104	100 x 40 x 150 cm	○○●	401,00
KM-105	100 x 50 x 150 cm	○○●	434,00
KM-106	100 x 60 x 150 cm	○○●	457,00
KM-124	120 x 40 x 150 cm	○○●	473,00
KM-125	120 x 50 x 150 cm	○○●	518,00
KM-126	120 x 60 x 150 cm	○○●	559,00
KM-154	150 x 40 x 150 cm	○○●	568,00
KM-155	150 x 50 x 150 cm	○○●	611,00
KM-156	150 x 60 x 150 cm	○○●	653,00
KM-204	200 x 40 x 150 cm	○○●	669,00
KM-205	200 x 50 x 150 cm	○○●	716,00
KM-206	200 x 60 x 150 cm	○○●	786,00

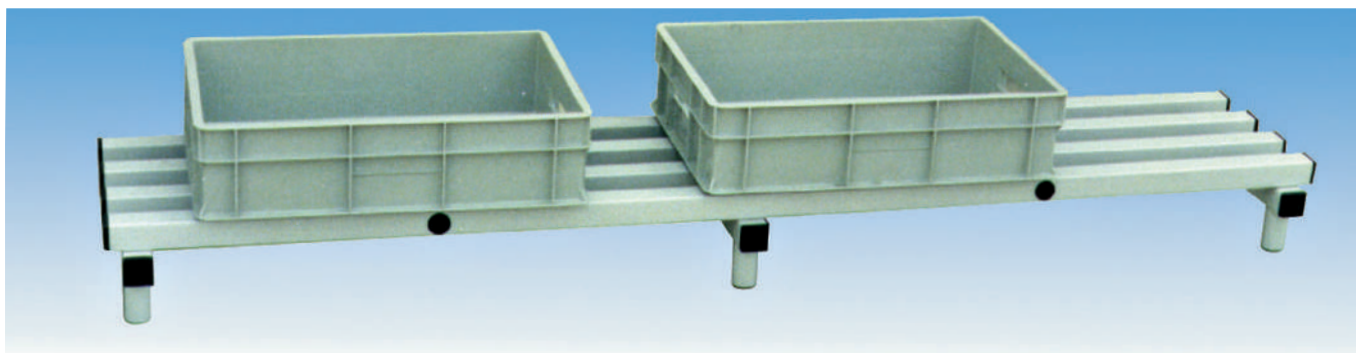

Plataforma para suelo camara

Platform for cold storage room floor

Plate-forme pour sol chamber

Ref.	Medidas Size Dimensions	Color Colour Couleur	Euros
KP-104	100 x 40 x 16,5 cm	○○●	90,00
KP-105	100 x 50 x 16,5 cm	○○●	100,00
KP-106	100 x 60 x 16,5 cm	○○●	113,00
KP-124	120 x 40 x 16,5 cm	○○●	102,00
KP-125	120 x 50 x 16,5 cm	○○●	117,00
KP-126	120 x 60 x 16,5 cm	○○●	129,00

Ref.	Medidas Size Dimensions	Color Colour Couleur	Euros
KP-154	150 x 40 x 16,5 cm	○○●	117,00
KP-155	150 x 50 x 16,5 cm	○○●	134,00
KP-156	150 x 60 x 16,5 cm	○○●	149,00
KP-204	200 x 40 x 16,5 cm	○○●	137,00
KP-205	200 x 50 x 16,5 cm	○○●	154,00
KP-206	200 x 60 x 16,5 cm	○○●	172,00

TARIMA ANTIFATIGA | ANTI-FATIGUE MAT | SOL ANTI-FATIGUE

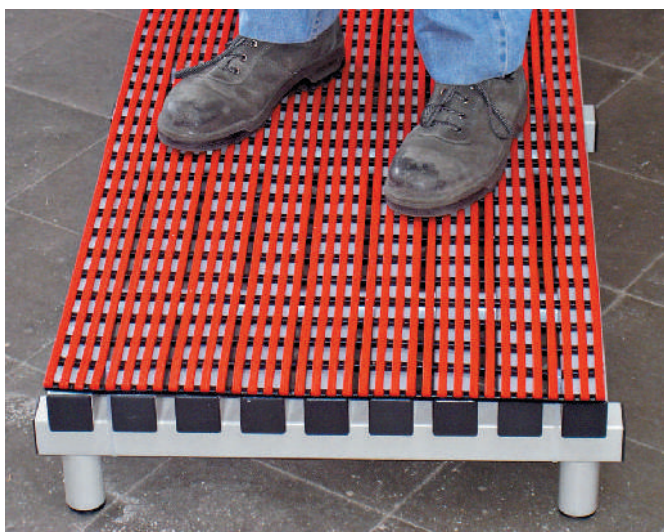

Tarima antifatiga

Ergonomia: Alfombra antifaga, mejoran el rendimiento del trabajador, son termoaislantes, protegen contra el frío.

Seguridad: Evitan deslizamientos en el puesto de trabajo y posibles descargas eléctricas, calidad antideslizante de clase R10/V10.

Medio ambiente: Fabricadas en material reciclado.

Color base gris, suelo azul.

Anti-fatigue mat
Ergonomics: Anti-fatigue carpeted mat, improve work performance, they are heat insulating, protected against the cold.

Safety: Prevent slipping over the work place and possible electric charges, class R10/V10 anti-slip quality.

Environment: Made of recycled material.

Grey base color, blue floor.

Sol anti-fatigue

Ergonomie: Tapis anti fatigue, améliore le rendement du travailleur, il est thermo isolant et protège du froid.

Sécurité: Il évite les glissades sur le poste de travail et d'éventuelles décharges électriques, qualité anti glissade de type R10/V10.

Environnement: Fait de matériaux recyclés.

Couleur de base gris, sol bleu.

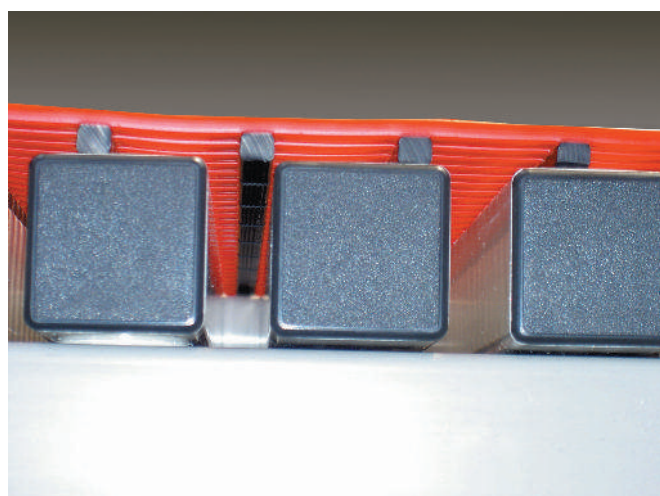

Ref.	Medidas Size Dimensions	Euros
KTA-105	100 x 50 x 18 cm	354,00
KTA-106	100 x 60 x 18 cm	424,00
KTA-107	100 x 70 x 18 cm	495,00
KTA-108	100 x 80 x 18 cm	566,00



Palet liso reciclado negro
Carga dinámica hasta 850 kg. Carga estática hasta 3.400 kg. Superficie apoyo 9 patas

Black smooth perforated pallet
Dynamic load up to 850 kg. Static load up to 3.400 kg. 9-leg support surface

Palette lisse recyclée noire
Charge dynamique jusqu'à 850 kg. Charge statique jusqu'à 3.400 kg. Surface soutien 9 pattes

Palet liso alimentario blanco
Carga dinámica hasta 850 kg. Carga estática hasta 3.400 kg. superficie apoyo 9 patas

Smooth white food-product pallet
Dynamic load up to 850 kg. Static load up to 3.400 kg. 9-leg support surface

Palette unie alimentaire blanche
Charge dynamique jusqu'à 850 kg. Charge static jusqu'à 3.400 kg. Surface soutien 9 pattes



Palet plástico reciclado negro
Carga dinámica hasta 1.000 kg. Carga estática hasta 4.000 kg

Plastic black recycled pallet
Dynamic load up to 1.000 kg. Static load up to 4.000 kg.

Palette plastique recyclé noire
Charge dynamique jusqu'à 1.000 kg. Charge statique jusqu'à 4.000 kg.

Ref.	Medidas Size Dimensions	Peso Weight Poids	Euros
KP-400	120 x 80 x 16 cm	21 kg	60,00



Palet plástico gris alimentario
Carga dinámica hasta 1.000 kg. Carga estática hasta 4.000 kg.

Plastic grey pallet food
Dynamic load up to 1.000 kg. Static load up to 4.000 kg

Palette plastique gris nourriture
Charge dynamique jusqu'à 1.000 kg. Charge statique jusqu'à 4.000 kg.

Ref.	Medidas Size Dimensions	Peso Weight Poids	Euros
KP-500	120 x 80 x 16 cm	18	85,00



Palet perforado reciclado negro
Carga dinámica hasta 850 kg. Carga estática hasta 3.400 kg. Superficie apoyo 9 patas

Black recycled perforated pallet
Dynamic load up to 850 kg. Static load up to 3.400 kg. 9-leg support surface

Palette perforée recyclée noire
Charge dynamique jusqu'à 850 kg. Charge statique jusqu'à 3.400 kg. Surface soutien 9 pattes

Ref.	Medidas Size Dimensions	Peso Weight Poids	Euros
KP-250	120 x 80 x 14,5 cm	6,5 kg	30,00





Loseta suelo

Floor tile

Carreaux sol

Ref.	Medidas Size Dimensions	Color Colour Couleur	Euros
KL-25	50 x 50 x 2,5 cm	●○●	12,50

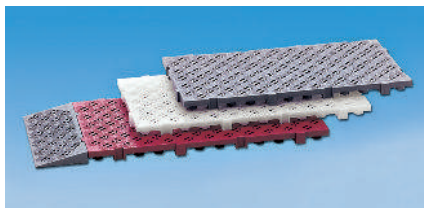

Loseta suelo

Floor tile

Carreaux sol

Ref.	Medidas Size Dimensions	Color Colour Couleur	Euros
KL-100	100 x 50 x 5 cm	●○●	40,00



Rampa para ref. KL-100 y KL-55

Floor rampe for ref. KL-100 and KL-55

Rampe sol for réf. KL-100 et KL-55

Ref.	Medidas Size Dimensions	Color Colour Couleur	Euros
KL-50	50 x 20 cm	●○●	18,00

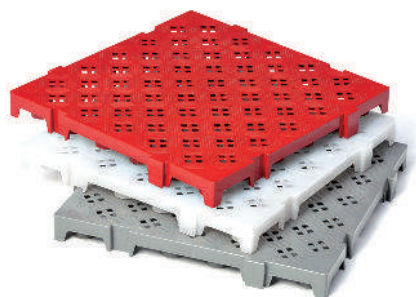

Loseta suelo

Floor tile

Carreaux sol

Ref.	Medidas Size Dimensions	Color Colour Couleur	Euros
KL-55	50 x 50 x 5 cm	●○●	19,00

BANCOS DE VESTUARIO CANTOS RECTOS | LOCKER ROOM BENCH | BANC VESTIAIRE



kbv - Banco vestuario

kbv - Locker room bench

kbv - Banc vestiaire

Ref.	Medidas Size Dimensions	Color Colour Couleur	Euros
KBV-100	100 x 35 x 48,5 cm	○○●	211,00
KBV-150	150 x 35 x 48,5 cm	○○●	274,00
KBV-200	200 x 35 x 48,5 cm	○○●	322,00

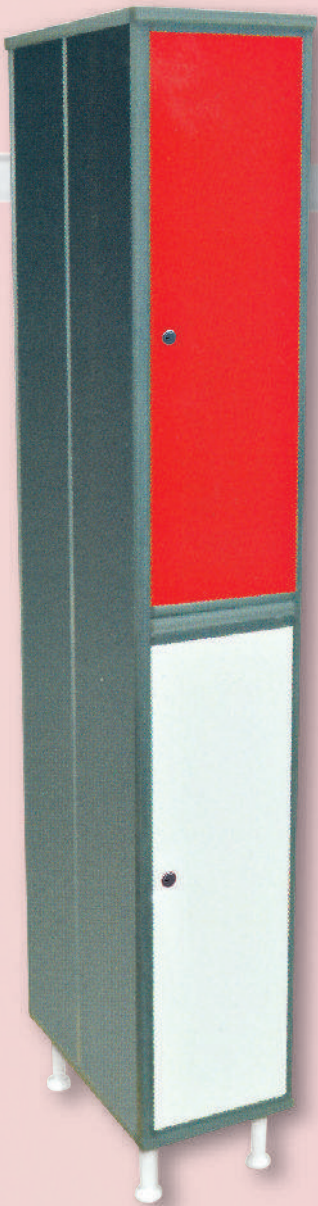

**SON VERSÁTILES RESISTENTES
Y MUY COMPETITIVAS /**
VERSATILES, RESISTANTS
AND VERY COMPETITIVES /
VERSATILES, RESISTANTS
AND TRÈS COMPETITIVES



Personalización /
Customization /
Personnalisation



Patas regulables /
Adjustable foot /
Pied réglable

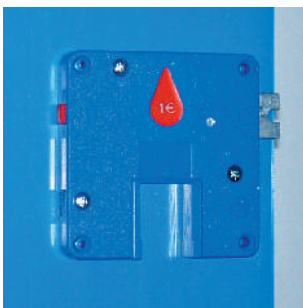
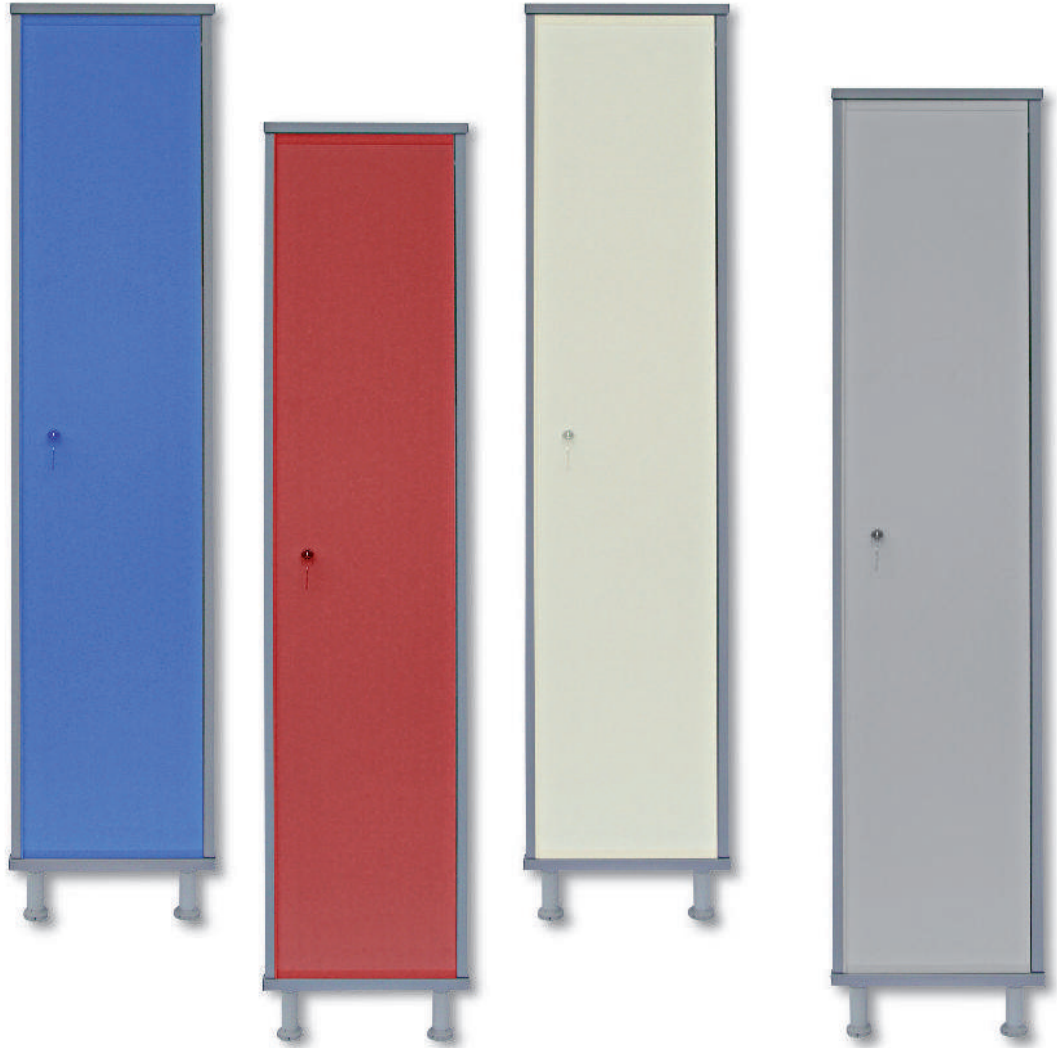

Cerradura de moneda /
Coin lock /
Pièce de verrouillage

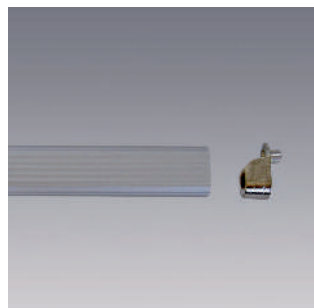

1/2 estante y barra de colgar /
Shelve and holding rail /
Étagère et garde-robe



Cerradura estándar /
Standard lock /
Verrouillage standard

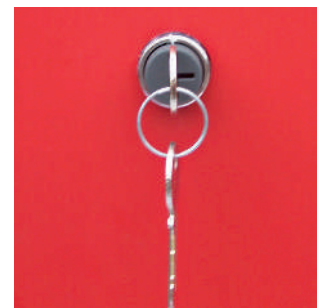

Cerradura estándar /
Standard lock /
Verrouillage standard



Cierre por resbalón /
Easy lock /
Fermeture par glissement

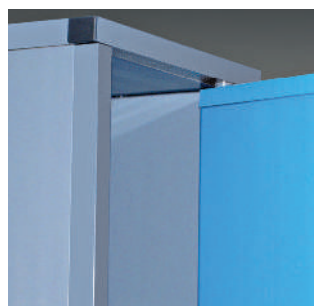

Puerta pivotante /
Hinging door /
Porte pivotante



1/2 estante y barra de colgar /
Shelve and holding rail /
Étagère et garde-robe



Pulsera numerada /
Numbered bracelet /
Bracelet numéree

GAMA 300

Cerradura de tipo pitones con 3.120 n° de combinaciones.
Cierre central y posibilidad de amaestramiento.
Color carcás en gris.
Color de la puerta en azul, rojo, beige o gris claro.

Material resinas de polivinilo.
Patás regulables de 13 a 18 cms.
Clasificación M1 según norma UNE 23727.

GAMA 300





Cerradura de tipo pitones con 3.120 n° de combinaciones.
 Cierre central y posibilidad de amaestramiento.
 Color carcás en gris.
 Color de la puerta en azul, rojo, beige o gris claro.

Material resinas de polivinilo.
 Patás regulables de 13 a 18 cms.
 Clasificación M1 según norma UNE 23727.

GAMA 300

Cerradura de tipo pitones con 3.120 n° de combinaciones.
 Cierre central y posibilidad de amaestramiento.
 Color carcás en gris.
 Color de la puerta en azul, rojo, beige o gris claro.

Material resinas de polivinilo.
 Patás regulables de 13 a 18 cms.
 Clasificación M1 según norma UNE 23727.

	Módulo Module Module	Puerta Door Porte	N° de Puertas N° of doors N° de portes	Medidas exterior total Total external size Dimension extérieure totale	Hueco útil por taquilla Useful space Creux utile	Ref.	Euros	Accesorios incluidos Accessories included Accessoires inclus
	M1	P1	1	29,4 x 53,7 x 191,5 cm	24,6 x 48,9 x 174 cm	K3M1P1	337,00	
	M2	P1	2	55,7 x 53,7 x 191,5 cm	24,6 x 48,9 x 174 cm	K3M2P1	608,00	
	M3	P1	3	82,2 x 53,7 x 191,5 cm	24,6 x 48,9 x 174 cm	K3M3P1	879,00	1/2 Estante y barra Shelve and holding rail
	M4	P1	4	108,7 x 53,7 x 191,5 cm	24,6 x 48,9 x 174 cm	K3M4P1	1150,00	Étagere et garderobe
	M5	P1	5	135,2 x 53,7 x 191,5 cm	24,6 x 48,9 x 174 cm	K3M5P1	1420,00	
	M6	P1	6	161,7 x 53,7 x 191,5 cm	24,6 x 48,9 x 174 cm	K3M6P1	1691,00	
	M1	P2	2	29,4 x 53,7 x 191,5 cm	24,6 x 48,9 x 85,9 cm	K3M1P2	404,00	
	M2	P2	4	55,7 x 53,7 x 191,5 cm	24,6 x 48,9 x 85,9 cm	K3M2P2	748,00	
	M3	P2	6	82,2 x 53,7 x 191,5 cm	24,6 x 48,9 x 85,9 cm	K3M3P2	1092,00	Barra de colgar Holding rail
	M4	P2	8	108,7 x 53,7 x 191,5 cm	24,6 x 48,9 x 85,9 cm	K3M4P2	1436,00	Garde-robe barre
	M5	P2	10	135,2 x 53,7 x 191,5 cm	24,6 x 48,9 x 85,9 cm	K3M5P2	1780,00	
	M6	P2	12	161,7 x 53,7 x 191,5 cm	24,6 x 48,9 x 85,9 cm	K3M6P2	2124,00	
	M1	P3	3	29,4 x 53,7 x 191,5 cm	24,6 x 48,9 x 56,5 cm	K3M1P3	470,00	
	M2	P3	6	55,7 x 53,7 x 191,5 cm	24,6 x 48,9 x 56,5 cm	K3M2P3	869,00	
	M3	P3	9	82,2 x 53,7 x 191,5 cm	24,6 x 48,9 x 56,5 cm	K3M3P3	1296,00	
	M4	P3	12	108,7 x 53,7 x 191,5 cm	24,6 x 48,9 x 56,5 cm	K3M4P3	1705,00	
	M5	P3	15	135,2 x 53,7 x 191,5 cm	24,6 x 48,9 x 56,5 cm	K3M5P3	2113,00	
	M6	P3	18	161,7 x 53,7 x 191,5 cm	24,6 x 48,9 x 56,5 cm	K3M6P3	2522,00	
	M1	P4	4	29,4 x 53,7 x 191,5 cm	24,6 x 48,9 x 41,8 cm	K3M1P4	542,00	
	M2	P4	8	55,7 x 53,7 x 191,5 cm	24,6 x 48,9 x 41,8 cm	K3M2P4	1008,00	
	M3	P4	12	82,2 x 53,7 x 191,5 cm	24,6 x 48,9 x 41,8 cm	K3M3P4	1531,00	
	M4	P4	16	108,7 x 53,7 x 191,5 cm	24,6 x 48,9 x 41,8 cm	K3M4P4	2015,00	
	M5	P4	20	135,2 x 53,7 x 191,5 cm	24,6 x 48,9 x 41,8 cm	K3M5P4	2500,00	
	M6	P4	24	161,7 x 53,7 x 191,5 cm	24,6 x 48,9 x 41,8 cm	K3M6P4	2985,00	
	M1	P5	5	29,4 x 53,7 x 191,5 cm	24,6 x 48,9 x 33 cm	K3M1P5	615,00	
	M2	P5	10	55,7 x 53,7 x 191,5 cm	24,6 x 48,9 x 33 cm	K3M2P5	1150,00	
	M3	P5	15	82,2 x 53,7 x 191,5 cm	24,6 x 48,9 x 33 cm	K3M3P5	1771,00	
	M4	P5	20	108,7 x 53,7 x 191,5 cm	24,6 x 48,9 x 33 cm	K3M4P5	2335,00	
	M5	P5	25	135,2 x 53,7 x 191,5 cm	24,6 x 48,9 x 33 cm	K3M5P5	2899,00	
	M6	P5	30	161,7 x 53,7 x 191,5 cm	24,6 x 48,9 x 33 cm	K3M6P5	3462,00	

NOTA: Las taquillas se suministran desmontadas, techo, suelo, laterales y fondo. El ensamblaje se realiza, encajando los dos laterales al fondo y uniendo mediante 12 tornillos el techo, el suelo y la puerta (tiempo 5 min.).

NOTE: All lockers are provided disassembled, roof, walls and floor. The assembling works fitting both walls to the back-side and fixing through 12 screws the roof, floor and door (5 min.).

NOTE: Toutes les casiers sont fournis sans monter, plafond, sol, fond et murs. Pour de monter, encaisser des murs au le fond et ajuster moyennant 12 visés au plafond, sol et porte (5 min.).

Accesorios / Accessories / Accessoires

Precio PVP / Retail price / Prix conseillé

1/2 Estante / 1/2 Shelve / 1/2 Étagère	21,00
1 Estante / 1 Shelve / 1 Étagère	29,00
Barra de colgar / Holding rail / Garde-robe	12,50
Patas regulables / Adjustable foot / Pied réglable	<i>incluidas / included / inclus</i>
Zócalo 1 módulo lateral / Baseboard 1 lateral module / Plinthe 1 module central	33,00
Zócalo módulo central / Baseboard central module / Plinthe module central	11,00
Muñequera llave numerada / Numbered bracelet / Braclet numérée	12,50
Numeración placa de 30 x15 / Sheet numeration of 30 x 15 / Numération plaque 30 x 15	6,50
Techo inclinado 1 módulo laterales / Sloping roof lateral modules / Plafond incliné module lateral	71,00
Techo inclinado 1 módulo central / Sloping roof central modules / Plafond incliné module central	36,00
Cerradura de seguridad / Safe lock / Verrouillage de sécurité	<i>CONSULTAR / CONSULT / CONSULTER</i>
Cerradura de monedas / Coins lock / Verrouillage avec des pièces	31,00

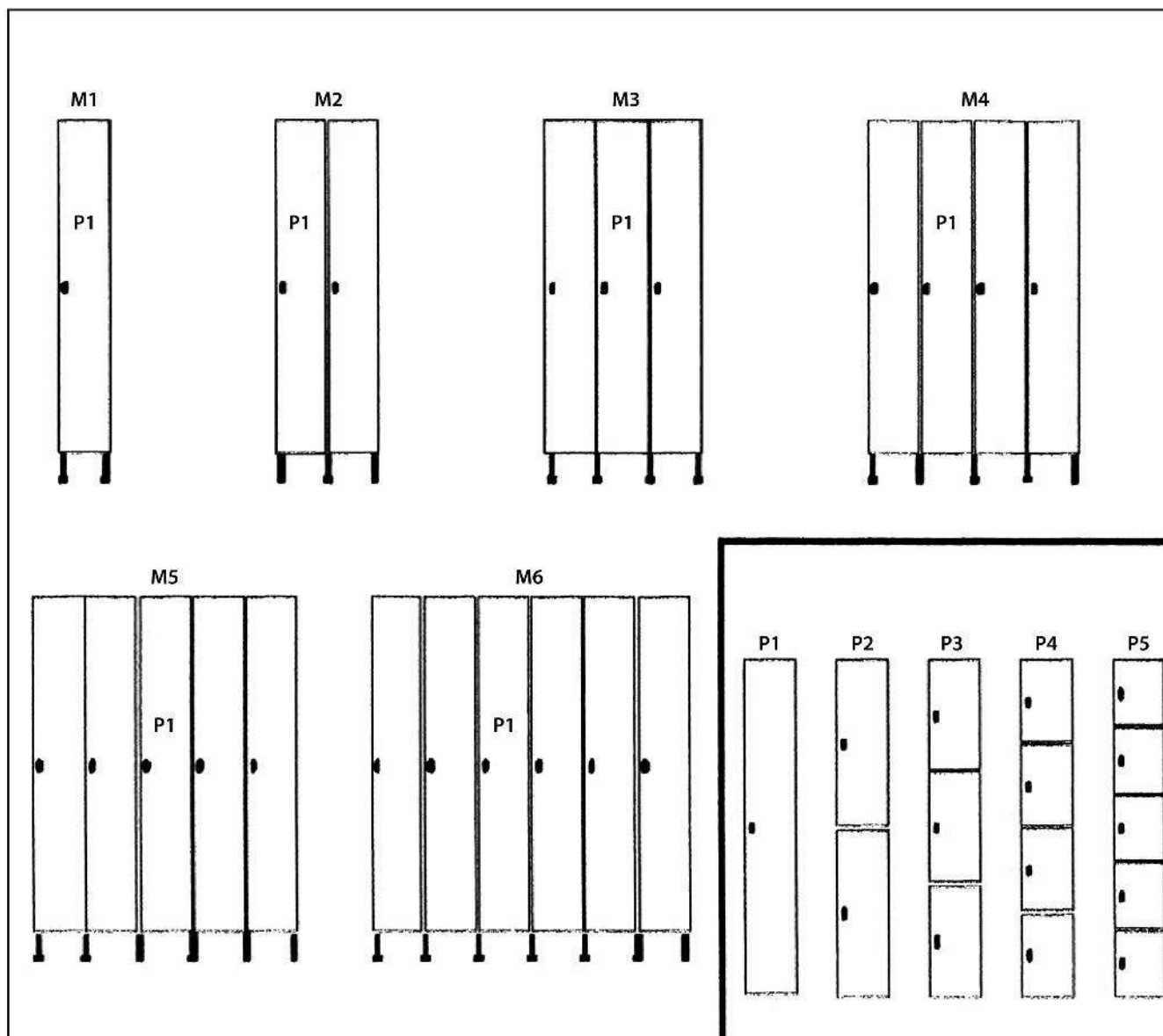

GAMA 400

Cerradura de tipo pitones con 3.120 n° de combinaciones.
Cierre central y posibilidad de amaestramiento.
Color carcás en gris.
Color de la puerta en azul, rojo, beige o gris claro.

Material resinas de polivinilo.
Patás regulables de 13 a 18 cms.
Clasificación M1 según norma UNE 23727.

GAMA 400

Cerradura de tipo pitones con 3.120 n° de combinaciones.
 Cierre central y posibilidad de amaestramiento.
 Color carcás en gris.
 Color de la puerta en azul, rojo, beige o gris claro.

Material resinas de polivinilo.
 Patás regulables de 13 a 18 cms.
 Clasificación M1 según norma UNE 23727.

GAMA 400

Cerradura de tipo pitones con 3.120 n° de combinaciones.
 Cierre central y posibilidad de amaestramiento.
 Color carcás en gris.
 Color de la puerta en azul, rojo, beige o gris claro.

Material resinas de polivinilo.
 Patás regulables de 13 a 18 cms.
 Clasificación M1 según norma UNE 23727.

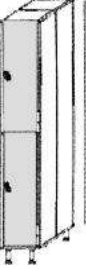
	Módulo Module Module	Puerta Door Porte	N° de Puertas N° of doors N° de portes	Medidas exterior total Total external size Dimension extérieure totale	Hueco útil por taquilla Useful space Creux utile	Ref.	Euros	Accesorios incluidos Accessories included Accessoires inclus
	M1	P1	1	39,5 x 53,7 x 191,5 cm	34,6 x 48,9 x 174 cm	K4M1P1	357,00	
	M2	P1	2	76,2 x 53,7 x 191,5 cm	34,6 x 48,9 x 174 cm	K4M2P1	647,00	
	M3	P1	3	112,9 x 53,7 x 191,5 cm	34,6 x 48,9 x 174 cm	K4M3P1	938,00	1/2 Estante y barra Shelve and holding rail
	M4	P1	4	149,6 x 53,7 x 191,5 cm	34,6 x 48,9 x 174 cm	K4M4P1	1228,00	Étagere et garde- robe
	M5	P1	5	186,3 x 53,7 x 191,5 cm	34,6 x 48,9 x 174 cm	K4M5P1	1519,00	
	M6	P1	6	223 x 53,7 x 191,5 cm	34,6 x 48,9 x 174 cm	K4M6P1	1811,00	
	M1	P2	2	39,5 x 53,7 x 191,5 cm	34,6 x 48,9 x 85,9 cm	K4M1P2	425,00	
	M2	P2	4	76,2 x 53,7 x 191,5 cm	34,6 x 48,9 x 85,9 cm	K4M2P2	789,00	
	M3	P2	6	112,9 x 53,7 x 191,5 cm	34,6 x 48,9 x 85,9 cm	K4M3P2	1154,00	Barra de colgar Holding rail
	M4	P2	8	149,6 x 53,7 x 191,5 cm	34,6 x 48,9 x 85,9 cm	K4M4P2	1518,00	Garde-robe barre
	M5	P2	10	186,3 x 53,7 x 191,5 cm	34,6 x 48,9 x 85,9 cm	K4M5P2	1882,00	
	M6	P2	12	223 x 53,7 x 191,5 cm	34,6 x 48,9 x 85,9 cm	K4M6P2	2247,00	
	M1	P3	3	39,5 x 53,7 x 191,5 cm	34,6 x 48,9 x 56,5 cm	K4M1P3	492,00	
	M2	P3	6	76,2 x 53,7 x 191,5 cm	34,6 x 48,9 x 56,5 cm	K4M2P3	913,00	
	M3	P3	9	112,9 x 53,7 x 191,5 cm	34,6 x 48,9 x 56,5 cm	K4M3P3	1372,00	
	M4	P3	12	149,6 x 53,7 x 191,5 cm	34,6 x 48,9 x 56,5 cm	K4M4P3	1806,00	
	M5	P3	15	186,3 x 53,7 x 191,5 cm	34,6 x 48,9 x 56,5 cm	K4M5P3	2240,00	
	M6	P3	18	223 x 53,7 x 191,5 cm	34,6 x 48,9 x 56,5 cm	K4M6P3	2696,00	
	M1	P4	4	39,5 x 53,7 x 191,5 cm	34,6 x 48,9 x 41,8 cm	K4M1P4	567,00	
	M2	P4	8	76,2 x 53,7 x 191,5 cm	34,6 x 48,9 x 41,8 cm	K4M2P4	1056,00	
	M3	P4	12	112,9 x 53,7 x 191,5 cm	34,6 x 48,9 x 41,8 cm	K4M3P4	1621,00	
	M4	P4	16	149,6 x 53,7 x 191,5 cm	34,6 x 48,9 x 41,8 cm	K4M4P4	2136,00	
	M5	P4	20	186,3 x 53,7 x 191,5 cm	34,6 x 48,9 x 41,8 cm	K4M5P4	2650,00	
	M6	P4	24	223 x 53,7 x 191,5 cm	34,6 x 48,9 x 41,8 cm	K4M6P4	3187,00	
	M1	P5	5	39,5 x 53,7 x 191,5 cm	34,6 x 48,9 x 33 cm	K4M1P5	641,00	
	M2	P5	10	76,2 x 53,7 x 191,5 cm	34,6 x 48,9 x 33 cm	K4M2P5	1202,00	
	M3	P5	15	112,9 x 53,7 x 191,5 cm	34,6 x 48,9 x 33 cm	K4M3P5	1876,00	
	M4	P5	20	149,6 x 53,7 x 191,5 cm	34,6 x 48,9 x 33 cm	K4M4P5	2474,00	
	M5	P5	25	186,3 x 53,7 x 191,5 cm	34,6 x 48,9 x 33 cm	K4M5P5	3072,00	
	M6	P5	30	223 x 53,7 x 191,5 cm	34,6 x 48,9 x 33 cm	K4M6P5	3693,00	

NOTA: Las taquillas se suministran desmontadas, techo, suelo, laterales y fondo. El ensamblaje se realiza, encajando los dos laterales al fondo y uniendo mediante 12 tornillos el techo, el suelo y la puerta (tiempo 5 min.).

NOTE: All lockers are provided disassembled, roof, walls and floor. The assembling works fitting both walls to the back-side and fixing through 12 screws the roof, floor and door (5 min.).

NOTE: Toutes les casiers sont fournis sans monter, plafond, sol, fond et murs. Pour de monter, encaisser des murs au le fond et ajuster moyennant 12 visés au plafond, sol et porte (5 min.).

GAMA 400 D Vertical
Cerradura de tipo pitones con 3.120 n° de combinaciones.
Cierre central y posibilidad de amaestramiento.
Color carcás en gris.
Color de la puerta en azul, rojo, beige o gris claro.



Material resinas de polivinilo.
Patás regulables de 13 a 18 cms.
Clasificación M1 según norma UNE 23727.

GAMA 400 D Vertical
 Cerradura de tipo pitones con 3.120 n° de combinaciones.
 Cierre central y posibilidad de amaestramiento.
 Color carcás en gris.
 Color de la puerta en azul, rojo, beige o gris claro.

Material resinas de polivinilo.
 Patás regulables de 13 a 18 cms.
 Clasificación M1 según norma UNE 23727.

GAMA 400 D Vertical
 Cerradura de tipo pitones con 3.120 n° de combinaciones.
 Cierre central y posibilidad de amaestramiento.
 Color carcás en gris.
 Color de la puerta en azul, rojo, beige o gris claro.

Material resinas de polivinilo.
 Patás regulables de 13 a 18 cms.
 Clasificación M1 según norma UNE 23727.

	Módulo Module Module	Puerta Door Porte	N° de Puertas N° of doors N° de portes	Medidas exterior total Total external size Dimension extérieure totale	Hueco útil por taquilla Useful space Creux utile	Ref.	Euros	Accesorios incluidos Accessories included Accessoires inclus
	M1	P1	1	39,5 x 53,7 x 191,5 cm	16,2 x 48,9 x 174 cm	KD4M1P1	445,00	
	M2	P1	2	76,2 x 53,7 x 191,5 cm	16,2 x 48,9 x 174 cm	KD4M2P1	823,00	Estante, barra y división vertical Shelve, rail and vertical wall Étagèr, barre et séparateur
	M3	P1	3	112,9 x 53,7 x 191,5 cm	16,2 x 48,9 x 174 cm	KD4M3P1	1200,00	
	M4	P1	4	148,7 x 53,7 x 191,5 cm	16,2 x 48,9 x 174 cm	KD4M4P1	1579,00	
	M5	P1	5	186,3 x 53,7 x 191,5 cm	16,2 x 48,9 x 174 cm	KD4M5P1	1957,00	
	M6	P1	6	223 x 53,7 x 191,5 cm	16,2 x 48,9 x 174 cm	KD4M6P1	2337,00	
	M1	P2	2	39,5 x 53,7 x 191,5 cm	16,2 x 48,9 x 85,9 cm	KD4M1P2	518,00	
	M2	P2	4	75,7 x 53,7 x 191,5 cm	16,2 x 48,9 x 85,9 cm	KD4M2P2	974,00	
	M3	P2	6	112,2 x 53,7 x 191,5 cm	16,2 x 48,9 x 85,9 cm	KD4M3P2	1430,00	
	M4	P2	8	148,7 x 53,7 x 191,5 cm	16,2 x 48,9 x 85,9 cm	KD4M4P2	1887,00	
	M5	P2	10	155,2 x 53,7 x 191,5 cm	16,2 x 48,9 x 85,9 cm	KD4M5P2	2344,00	
	M6	P2	12	221,7 x 53,7 x 191,5 cm	16,2 x 48,9 x 85,9 cm	KD4M6P2	2800,00	

NOTA: Las taquillas se suministran desmontadas, techo, suelo, laterales y fondo. El ensamblaje se realiza, encajando los dos laterales al fondo y uniendo mediante 12 tornillos el techo, el suelo y la puerta (tiempo 5 min.).

NOTE: All lockers are provided disassembled, roof, walls and floor. The assembling works fitting both walls to the back-side and fixing through 12 screws the roof, floor and door (5 min.).

NOTE: Toutes les casiers sont fournis sans monter, plafond, sol, fond et murs. Pour de monter, encaisser des murs au le fond et ajuster moyennant 12 visés au plafond, sol et porte (5 min.).

Accesorios / Accessories / Accessoires

Precio PVP / Retail price / Prix conseillé

1/2 Estante / 1/2 Shelve / 1/2 Étagère	22,00
1 Estante / 1 Shelve / 1 Étagère	30,00
Barra de colgar / Holding rail / Garde-robe	13,50
Patás regulables / Adjustable foot / Pied réglable	incluidas / included / inclus
Zócalo 1 módulo lateral / Baseboard 1 lateral module / Plinthe 1 module central	34,00
Zócalo módulo central / Baseboard central module / Plinthe module central	11,00
Muñequera llave numerada / Numbered bracelet / Braclet numéree	12,50
Numeración placa de 30 x 15 / Sheet numeration of 30 x 15 / Numération plaque 30 x 15	6,50
Techo inclinado 1 módulo laterales / Sloping roof lateral modules / Plafond incliné module lateral	71,00
Techo inclinado 1 módulo central / Sloping roof central modules / Plafond incliné module central	36,00
Cerradura de seguridad / Safe lock / Verrouillage de sécurité	CONSULTAR / CONSULT / CONSULTER
Cerradura de monedas / Coins lock / Verrouillage avec des pièces	31,00

NOTA: Las taquillas se suministran desmontadas, techo, suelo, laterales y fondo. El ensamblaje se realiza, encajando los dos laterales al fondo y uniendo mediante 12 tornillos el techo, el suelo y la puerta (tiempo 5 min.).

NOTE: All lockers are provided disassembled, roof, walls and floor. The assembling works fitting both walls to the back-side and fixing through 12 screws the roof, floor and door (5 min.).

NOTE: Toutes les casiers sont fournis sans monter, plafond, sol, fond et murs. Pour le monter, encaisser des murs au le fond et ajuster moyennant 12 visés au plafond, sol et porte (5 min.).

Recambios

Carteles portaprecios, Guantes acero-inox, Indicadores de turno, Grifos ducha, Soldadores de bolsa, Esterilizadores, Máquinas retractilar, Máquinas cierra bolsas, Hamburgueseras, Máquinas cierra bolsas, Etiquetadoras, Abrelatas, Exterminadores-tubos.

Spare Parts

Tag holders, Stainless steel gloves, Queue indicators, Shower taps, Bag sealers, Sterilisers, Wrapping machines, Burger presses, Labellers, Can opener, Insect exterminators-tubes.

Pieces de Rechange

Affiches porte-prix, Gants d'inox, Indicateurs de tour, Robinets douche, Scelleuse de sacs, Stérilisateurs, Machines à retractiler, Machine ferme sacs, Hachoirs, Étiqueteusses, Ouvrebottes, Exterminateurs d'insectes-tubes.

Números

Numbers

Numerós

Ref.	Para For Pour	Euros
C-103	C-26	1,00
C-104	C-27, C-28, C-50	1,00
C-108	C-19, C-20, C-21, C-25, C-35, C-40, C-41, C-52	1,15
C-110	C-31, C-32, C-33	2,00
C-115	C-30, C-34	3,50

Números (Caja 24 juegos números / Ref. C-121 números dobles)

Numbers (Box with 24 sets of numbers / Ref. C-121 double numbers)

Numerós (Boite avec 24 jeux de numéros / Ref. C-121 numéros doubles)

Ref.	Para For Pour	Euros
C-121	C-44	30,00
C-122	C-42	23,00

GUANTES ACERO INOXIDABLE | STAINLESS STEEL GLOVES | *GANTS D'ACIER INOX*

Banda plástico

Plastic band

Bande plastique

Ref.	Color Colour Couleur	Euros
A-1050-B	●	5,00
A-1051-B	●	5,00
A-1052-B	○	5,00

Ref.	Color Colour Couleur	Euros
A-1053-B	●	5,00
A-1054-B	●	5,00
A-1055-B	●	5,00

INDICADORES DE TURNO | QUEUE INDICATORS | *INDICATEURS DE TOUR*

Soporte pared

Wall holder

Support par mur

Ref.	Para For Pour	Euros
ET-108	ET-1	4,50

Caja control

Control pad with cable

Télécommande avec fil pour

Ref.	Para For Pour	Euros
IT-103	IT-4, IT-6	50,00

Caja control

Control pad with cable

Commande avec fil pour

Ref.	Para For Pour	Euros
IT-110	IT-8	50,00

Mando a distancia

Remote control

Télécommande

Ref.	Para For Pour	Euros
IT-105	IT-5-MD	50,00

Mando a distancia

Remote control

Télécommande

Ref.	Para For Pour	Euros
IT-105-	IT-7-MD	50,00

Mando a distancia con visor

Remote control

Télécommande

Ref.	Para For Pour	Euros
IT-105-V	IT-5-MDV	74,00

Mando a distancia (1 función)

Remote control (1 function)

Télécommande (1 fonction)

Ref.	Para For Pour	Euros
IT-107	IT-4-MD, IT-6-MD, IT-5-MD	45,00

Mando a distancia (2 funciones)

Remote control (2 functions)

Télécommande (2 fonctions)

Ref.	Para For Pour	Euros
IT-106	IT-6-MD, IT-8-MD	55,00

Mando a distancia (3 funciones)

Remote control (3 functions)

Télécommande (3 fonctions)

Ref.	Para For Pour	Euros
IT-109	IT-4-MD	59,00



Resistencia y teflón

Heating element and teflon cloth

Élément coupant et téflon

Ref.	Para For Pour	Euros
SB-201	SB-200	10,00
SB-301	SB-300	10,00
SB-401	SB-400	10,00
SB-501	SB-500	11,00

Termóstato

Thermostat

Thermostat

Ref.	Para For Pour	Euros
SB-202	SB-200	47,00
SB-302	SB-300	47,00
SB-402	SB-400	47,00
SB-502	SB-500	47,00

Resistencia

Heating element

Élément coupant

Ref.	Para For Pour	Euros
SB-451	SBP-450	14,00
SB-601	SBP-600, SBM-600, SB-600	15,00
SB-1001	SB-1000	20,00

Resistencia

Resistance

Résistance

Ref.	Para For Pour	Euros
SBPA-451	SBPA-450	21,00
SBPA-601	SBPA-600	24,00

Rollo teflón

Teflon cloth roll

Rouleau de téflon

Ref.	Para For Pour	Euros
SB-602	SBP-450/600, SBM-600	42,00

ESTERILIZADORES | STERILISERS | STÉRILISATEURS

Circuito eléctrico completo temporizado

Complete electric circuit

Circuit électrique complet

Ref.	Para For Pour	Euros
EC-710	EC-1, EC-55, EC-105	166,00

Base conexión macho con toma red + portafusible

Plug connection with power point + fuse carrier

Base connection prise + portafusible

Ref.	Para For Pour	Euros
EC-711	EC-1, EC-55, EC-105	29,00

Pulsador redondo para encendido

On button

Bouton de branchement

Ref.	Para For Pour	Euros
EC-712	EC-1, EC-55, EC-105	4,00

ESTERILIZADORES | STERILISERS | STÉRILISATEURS

Cable de corriente

Power cable

Cable courant électrique

Ref.	Para For Pour	Euros
EC-713	EC-1, EC-55, EC-105	6,00

Fusible

Fuse

Fusible

Ref.	Para For Pour	Euros
EC-714	EC-1, EC-55, EC-105	1,00

Lámpara ozono con soporte

Ozone lamp with stand

Lampe d'ozone avec support

Ref.	Para For Pour	Euros
EC-715	EC-1, EC-55, EC-105	25,00

Lámpara UV germicida 15 W

UV germicide lamp 15 W

Lampe UV germicide 15 W

Ref.	Para For Pour	Euros
ECU-15	ECU-25, ECU-50, ECU-100	41,00

Resistencia de corte

Heating element

Élément coupant

Ref.	Para For Pour	Euros
MR-201	MR-2, MR-4	39,50
MR-201-ECO	MR-4-ECO	36,00
MR-206	MR-4-500	41,00
MR-206-ECO	MR-4-500-ECO	38,00

Termostato

Thermostat

Thermostat

Ref.	Para For Pour	Euros
MR-203	MR-4, MR-4-500	22,00

Interruptor general

General switch

Interrupteur général

Ref.	Para For Pour	Euros
MR-207	MR-4, MR-4-500	17,00

Resistencia de corte

Heating element

Élément coupant

Ref.	Para For Pour	Euros
MR-210	MR-4-600	43,50
MR-215	MR-3	29,00

Rueda termostato

Thermostat wheel

Roulette de thermostat

Ref.	Para For Pour	Euros
MR-204	MR-4, MR-4-500	7,00

Interruptor placa de calor o resistencia

Heat plate and heating element on/off switch

Interrupteur pour element coupant et plaque de chauffage

Ref.	Para For Pour	Euros
MR-208	MR-4, MR-4-500	6,00

Placa de calor

Heat plate

Plaque de chauffage

Ref.	Para For Pour	Euros
MR-202	MR-4, MR-4-500	75,00
MR-202-ECO	MR-4-ECO	55,00

Portafusible con fusible

Fuse carrier with fuse

Portafusible avec fusible

Ref.	Para For Pour	Euros
MR-205	MR-4, MR-4-500	4,00

Piloto señalización

Sign light

Lumineux

Ref.	Para For Pour	Euros
MR-209	MR-4, MR-4-500	6,50

MÁQUINAS CIERRA BOLSAS | BAG SEALERS | MACHINE FERME SACS

Rueda rollo

Roll wheel

Roulette rouleau

Ref.	Para For Pour	Euros
CB-10	CB-101	2,50

Rueda rollo

Roll wheel

Roulette rouleau

Ref.	Para For Pour	Euros
CB-11	CB-606	2,50

HAMBURGUESERAS | BURGUER PRESSES | HACHOIRS

Palanca prensa

Press lever

Levier presse

Ref.	Para For Pour	Euros
MH-101	MH-2	62,00

Pala doble

Double slice

Pelle double

Ref.	Para For Pour	Euros
MH-102	MH-2	62,00
MH-105	MH-3, MH-4	50,00

Pala doble redonda

Round double slice

Pelle double ronde

Ref.	Para For Pour	Euros
MH-107	MH-5	50,00
MH-6-1	MH-6	50,00
MH-7-1	MH-7	55,00
MH-8-1	MH-8	65,00
MH-9-1	MH-9	65,00

Pala ovalada

Oval shovel

Pelle oval

Ref.	Para For Pour	Euros
MH-111	MH-1	12,00

Pala redonda

Round shovel

Pelle ronde

Ref.	Para For Pour	Euros
MH-112	MH-1-R	13,00

Muelle elevación placa

Elevator sheet spring

Ressort elevateur plaque

Ref.	Para For Pour	Euros
MH-104	MH-2	5,00
MH-110	MH-3, MH-4	5,00

Muelle elevación brazo

Elevator arm spring

Ressort elevateur bras

Ref.	Para For Pour	Euros
MH-103	MH-2	5,00

Muelle elevación brazo izquierdo

Elevator left arm spring

Ressort elevateur bras gauche

Ref.	Para For Pour	Euros
MH-108	MH-3, MH-4	5,00

Muelle elevación brazo derecho

Elevator right arm spring

Ressort elevateur bras droite

Ref.	Para For Pour	Euros
MH-109	MH-3, MH-4	5,00

ETIQUETADORAS | LABELLERS | ÉTIQUETEUSES

Rodillo tinta

Ink roller

Rouleau encre

Ref.	Para For Pour	Euros
E-110	E-5, E-6	4,00

Rodillo tinta

Ink roller

Rouleau encre

Ref.	Para For Pour	Euros
E-110-ECO	E-5-ECO, E-6-ECO	4,00

Cuchilla

Blade

Lame

Ref.	Para For Pour	Euros
A-70-1	A-70	7,50

Roldana o rueda de arrastre

Wheel for drag

Roulette pour traîner

Ref.	Para For Pour	Euros
A-70-2	A-70	12,50

Muelle de roldana

Spring of A-70-2 for ref. A-70

Ressort de A-70-2 pour réf. A-70

Ref.	Para For Pour	Euros
A-70-3	A-70	5,50

ABRELATAS | CAN OPENER | OUVRE-BOÎTES

Tubo

Tube

Tube

Ref.	Tipo Type	Para For Pour	Euros
Z-10	10 W	Z-420-MD	11,00
Z-11	11 W	Z-600	11,00
Z-15	15 W	Z-700, Z-930, Z-950, Z-430-MD	12,50
Z-18	18 W	Z-918, Z-920	13,00
Z-20	20 W	Z-740, Z-840, Z-960	13,50
Z-20-F	18 W	Z-440-MD	14,00
Z-40	40 W	Z-780, Z-880	16,00

Tubo, forma U

Tube, U form

Tube, forme d'U

Ref.	Tipo Type	Para For Pour	Euros
Z-11-U	11 W	Z-151	9,00

Lámpara bajo consumo

Low energy lamp

Lampe de basse consommation

Ref.	Tipo Type	Para For Pour	Euros
Z-21	20 W	Z-911, Z-918	13,00

0-9					
0010.100	168	3250.300-V	170	A-20	144
0015.065	168	3400.300	170	A-200	86
0151.310	162	3500.300	170	A-2001	177
0151.355	162	3900.700	171	A-200-13	86
0151.395	162	3900.750	171	A-200-13X Circonio	86
0170.155	162	3900.995	171	A-2002	177
0170.185	162	4000.100	164	A-2003	177
0170.210	162	4000.150	164	A-200-33	86
0170.260	162	4000.200	164	A-2004	177
0170.310	162	4000.250	164	A-21	173
0170.355	162	4000.300	164	A-22	173
0170.395	162	4010.150	164	A-23	144
0370.165	162	4020.300	164	A-24	144
0370.195	162	4050.180	164	A-25	173
0370.225	162	4100.150	165	A-26	144
0425.130	162	4100.200	164	A-27	142
0425.150	162	4100.250	164	A-28	142
0430.150	163	4101.250	165	A-29	142
0500.305	163	4102.230	165	A-3	142
0521.250	164	4105.180	165	A-3000	178
0521.300	164	4120.250	164	A-3005	178
0526.250	163	4120.300	164	A-30-100	18
0526.300	163	4200.150	165	A-30-100-I	18
0540.250	163	4200.200	165	A-30-50	18
0540.305	163	4200.250	165	A-30-50-I	18
0560.250	168	4200.280	165	A-30-70	18
0560.310	168	4300.270	165	A-30-70-I	18
0575.250	168	A		A-35-11	72
0575.300	168	A-1	41	A-35-13	72
0575.360	168	A-1000	176	A-35-15	72
0600.300	165	A-1001	176	A-35-26	72
0600.350	165	A-1010	176	A-36-11	72
0701.320	163	A-1011	176	A-36-13	72
0701.350	163	A-1012	176	A-36-15	72
0701.370	163	A-1013	176	A-37	139
0720.350	163	A-1014	176	A-38-G	181
0720.380	163	A-1015	176	A-38-M	181
0775.190	163	A-1020	176	A-38-P	181
0801.230	166	A-1021	176	A-39-G	181
0801.250	166	A-1022	176	A-39-M	181
0801.290	166	A-1023	176	A-39-P	181
0820.240	166	A-1024	176	A-41	17
0820.260	166	A-1050	176	A-4-11	144
0840.320	166	A-1050-B	198	A-4-14	144
0850.220	166	A-1051	176	A-4-16	144
0850.250	166	A-1051-B	198	A-42	17
0901.290	167	A-1052	176	A-4-20	144
0901.310	167	A-1052-B	198	A-4-24	144
0905.290	167	A-1053	176	A-43	17
0905.310	167	A-1053-B	198	A-43-P	17
1000.305	167	A-1054	176	A-44	17
1000.450	167	A-1054-B	198	A-44-P	17
1001.260	167	A-1055	176	A-46	17
1001.290	167	A-1055-B	198	A-47	17
1001.320	167	A-1110	176	A-48-18	16
1701.135	168	A-1111	176	A-48-22	16
1705.150	168	A-11-110	180	A-48-26	16
2002.250	167	A-1112	176	A-49	145
2002.310	167	A-11-120-AZ	180	A-50	145
2401.230	168	A-1113	176	A-50-15	145
2401.260	168	A-1114	176	A-50-25	145
2460.400	174	A-1115	176	A-50-30	145
2460.450	174	A-11-90	180	A-51	173
2460.500	174	A-11-90-AZ	180	A-5-10	144
2476.420	174	A-11-90-N	180	A-5-12	144
2476.450	174	A-11-90-R	180	A-5-16	144
2476.500	174	A-12	181	A-52	173
2500.330	174	A-13	153	A-5-20	144
2500.450	174	A-14	173	A-5-24	144
2500.600	174	A-15	146	A-53	173
2526.000	168	A-16	172	A-530	132
3000.200	169	A-17-B	180	A-531	132
3000.250	169	A-17-BAZ	180	A-54	173
3000.300	169	A-17-BR	180	A-540	133
3050.300	169	A-17-BU	180	A-550	133
3100.300	169	A-17-BV	180	A-5548	177
3150.300	169	A-17-F	180	A-5548-13	177
3200.300-A	170	A-17-N	180	A-555	133
3200.300-AZ	170	A-17-NBU	180	A-56	174
3200.300-N	170	A-17-NV	180	A-57	18
3200.300-R	170	A-17-P	180	A-6	172
3200.300-V	170	A-18	174	A-65	175
3250.300-A	170	A-19	153	A-70	175
3250.300-AZ	170	A-198	85	A-70-1	201
3250.300-N	170	A-198-1	85	A-70-2	201
3250.300-R	170	A-19-EX	153	A-70-3	201
		A-2	174	A-75	94
				A-76	95
				A-760-10	178
				A-760-8	178
				A-760-9	178
				A-77	95
				A-8	144
				A-80	2
				A-81	2
				A-81-1	2
				A-82	182
				A-83	182
				A-84	182
				A-85	182
				A-8533	177
				A-86	182
				A-8633	177
				A-87	182
				A-88	182
				A-89	182
				A-90	113
				A-95	113
				A-9-76	179
				A-9-76M	179
				B	
				BA-3	48
				BA-5	48
				BAC-1	155
				BAL-1	155
				BB-1	47
				BB-10	47
				BB-2	47
				BB-3	47
				BB-4	47
				BB-5	47
				BB-6	47
				BB-7	47
				BB-8	47
				BB-9	47
				BBP-1	47
				BBP-2	47
				BBP-3	47
				BBP-4	47
				BBP-5	47
				BC-0	49
				BC-0-N	49
				BC-1	49
				BC-1-N	49
				BC-2	49
				BC-2-N	49
				BC-3	49
				BC-3-N	49
				BC-4	49
				BC-4-N	49
				BC-5	49
				BCR-5	49
				BCR-5-N	49
				BI-11	50
				BI-12	50
				BI-13	50
				BI-14	50
				BI-15-B	155
				BI-15-N	155
				BI-15-R	155
				BI-21	50
				BI-21-N	50
				BI-22	50
				BI-22-N	50
				BI-23	50
				BI-23-N	50
				BP-10063-N	58
				BP-14330-N	60
				BP-1946-N	60
				BP-4013-N	58
				BP-5355-N	58
				BP-5356-N	59
				BP-5869-N	59
				BP-5921-N	59
				BP-6661-N	58
				BP-6665-N	58
				BP-6670-N	58
				BP-6675-N	58
				BP-6901-N	60
				BP-6960-N	58
				BP-9327-N	60
				BPA-15-50-N	57
				BPA-22G-50-N	56
				BPA-22P-50-N	57

B-C

BPA-45-50-N	56	BVX-1525	95	C-31	38	C-91	28
BPA-90-50-N	57	BVX-1535	95	C-310	22	C-92	28
BPA-ANFI	57	BVX-1545	95	C-311	23	C-93	34
BPA-TD-50-N	57	BVX-2020	95	C-312	23	C-94	34
BPA-TI-50-N	57	BVX-2030	95	C-313	23	C-95	34
BPB-10569-N	59	BVX-2040	95	C-314	23	C-96	34
BPB-17068-N	59	BVX-2535	95	C-315	23	C-97	28
BPB-17069-N	60	BVX-3040	95	C-317	23	C-97-N	28
BPB-17070-N	60	BVX-3050	95	C-32	38	C-98	28
BPB-17071-N	60	BVXC-200300	95	C-320	32	C-98-N	28
BPB-25140	59	BVX-R20	95	C-321	25	C-99	29
BPB-9232-N	59	BX-4	46	C-33	38	CB-10	200
BPC-22860-N	61	BX-5	46	C-34	32	CB-101	150
BPC-22861-N	61	BX-6	46	C-35	32	CB-11	200
BPC-22866-N	61	BX-9	46	C-35-K	32	CB-606	150
BPC-24544-N	61	BXP-2	46	C-38	25	CB-800	150
BP-GN 1/1-50-N	54	BXP-3	46	C-38-B	27	CC-10	45
BP-GN 1/2-50-N	54	BXP-4	46	C-39	29	CC-100	45
BP-GN 1/3-17-N	54	BXP-5	46	C-40	32	CC-12	45
BP-GN 1/3-50-N	54	BZ-1	46	C-41	32	CC-14	44
BP-GN 1/4-17-N	54	BZ-10	46	C-42-AZ	30	CC-15	45
BP-GN 1/4-50-N	54	BZ-2	46	C-42-B	31	CC-16	45
BP-GN 1/5-17-N	54	BZ-3	46	C-42-C	31	CC-19	45
BP-GN 1/5-50-N	54	BZ-4	46	C-42-G	29	CC-20	45
BP-GN 1/6-50-N	54	BZ-5	46	C-42-GAZ	29	CC-21	45
BP-GN 1/9-50-N	54	BZ-6	46	C-42-GM	29	CC-32	44
BP-GN 2/4-17-N	54	BZP-1	46	C-42-GR	29	CC-33	45
BP-GN 2/5-17-N	54	BZP-2	46	C-42-R	31	CC-40	45
BP-GN 3/4-17-N	54	BZP-3	46	C-42-V	31	CC-60	45
BP-GN 3/4-50-N	54	BZP-4	46	C-43	31	CC-9	45
BP-GN 5/4-40-N	54	C		C-43-A	31	CCT-39	45
BP-GN-1/1-17-N	54	C-1	35	C-44-AZ	30	CCT-40	45
BP-GN-1/2-17-N	54	C-10	24	C-44-B	30	CCT-60	45
BPR-1/1-N	55	C-100	29	C-44-BAZ	30	CH-1	45
BPR-1/2-N	55	C-103	198	C-44-BR	30	CH-10	44
BPR-1/3-N	55	C-104	198	C-44-BV	30	CH-100	44
BPR-1/4-N	55	C-108	198	C-44-C	30	CH-12	44
BPR-1/5-N	55	C-10-AZ	24	C-44-M	30	CH-18	44
BPT-1/1-T	55	C-10-B	24	C-44-R	30	CH-2	45
BPT-1/2-T	55	C-11	24	C-4-B	35	CH-3	45
BPT-1/3-T	55	C-110	198	C-4-M	35	CH-30	44
BPT-1/4-T	55	C-115	198	C-500	39	CH-4	45
BPT-1/5-T	55	C-11-AZ	24	C-51	31	CH-40	44
BPT-2/5-T	55	C-11-B	24	C-56	31	CH-50	44
BPT-3/4-T	55	C-121	198	C-57	37	CH-6	45
BPT-4015	58	C-122	198	C-62	38	CH-7	45
BPT-6680	58	C-13	26	C-63	38	CH-75	44
BPTR-27-20-N	55	C-130	28	C-64	38	CI-1	39
BPTR-40-20-N	55	C-131	28	C-65-AZ	24	CI-10	39
BPTR-40-50-N	55	C-132	26	C-65-AZB	27	CI-2	39
BV-140450	96	C-140	26	C-65-B	25	CI-3	39
BV-150200	96	C-141	26	C-65-BB	27	CI-4	39
BV-150250	96	C-15-N	25	C-65-R	24	CI-5	39
BV-175250	96	C-17	25	C-65-RB	27	CI-6	39
BV-180300	96	C-1-N	35	C-65-V	24	CI-7	39
BV-200200	96	C-1-P	35	C-65-VB	27	CI-8	39
BV-200250	96	C-1PN	35	C-65-VF	32	CI-9	39
BV-200300	96	C-2	29	C-66	25	CP-12	71
BV-200350	96	C-200	35	C-66-B	27	CP-12-3,5	71
BV-200400	96	C-201	35	C-67	27	CP-12-3	71
BV-250350	96	C-202	35	C-67-AZ	27	CP-12-4	71
BV-300400	96	C-203	35	C-67-R	27	CP-12-4,5	71
BV-350500	96	C-205	35	C-68	32	CP-12-5	71
BV-350600	96	C-210	36	C-69	32	CP-12-6	71
BV-400500	96	C-211	36	C-7	29	CP-12-7	71
BV-400600	96	C-212	36	C-72	33	CP-12-8	71
BVA-1	97	C-213	36	C-73	33	CP-22	71
BVA-2	97	C-214	36	C-74	33	CP-22-3	71
BVA-3	97	C-215-B	60	C-75	33	CP-22-3,5	71
BVA-4	97	C-215-N	60	C-76	33	CP-22-4	71
BVC-150200	97	C-24	25	C-76-C	33	CP-22-4,5	71
BVC-185250	97	C-24-B	25	C-76-T	33	CP-22-5	71
BVC-200300	97	C-24-T	25	C-77	33	CP-22-6	71
BVC-250350	97	C-25	37	C-77-C	34	CP-22-7	71
BVC-300400	97	C-26	37	C-77-T	33	CP-22-8	71
BVC-350500	97	C-27	37	C-79	34	CP-2C	72
BVE-200300	96	C-28	37	C-7-B	28	CP-32	72
BVE-250350	96	C-30	38	C-81	28	CP-32-3	72
BVE-300400	96	C-300	22	C-82	28	CP-32-3,5	72
BVE-350450	96	C-301	22	C-87	34	CP-32-4	72
BVE-350600	96	C-302	22	C-87-A	34	CP-32-4,5	72
BVP-175250	96	C-303	22	C-88	34	CP-32-5	72
BVP-175300	96	C-304	22	C-89	34	CP-32-6	72
BVP-200250	96	C-305	22	C-9	35	CP-32-7	72
BVP-200300	96	C-306	22	C-90-AZ	26	CP-32-8	72
BVPO-200300	96	C-307	22	C-90-B	26	CP-8	71
BVPP-200300	96	C-30-P	38	C-90-R	26	CP-8-3	71

CP-8-3,5	71	ET-1-V	127	GIP-1/1-40	53	IT-109	198
CP-8-4	71	F		GIP-1/1-65	53	IT-11	125
CP-8-4,5	71	F-10	171	GIP-1/2-100	53	IT-110	198
CP-8-5	71	F-11	171	GIP-1/2-150	53	IT-11-1	125
CP-8-6	71	F-12	171	GIP-1/2-200	53	IT-30	126
CP-8-7	71	F-13	171	GIP-1/2-65	53	IT-30-MD	126
CP-8-8	71	F-14	171	GIP-2/1-20	53	IT-4	124
D		F-15	175	GIP-2/1-40	53	IT-4-MD	124
D-1	106	F-16	175	GIP-2/1-65	53	IT-4-X	125
D-11	107	F-17	171	GIS-325	54	IT-5-MD	122
D-2	106	F-20	175	GIS-530	54	IT-5-MDV	122
D-4-B	106	F-21	175	GIT-1/1	53	IT-6	122
D-4-C	106	F-22	175	GIT-1/2	53	IT-6-B	122
D-7	106	F-35	169	GIT-1/3	53	IT-6-E	122
D-7-N	106	F-36	169	GIT-1/4	53	IT-6-MD	123
D-8	106	F-40	169	GIT-1/6	53	IT-6-X	123
DA-1	81	G		GIT-1/9	53	IT-7-MD	123
DA-18	81	G-0	142	GIT-2/3	53	IT-8	123
DB-10	80	G-00	142	GITH-1/1	53	IT-8-MD	124
DB-6	80	G-1	142	GITH-1/2	53	IT-9-MD	124
DB-8	80	G-10	142	GITH-1/3	53	ITH-95	126
DD-10	80	G-11	142	GITH-1/4	53	ITR-125	126
DD-20	80	G-12	142	GITH-1/6	53	K-10	185
DD-8	80	G-13	142	GITH-2/3	53	K-104	185
DE-1	80	G-14	143	GP-1/1-100	51	K-104-5	185
DE-10	80	G-15	143	GP-1/1-150	51	K-105	185
DE-14	80	G-18	143	GP-1/1-200	51	K-105-5	185
DE-2	80	G-19	143	GP-1/1-65	51	K-106	185
DE-3	80	G-2	142	GP-1/2-100	51	K-106-5	185
DE-4	80	G-20	143	GP-1/2-150	51	K-124	185
DE-5	80	G-3	142	GP-1/2-200	51	K-124-5	185
DE-6	80	G-4	142	GP-1/2-65	51	K-125	185
DE-8	80	G-5	142	GP-1/3-100	51	K-125-5	185
DH-10	81	G-6	142	GP-1/3-150	51	K-126	185
DH-2,5	81	G-7	142	GP-1/3-200	51	K-126-5	185
DH-4	81	G-8	142	GP-1/3-65	51	K-15	185
DH-6	81	G-9	142	GP-1/4-100	51	K-154	185
DH-8	81	GI-1/1-100	52	GP-1/4-150	51	K-154-5	185
DR-0	78	GI-1/1-150	52	GP-1/4-200	51	K-155	185
DR-2	78	GI-1/1-20	52	GP-1/4-65	51	K-155-5	185
DR-3	78	GI-1/1-200	52	GP-1/6-100	51	K-156	185
DR-4	78	GI-1/1-40	52	GP-1/6-150	51	K-156-6	185
DR-6	78	GI-1/1-65	52	GP-1/6-200	51	K-15-P	185
DR-8	78	GI-1/2-100	52	GP-1/6-65	51	K-15-PS	185
DRH	78	GI-1/2-150	52	GP-1/9-100	51	K-15-S	185
DS-1	80	GI-1/2-20	52	GP-1/9-65	51	K-204	185
DS-2	80	GI-1/2-200	52	GP-2/1-200	51	K-204-5	185
DV	80	GI-1/2-40	52	GPPFP-1/1	51	K-205	185
DX-1	81	GI-1/2-65	52	GPPFP-1/2	51	K-205-5	185
DZ-2	80	GI-1/3-100	52	GPPFP-2/1	51	K-206	185
DZ-3	80	GI-1/3-150	52	GPT 1/1	51	K-206-5	185
DZ-4	80	GI-1/3-20	52	GPT 1/2	51	KBV-100	190
DZ-7	80	GI-1/3-200	52	GPT 1/3	51	KBV-150	190
E		GI-1/3-40	52	GPT 1/4	51	KBV-200	190
E-110	201	GI-1/3-65	52	GPT 1/6	51	KL-100	190
E-110-ECO	201	GI-1/4-100	52	GPT 1/9	51	KL-25	190
E-4	150	GI-1/4-150	52	GPT 2/1	51	KL-50	190
E-5	150	GI-1/4-20	52	H		KL-55	190
E-5-ECO	150	GI-1/4-200	52	H-120NV	146	KM-104	187
E-6	151	GI-1/4-40	52	H-12SR	146	KM-104-5	187
E-6-ECO	151	GI-1/4-65	52	H-140NV	146	KM-105	187
EC-1	113	GI-1/6-100	53	H-14SR	146	KM-105-5	187
EC-10	113	GI-1/6-150	53	H-16SR	146	KM-106	187
EC-105	115	GI-1/6-200	53	H-18SR	146	KM-106-5	187
EC-35	115	GI-1/9-100	53	H-20SR	146	KM-124	187
EC-50	116	GI-1/9-65	53	H-22R	146	KM-124-S	187
EC-5-45	114	GI-2/1-100	52	H-24R	146	KM-125	187
EC-55	115	GI-2/1-150	52	H-26R	146	KM-125-5	187
EC-710	199	GI-2/1-20	52	H-28R	146	KM-126	187
EC-711	199	GI-2/1-200	52	H-E10	146	KM-126-5	187
EC-712	199	GI-2/1-40	52	H-E12	146	KM-154	187
EC-713	199	GI-2/1-65	52	H-E14	146	KM-154-5	187
EC-714	199	GI-2/3-100	52	H-E16	146	KM-155	187
EC-715	199	GI-2/3-150	52	H-E18	146	KM-155-5	187
ECU-100	116	GI-2/3-20	52	H-P23	147	KM-156	187
ECU-15	199	GI-2/3-200	52	H-P23-C	147	KM-156-5	187
ECU-25	116	GI-2/3-40	52	H-P33	147	KM-204	187
ET-100	127	GI-2/3-65	52	H-P33-C	147	KM-204-5	187
ET-100-P	127	GI-2/4-20	48	I		KM-205	187
ET-100-S	127	GIFP-1/1	54	IT-10	125	KM-205-5	187
ET-108	198	GIFP-1/2	54	IT-10-1	125	KM-206	187
ET-15	127	GIFP-2/1	54	IT-103	198	KM-206-5	187
ET-1-A	127	GIFP-2/3	54	IT-105	198	KP-104	188
ET-1-AZ	127	GIP-1/1-100	53	IT-105-	198	KP-105	188
ET-1-B	127	GIP-1/1-150	53	IT-105-V	198	KP-106	188
ET-1-N	127	GIP-1/1-20	53	IT-106	198	KP-124	188
ET-1-R	127	GIP-1/1-200	53	IT-107	198	KP-125	188

K-S

KP-126	188	MH-5	136	MR-90	91	R-50	157
KP-154	188	MH-6	137	MRI-5	90	R-75	158
KP-155	188	MH-6-1	200	MRI-6	90	RB-4-A	150
KP-156	188	MH-7	137	MRIT-5	90	RB-4-AZ	150
KP-204	188	MH-7-1	200	MRIT-6	90	RB-4-B	150
KP-205	188	MH-8	136	MSE-10	78	RB-4-R	150
KP-206	188	MH-8-1	200	MT-152	98	RB-4-T	150
KP-250	189	MH-9	136	MT-192	98	RB-4-V	150
KP-300	189	MH-9-1	200	MT-270	99	R-CI	158
KP-350	189	MP-12MEC-M	64	MTB-15	99	R-CI110	157
KP-400	189	MP-12MEC-T	64	MTB-20	99	RE-5-B	151
KP-500	189	MP-22 EURO-M	65	MTB-27	99	RE-5-N	151
KTA-105	188	MP-22 EURO-T	65	MTM-1/2	99	RE-6-B	151
KTA-106	188	MP22 MEC-M	66	MTM-1/4	99	RE-6-N	151
KTA-107	188	MP-22 MEC-T	66	MV-10	93	RE-7	151
KTA-108	188	MP-22RE-M	68	MV-16	93	RE-8	151
L		MP-22RE-T	68	MV-21	93	R-PM	158
LM-1	111	MP-32 MEC-M	67	MV-6	93	R-PM110	157
LM-10	107	MP-32 MEC-T	67	MVS-100	94	RT-5-A	128
LM-10-P	107	MP-32RE-T	69	MVS-330	94	RT-5-AZ	128
LM-11	108	MP-8-M	70	MVS-960	93	RT-5-B	128
LM-1-1	108	MPE-18	84	N		RT-5-R	128
LM-1-2	108	MPP-10	85	N-20	152	RT-5-V	128
LM-1-3	108	MPQ-02	78	N-21	152	RT-6-A	128
LM-2	112	MPQ-MOZ-15	77	N-22	152	RT-6-AZ	128
LM-21	109	MPQ-MOZZARELLA	77	N-3	152	RT-6-B	128
LM-2-1	108	MPQV-5-M	79	N-30	152	RT-6-R	128
LM-21-1	111	MPQV-5-T	79	N-31	152	RT-6-V	128
LM-21-2	110	MR-1	88	N-32	152	S	
LM-21-3	110	MR-10	90	N-9	152	SB-1000	91
LM-21-4	110	MR-10-1	90	P		SB-1001	199
LM-22	109	MR-103	159	PB-1	103	SB-200	91
LM-2-2	108	MR-103-I	160	PB-10	105	SB-201	199
LM-23	109	MR-104	159	PB-11	105	SB-202	199
LM-23-1	111	MR-104-I	160	PB-12	104	SB-300	91
LM-23-2	110	MR-105	159	PB-1-M	103	SB-301	199
LM-24	109	MR-105-I	160	PB-2	103	SB-302	199
LM-25	111	MR-106	159	PB-21	103	SB-400	91
LM-26	109	MR-106-I	160	PB-21N	103	SB-400-ECO	91
LM-27	110	MR-11	90	PB-22	104	SB-401	199
LM-2-P	112	MR-110	159	PB-22N	104	SB-402	199
LM-4	112	MR-115-I	160	PB-23	104	SB-451	199
LM-5	112	MR-116	159	PB-23N	104	SB-500	91
LMP-4	112	MR-117	159	PB-24	104	SB-501	199
LMP-5	112	MR-119	159	PB-24N	104	SB-502	199
M		MR-119-I	160	PB-3	103	SB-600	91
MC-250-VOL	76	MR-12	90	PB-30	105	SB-601	199
MC-2530	76	MR-13	90	PB-40	105	SB-602	199
MC-3	82	MR-14	90	PB-50	105	SBM-500	92
MC-300-VOL	76	MR-15	92	PB-7	104	SBM-505	92
MC-5	83	MR-1-ECO	88	PB-70	105	SBPA-450	92
MC-8	83	MR-2	89	PB-8	104	SBPA-451	199
MC-CD-3	82	MR-20	89	PB-9	104	SBPA-600	92
MC-CD-5	82	MR-201	200	PH-3	138	SBPA-601	199
MC-CL-3	82	MR-201-ECO	200	PH-4	138	SCA-1600	73
MC-CL-5	82	MR-202	200	PH-5	138	SCA-1740	73
MC-CP-3	82	MR-202-ECO	200	PH-6	138	SCA-1750	73
MC-CP-5	82	MR-203	200	PH-7	138	SCA-1985	73
ME-L14	139	MR-204	200	PH-8	138	SCA-2120	73
ME-L5	139	MR-205	200	PR-20	145	SCA-2340	73
ME-L7	139	MR-206	200	PR-25	145	SCA-2520	73
ME-L8	139	MR-206-ECO	200	PS-60	138	SCA-2930	73
ME-L8V	139	MR-207	200	PS-70	138	SCO-1600	73
MH-1	136	MR-208	200	PS-80	138	SCO-1740	73
MH-10	137	MR-209	200	R		SCO-1750	73
MH-101	200	MR-210	200	R-100	158	SCO-1985	73
MH-102	200	MR-215	200	R-10-BE	154	SCO-2120	73
MH-103	201	MR-3	89	R-10-BEP	154	SCO-2340	73
MH-104	201	MR-30	89	R-10-G	154	SCO-2520	73
MH-105	200	MR-4	88	R-10-GP	154	SCO-2930	73
MH-107	200	MR-40	89	R-110	157	SHU-1600	73
MH-108	201	MR-45	89	R-20	154	SHU-1740	73
MH-109	201	MR-4-500	88	R-2020-AZ	156	SHU-1750	73
MH-110	201	MR-4-500-ECO	88	R-2020-R	156	SHU-1985	73
MH-111	201	MR-46	89	R-2020-V	156	SHU-2120	73
MH-112	201	MR-4-600	88	R-2021	156	SHU-2340	73
MH-13	137	MR-47	89	R-2032-AZ	156	SHU-2520	73
MH-15	137	MR-49	89	R-2032-R	156	SHU-2930	73
MH-1-R	136	MR-4-ECO	88	R-2032-V	156	SJ-10	141
MH-2	136	MR-5	90	R-2054-AZ	156	SJ-12	142
MH-20	138	MR-50	89	R-2054-R	156	SJ-15	141
MH-21	138	MR-500	160	R-2054-V	156	SJ-16	141
MH-22	138	MR-505	160	R-21	154	SJ-18	141
MH-23	138	MR-6	90	R-22	154	SJ-20	140
MH-25	138	MR-60	89	R-30	155	SJ-4	140
MH-3	136	MR-80	91	R-31	155	SJ-500	141
MH-4	136	MR-9	91	R-40	44	SJ-5-M	140

SJ-600	141	V-F644520PL	10	V-H2001003	8	V-H50403	8
SJ-600-R	141	V-F644525PL	10	V-H2001004	9	V-H50404	9
SJ-6-B	140	V-F705020PL	10	V-H2001005	9	V-H50405	9
SJ-8	140	V-F705025PL	10	V-H200251.5	8	V-H50501.5	8
SJ-9	140	V-F804020PL	10	V-H200252	8	V-H50502	8
SM-5	102	V-F804025PL	10	V-H200253	8	V-h50504	9
SM-6	102	V-F904520PL	10	V-H200254	9	V-H50505	9
SM-700	102	V-FA1005020PL	11	V-H200255	9	V-H50509	10
SPI-6	18	V-FA404020PL	11	V-H200331.5	8	V-H50603	8
T		V-FA454520PL	11	V-H200332	8	V-H60251.5	8
T-002	147	V-FA505020PL	11	V-H200333	8	V-H60252	8
T-003	147	V-FA604020PL	11	V-H200334	9	V-H60253	8
T-005	147	V-FA644520PL	11	V-H200335	9	V-H60254	9
T-007	147	V-FA705020PL	11	V-H25191.5	8	V-H60255	9
T-008	148	V-FA804020PL	11	V-H25192	8	V-H60301.5	8
T-009	147	V-FA904520PL	11	V-H25193	8	V-H60302	8
T-012	148	V-FI1005020PL	11	V-H25194	9	V-H60303	8
T-050	148	V-FI21005020PL	11	V-H25195	9	V-H60304	9
T-360	144	V-FI2404020PL	11	V-H30201.5	8	V-H60305	9
TA-002	148	V-FI2454520PL	11	V-H30202	8	V-H60331.5	8
TC-180	172	V-FI2505020PL	11	V-H30203	8	V-H60332	8
TC-200	172	V-FI2604020PL	11	V-H30204	9	V-H60333	8
TC-220	172	V-FI2644520PL	11	V-H30205	9	V-H60334	9
TC-240	172	V-FI2705020PL	11	V-H33191.5	8	V-H60335	9
TC-280	172	V-FI2804020PL	11	V-H33192	8	V-H60401.5	8
TF-200	172	V-FI2904520PL	11	V-H33193	8	V-H60402	8
TF-225	172	V-FI404020PL	11	V-H33194	9	V-H60403	8
TM-430	173	V-FI454520PL	11	V-H33195	9	V-H60404	9
TM-500	173	V-FI505020PL	11	V-H33331.5	8	V-H60405	9
TP-210	172	V-FI604020PL	11	V-H33332	8	V-H60409	10
TP-230	172	V-FI644520PL	11	V-H33333	8	V-H65455	9
TP-250	172	V-FI705020PL	11	V-H33334	9	V-H70505	9
TT-265	172	V-FI804020PL	11	V-H33335	9	V-H75251.5	8
V		V-FI904520PL	11	V-H3514	10	V-H75252	8
V-245459	12	V-FS453320PL	12	V-H355	10	V-H75253	8
V40305	9	V-FS454520PL	12	V-H359	10	V-H75254	9
V-A1005025E	3	V-FS604020PL	12	V-H4014	10	V-H75255	9
V-A1006015E	3	V-FS705020PL	12	V-H40201.5	8	V-H75331.5	8
V-A1206015E	3	V-G1005025E	6	V-H40202	8	V-H75332	8
V-A353525E	3	V-G1006015E	6	V-H40203	8	V-H75333	8
V-A404015E	3	V-G1206015E	6	V-H40204	9	V-H75334	9
V-A404025E	3	V-G372410E	6	V-H40205	9	V-H75335	9
V-A443215E	3	V-G372415E	6	V-H40251.5	8	V-H80405	9
V-A444425E	3	V-G37245E	6	V-H40252	8	V-H90455	9
V-A505025E	3	V-G442610E	6	V-H40253	8	V-HAGU14	10
V-A604015E	3	V-G442615E	6	V-H40254	9	V-HAGU5	10
V-A604025E	3	V-G442620E	6	V-H40255	9	V-HAGU9	10
V-A606015E	3	V-G443210E	6	V-H40301.5	8	V-HC10020	16
V-A644425E	3	V-G443215E	6	V-H40302	8	V-HC3320	16
V-A705025E	3	V-G443220E	6	V-H40303	8	V-HC5020	16
V-A804025E	3	V-G443225E	6	V-H40304	9	V-HG40302V	19
V-A806015E	3	V-G604015E	6	V-H40331.5	8	V-HRP-40302S	17
V-A884425E	3	V-G604025E	6	V-H403314	10	V-I1005025E	4
V-BPGD	7	V-G643215E	6	V-H40332	8	V-I21005025E	4
V-BPGDI	7	V-G644415E	6	V-H40333	8	V-I2404025E	4
V-ETI	7	V-G644420E	6	V-H40334	9	V-I2444425E	4
V-ETM	7	V-G644425E	6	V-H40335	9	V-I2505025E	4
V-F3315PL	10	V-G705025E	6	V-H40339	10	V-I2604025E	4
V-F3320PL	10	V-G804025E	6	V-H40401.5	8	V-I2644425E	4
V-F3325PL	10	V-G806015E	6	V-H40402	8	V-I2705025E	4
V-F333315PL	10	V-G883215E	6	V-H40403	8	V-I2804025E	4
V-F333320PL	10	V-G884425E	6	V-H40404	9	V-I2884425E	4
V-F333325PL	10	V-GOMA	3	V-H40405	9	V-I404025E	4
V-F3515PL	10	V-GUIA-40	3	V-H40409	10	V-I444425E	4
V-F3520PL	10	V-H100251.5	8	V-H405	10	V-I505025E	4
V-F3525PL	10	V-H100252	8	V-H409	10	V-I604025E	4
V-F353515PL	10	V-H100253	8	V-H45455	9	V-I644425E	4
V-F353520PL	10	V-H100254	9	V-H45459	10	V-I705025E	4
V-F353525PL	10	V-H100255	9	V-H50251.5	8	V-I804025E	4
V-F4020PL	10	V-H100331.5	8	V-H50252	8	V-I884425E	4
V-F4025PL	10	V-H100332	8	V-H50253	8	V-J3225E	5
V-F403315PL	10	V-H100333	8	V-H50254	9	V-J3525E	5
V-F403320PL	10	V-H100334	9	V-H50255	9	V-J3825E	5
V-F403325PL	10	V-H100335	9	V-H50301.5	8	V-J4425E	5
V-F404020PL	10	V-H100505	9	V-H50302	8	V-K40405	13
V-F404025PL	10	V-H150251.5	8	V-H50303	8	V-K40409	13
V-F4520PL	10	V-H150252	8	V-H50304	9	V-K45455	13
V-F4525PL	10	V-H150253	8	V-H50305	9	V-K45459	13
V-F454520PL	10	V-H150254	9	V-H50331.5	8	V-K50505	13
V-F454525PL	10	V-H150255	9	V-H503314	10	V-K50509	13
V-F503315PL	10	V-H150331.5	8	V-H50332	8	V-K540405	13
V-F503320PL	10	V-H150332	8	V-H50333	8	V-K540409	13
V-F503325PL	10	V-H150333	8	V-H50334	9	V-K545455	13
V-F505020PL	10	V-H150334	9	V-H50335	9	V-K54549	13
V-F505025PL	10	V-H150335	9	V-H50339	10	V-K550505	13
V-F604020PL	10	V-H2001001.5	8	V-H50401.5	8	V-K550509	13
V-F604025PL	10	V-H2001002	8	V-H50402	8	V-K560405	13

V-Z

V-K560409	13	V-MP10060XS	15	V-O404025E	5	X-0724	41
V-K570505	13	V-MP10070XC	15	V-O4410E	6	X-2500	40
V-K570509	13	V-MP10070XS	15	V-O4415E	6	X-2503	40
V-K60405	13	V-MP15060XC	15	V-O4420E	6	X-2504	40
V-K60409	13	V-MP15060XS	15	V-O4425E	6	X-2505	40
V-K70505	13	V-MP15070XC	15	V-O444410E	5	X-2509	40
V-K70509	13	V-MP15070XS	15	V-O444415E	5	X-2514	40
V-L240405	12	V-MP20060XC	15	V-O444420E	5	X-2515	41
V-L240409	12	V-MP20060XS	15	V-O444425E	5	X-2520	41
V-L245455	12	V-MP20070XC	15	V-O505025E	5	X-2530	41
V-L250505	12	V-MP20070XS	15	V-O606015E	5	X-2800	40
V-L250509	12	V-MX10050XC	16	V-PF	3	X-2801	40
V-L260405	12	V-MX10050XS	16	V-PORACE-40	2	X-2802	40
V-L260409	12	V-MX10060XC	16	V-PORACE-44	2	X-2803	40
V-L270505	12	V-MX10060XS	16	V-PORACE-50	2	X-2804	40
V-L270509	12	V-MX10070XC	16	V-PORMAD	2	X-2900	43
V-L40405	12	V-MX10070XS	16	V-PORPOLB	2	X-2901	43
V-L40409	12	V-MX15050XC	16	V-PORPOLR	2	X-2902	43
V-L45455	12	V-MX15050XS	16	V-PR	3	X-2903	43
V-L45459	12	V-MX15060XC	16	V-S443225E	4	X-2904	43
V-L50505	12	V-MX15060XS	16	V-S444425E	4	X-2905	43
V-L50509	12	V-MX15070XC	16	V-S604025E	4	X-2906	43
V-L60405	12	V-MX15070XS	16	V-S705025E	4	X-2907	43
V-L60409	12	V-MX20050XC	16	V-SP2B	19	X-2909	43
V-L70505	12	V-MX20050XS	16	V-SP2M	19	X-2910	43
V-L70509	12	V-MX20060XC	16	V-SP2R	19	X-6886	43
V-MC60505	19	V-MX20060XS	16	V-T50325	6	X-9005	43
V-MC60505-R	19	V-MX20070XC	16	V-T50355	6	Z	
V-MI10060C	14	V-MX20070XS	16	V-T50405	6	Z-10	202
V-MI10060S	14	V-O3210E	6	V-TP30202	19	Z-11	202
V-MI10070C	14	V-O3215E	6	V-TP35252	19	Z-11-U	202
V-MI10070S	14	V-O3220E	6	V-VALDILLA	3	Z-15	202
V-MI15060C	14	V-O3225E	6	W		Z-151	128
V-MI15060S	14	V-O323210E	5	W-120	117	Z-18	202
V-MI15070C	14	V-O323215E	5	W-240	117	Z-20	202
V-MI15070S	14	V-O323220E	5	W-28	118	Z-20-F	202
V-MI20060C	14	V-O323225E	5	W-60	117	Z-21	202
V-MI20060S	14	V-O3510E	6	W-80	117	Z-40	202
V-MI20070C	14	V-O3515E	6	W-81	118	Z-420-MD	129
V-MI20070S	14	V-O3520E	6	WI-110	120	Z-430-MD	129
V-MI5050	14	V-O3525E	6	WI-35	118	Z-440-MD	129
V-MI7050	14	V-O353510E	5	WI-60	120	Z-600	129
V-MIS	14	V-O353515E	5	WI-70	119	Z-700	129
V-MM10060XC	15	V-O353520E	5	WI-75	119	Z-780	129
V-MM10060XS	15	V-O353525E	5	WI-90	119	Z-911	130
V-MM10070XC	15	V-O3810E	6	X		Z-911-A	130
V-MM10070XS	15	V-O3815E	6	X-0024	41	Z-911-N	130
V-MM15060XC	15	V-O3820E	6	X-0100	42	Z-918	130
V-MM15060XS	15	V-O3825E	6	X-0101	42	Z-918-A	130
V-MM15070XC	15	V-O383810E	5	X-0102	42	Z-918-N	130
V-MM15070XS	15	V-O383815E	5	X-0200	42	Z-930	132
V-MM20060XC	15	V-O383820E	5	X-0201	42	Z-930-A	132
V-MM20060XS	15	V-O383825E	5	X-0202	42	Z-950	131
V-MM20070XC	15	V-O4025E	6	X-0203	42	Z-950-A	131
V-MM20070XS	15	V-O404015E	5	X-0204	42	Z-960	131
V-MP10060XC	15	V-O404020E	5	X-0210	42	Z-960-A	131

CONDICIONES GENERALES DE VENTA

PORTES

- La mercancía viajará **A PORTES PAGADOS** hasta su destino en pedidos superiores a 450 euros netos siempre que sea dentro de la península.
- Para Baleares la franquicia de portes será a partir de 600 euros netos.
- Para las Islas Canarias la franquicia de portes será a partir de 900 euros netos.
- Para Ceuta y Melilla la franquicia de portes será de 450 euros netos hasta puerto península.
- Para países de la CEE consultar.
- Para pedidos inferiores a las cantidades anteriormente descritas, Sacopisa ofrece cargar los portes en factura, viajando la mercancía por la empresa de transporte escogida por Sacopisa.

RECLAMACIONES

- La mercancía viajará por cuenta y riesgo del comprador debiendo notificar cualquier reclamación antes de 24

horas y haciéndolo constar ante la empresa de transportes.

- Rogamos hacer constar siempre en la entrega del transportista **"SALVO EXAMEN"** si no se puede revisar la mercancía en ese momento.

DEVOLUCIONES

- **NO SE ACEPTARÁN DEVOLUCIONES** sin antes comunicarlo a Sacopisa por teléfono o fax recibiendo el **CÓDIGO DE DEVOLUCIÓN**.
- El **CÓDIGO DE DEVOLUCIÓN** tiene que estar en un sitio visible del bulto y en su albarán.

PEDIDOS MÍNIMOS

- Pedidos mínimos 100 euros netos. Inferiores se cargaran euros gastos de administración.

CONFLICTOS

- En caso de litigio se resolverán en el juzgado correspondiente a la plaza del vendedor con renuncia de cualquier otro fuero.

GENERAL SALES CONDITIONS

- FREIGHT CONDITIONS WILL VARY IN ACCORDANCE WITH THE COUNTRY
- RETURNS ARE NOT ACCEPTED WITHOUT COMMUNICATE IT PREVIOUSLY BY PHONE, FAX OR E-MAIL
- IN CASE OF LAWSUIT, IT WILL BE SETTLED IN THE VENDOR CLOSER COURT, ANY OTHER JURISDICTION WILL BE REFUSED.

CONDITIONS GÉNÉRALES DE VENTE

- LES CONDITIONS DE TRANSPORT VARIENT SELON LE PAYS DE DESTINATION
 - AUCUN RETOUR SERA ACCEPTÉ SANS PRÉVENIR SACOPISA PAR TÉLÉPHONE, FAX OU E-MAIL
 - EN CAS DE LITIGE, SERA RÉTOLU DANS LA COUR PLUS PROCHE DU VENDEUR, RENONÇANT À TOUTE AUTRE JURISDICTION
-



SACOPISA S.L.

Pol. Can Casablanques, C/ Vallès, 5

Tel. +34 93 721 48 41 · +34 93 721 30 38 · Fax +34 93 721 40 24

08192 Sant Quirze del Vallès · Barcelona - España

Apartado de correos 349 – 08200 Sabadell

www.sacopisa.com

sacopisa@sacopisa.com | pedidos@sacopisa.com | export@sacopisa.com